

<p>TEST REPORT EN 50549-1:2019 Requirements for generating plants to be connected in parallel with distribution networks Part 1: Connection to a LV distribution network - Generating plants up to and including Type B</p>	
Report Reference No.....	190430035GZU-001
Date of issue	02 Dec 2019
Total number of pages.....	127 pages
Testing Laboratory	Intertek Testing Services Shenzhen Ltd. Guangzhou Branch
Address.....	Block E, No.7-2 Guang Dong Software Science Park, Caipin Road, Guangzhou Science City, GETDD, Guangzhou, China
Testing location/ address	Same as above
Tested by (name + signature).....	Jason Fu Technical Team Leader
Approved by (+ signature)	Tommy Zhong Technical Manager
Applicant's name	Shenzhen SOFAR SOLAR Co., Ltd.
Address.....	401, Building 4, AnTongDa Industrial Park, District 68, XingDong Community, XinAn Street, BaoAn District, Shenzhen, China
Test specification:	
Standard	EN 50549-1: February 2019
Test procedure.....	Type approval for type B
Non-standard test method.....	N/A
Test Report Form No.	EN 50549-1a
Test Report Form(s) Originator.....	Intertek Guangzhou
Master TRF	Dated 2019-05
This publication may be reproduced in whole or in part for non-commercial purposes as long as Intertek is acknowledged as copyright owner and source of the material. Intertek takes no responsibility for and will not assume liability for damages resulting from the reader's interpretation of the reproduced material due to its placement and context.	
Test item description	Solar Grid-tied Inverter
Trade Mark	
Manufacturer.....	Same as Applicant
Model/Type reference	SOFAR 20000TL-G2, SOFAR 25000TL-G2, SOFAR 30000TL-G2, SOFAR 33000TL-G2

Ratings	Model	SOFAR 20000TL- G2	SOFAR 25000TL- G2	SOFAR 30000TL- G2	SOFAR 33000TL- G2
	Max. DC input Voltage	1100Vdc			
	Operating MPPT voltage range	230Vdc – 960Vdc			
	PV Isc	30A*2	35A*2	37.5A*2	37.5A*2
	Max.input current	24A/24A	28A/28A	30A/30A	30A/30A
	Nominal AC output Power	20000W	25000W	30000W	33000W
	Max.Output Power	22000VA	27500VA	33000VA	36300VA
	Nominal output voltage	3/N/PE 230Vac/400Vac			
	Nominal output Frequency	50Hz			
	Power factor range	0.8Leading – 0.8 lagging			
	Safety level	Class I			
	Ingress Protection	IP 65			
	Operation Ambient Temperature	-25°C - +60°C			
	Software version	V2.20			

Summary of testing:																																											
<p>Tests performed (name of test and test clause):</p> <table border="1"> <thead> <tr> <th>EN 50549-1</th> <th>Test Description</th> </tr> </thead> <tbody> <tr> <td>4.4.2</td> <td>Operating frequency range</td> </tr> <tr> <td>4.4.3</td> <td>Minimal requirements for active power delivery at underfrequency</td> </tr> <tr> <td>4.4.4</td> <td>Continuous voltage operation range</td> </tr> <tr> <td>4.5.2</td> <td>Rate of change of frequency (ROCOF)</td> </tr> <tr> <td>4.5.3</td> <td>UVRT</td> </tr> <tr> <td>4.5.4</td> <td>OVRT</td> </tr> <tr> <td>4.6.1</td> <td>Power response to over frequency</td> </tr> <tr> <td>4.6.2</td> <td>Power response to under frequency</td> </tr> <tr> <td>4.7.2.2</td> <td>Q Capabilities (Power Factor) Q(U) Capabilities</td> </tr> <tr> <td>4.7.2.3.3</td> <td>Q Control. Voltage related control mode</td> </tr> <tr> <td>4.7.2.3.4</td> <td>Q Control Power related control modes</td> </tr> <tr> <td>4.7.3</td> <td>Voltage control by active power</td> </tr> <tr> <td>4.7.4</td> <td>Zero current mode</td> </tr> <tr> <td>4.8</td> <td>Harmonic emissions Flicker and voltage fluctuations DC injection</td> </tr> <tr> <td>4.9.3</td> <td>Interface protection</td> </tr> <tr> <td>4.9.4.2</td> <td>Islanding</td> </tr> <tr> <td>4.10.2</td> <td>Reconnection after tripping</td> </tr> <tr> <td>4.10.3</td> <td>Starting to generate electrical power</td> </tr> <tr> <td>4.11</td> <td>Active power reduction by setpoint and Ceasing active power (Logic interface)</td> </tr> <tr> <td>4.13</td> <td>Single fault tolerance of interface protection and interface switch</td> </tr> </tbody> </table>	EN 50549-1	Test Description	4.4.2	Operating frequency range	4.4.3	Minimal requirements for active power delivery at underfrequency	4.4.4	Continuous voltage operation range	4.5.2	Rate of change of frequency (ROCOF)	4.5.3	UVRT	4.5.4	OVRT	4.6.1	Power response to over frequency	4.6.2	Power response to under frequency	4.7.2.2	Q Capabilities (Power Factor) Q(U) Capabilities	4.7.2.3.3	Q Control. Voltage related control mode	4.7.2.3.4	Q Control Power related control modes	4.7.3	Voltage control by active power	4.7.4	Zero current mode	4.8	Harmonic emissions Flicker and voltage fluctuations DC injection	4.9.3	Interface protection	4.9.4.2	Islanding	4.10.2	Reconnection after tripping	4.10.3	Starting to generate electrical power	4.11	Active power reduction by setpoint and Ceasing active power (Logic interface)	4.13	Single fault tolerance of interface protection and interface switch	<p>Testing location:</p> <p>Intertek Testing Services Shenzhen Ltd. Guangzhou Branch</p> <p>Block E, No.7-2 Guang Dong Software Science Park, Caipin Road, Guangzhou Science City, GETDD, Guangzhou, China</p>
EN 50549-1	Test Description																																										
4.4.2	Operating frequency range																																										
4.4.3	Minimal requirements for active power delivery at underfrequency																																										
4.4.4	Continuous voltage operation range																																										
4.5.2	Rate of change of frequency (ROCOF)																																										
4.5.3	UVRT																																										
4.5.4	OVRT																																										
4.6.1	Power response to over frequency																																										
4.6.2	Power response to under frequency																																										
4.7.2.2	Q Capabilities (Power Factor) Q(U) Capabilities																																										
4.7.2.3.3	Q Control. Voltage related control mode																																										
4.7.2.3.4	Q Control Power related control modes																																										
4.7.3	Voltage control by active power																																										
4.7.4	Zero current mode																																										
4.8	Harmonic emissions Flicker and voltage fluctuations DC injection																																										
4.9.3	Interface protection																																										
4.9.4.2	Islanding																																										
4.10.2	Reconnection after tripping																																										
4.10.3	Starting to generate electrical power																																										
4.11	Active power reduction by setpoint and Ceasing active power (Logic interface)																																										
4.13	Single fault tolerance of interface protection and interface switch																																										
<p>Remark: for all clauses, the model SOFAR 33000TL-G2 is type tested.</p>																																											

Copy of marking plate

SOFAR Solar Grid-tied Inverter
SOLAR

Model No:	SOFAR 20000TL-G2
Max.DC Input Voltage	1100V
Operating MPPT Voltage Range	230~960V
Max. Input Current	24A/24A
Max. PV Isc	30A/30A
Nominal Grid Voltage	3/N/PE,400Vac
Max. Output Current	3x32A
Nominal Grid Frequency	50/60Hz
Nominal Output Power	20000W
Max. Output Power	22000VA
Power Factor	>0.99(adjustable +/-0.8)
Ingress Protection	IP65
Operating Temperature Range	-25°C~+60°C
Protective Class	Class I
Made in China	

Manufacturer : Shenzhen SOFAR SOLAR Co.,Ltd.
Address : 401, Building 4, An TongDa Industrial Park,
District 68, XingDong Community, XinAn Street,
BaoAn District, Shenzhen, China
VDE0126-1-1,VDE-AR-N4105,G99,IEC61727,
IEC62116,UTE C15-7 12-1,AS4777







SOFAR Solar Grid-tied Inverter
SOLAR

Model No:	SOFAR 25000TL-G2
Max.DC Input Voltage	1100V
Operating MPPT Voltage Range	230~960V
Max. Input Current	28A/28A
Max. PV Isc	35A/35A
Nominal Grid Voltage	3/N/PE,400Vac
Max. Output Current	3x40A
Nominal Grid Frequency	50/60Hz
Nominal Output Power	25000W
Max. Output Power	27500VA
Power Factor	>0.99(adjustable +/-0.8)
Ingress Protection	IP65
Operating Temperature Range	-25°C~+60°C
Protective Class	Class I
Made in China	

Manufacturer : Shenzhen SOFAR SOLAR Co.,Ltd.
Address : 401, Building 4, An TongDa Industrial Park,
District 68, XingDong Community, XinAn Street,
BaoAn District, Shenzhen, China
VDE0126-1-1,VDE-AR-N4105,G99,IEC61727,
IEC62116,UTE C15-7 12-1,AS4777



 Solar Grid-tied Inverter		 Solar Grid-tied Inverter	
Model No:	SOFAR 30000TL-G2	Model No:	SOFAR 33000TL-G2
Max.DC Input Voltage	1100V	Max.DC Input Voltage	1100V
Operating MPPT Voltage Range	230~960V	Operating MPPT Voltage Range	230~960V
Max. Input Current	30A/30A	Max. Input Current	30A/30A
Max. PV Isc	37.5A/37.5A	Max. PV Isc	37.5A/37.5A
Nominal Grid Voltage	3/N/PE,400Vac	Nominal Grid Voltage	3/N/PE,400Vac
Max. Output Current	3x48A	Max. Output Current	3x53A
Nominal Grid Frequency	50/60Hz	Nominal Grid Frequency	50/60Hz
Nominal Output Power	30000W	Nominal Output Power	33000W
Max. Output Power	33000VA	Max. Output Power	36300VA
Power Factor	>0.99(adjustable +/-0.8)	Power Factor	>0.99(adjustable +/-0.8)
Ingress Protection	IP65	Ingress Protection	IP65
Operating Temperature Range	-25°C~+60°C	Operating Temperature Range	-25°C~+60°C
Protective Class	Class I	Protective Class	Class I
Made in China		Made in China	
Manufacturer : Shenzhen SOFAR SOLAR Co.,Ltd. Address : 401, Building 4, An TongDa Industrial Park, District 68, XingDong Community,XinAn Street, BaoAn District, Shenzhen, China VDE0126-1-1,VDE-AR-N4105,G99,IEC61727, IEC62116,UTE C15-7 12-1,AS4777		Manufacturer : Shenzhen SOFAR SOLAR Co.,Ltd. Address : 401, Building 4, An TongDa Industrial Park, District 68, XingDong Community,XinAn Street, BaoAn District, Shenzhen, China VDE0126-1-1,VDE-AR-N4105,G99,IEC61727, IEC62116,UTE C15-7 12-1,AS4777	
			

Note:

1. The above markings are the minimum requirements required by the safety standard. For the final production samples, the additional markings which do not give rise to misunderstanding may be added.
2. Label is attached on the side surface of enclosure and visible after installation
3. The other model labels are identical with label above, except the model name and rating.

Test item particulars	
Temperature range	:
AC Overvoltage category	: <input type="checkbox"/> OVC I <input type="checkbox"/> OVC II <input checked="" type="checkbox"/> OVC III <input type="checkbox"/> OVC IV
DC Overvoltage category	: <input type="checkbox"/> OVC I <input checked="" type="checkbox"/> OVC II <input type="checkbox"/> OVC III <input type="checkbox"/> OVC IV
IP protection class	:
Possible test case verdicts:	
- test case does not apply to the test object	: N/A (Not applicable)
- test object does meet the requirement	: P (Pass)
- test object does not meet the requirement	: F (Fail)
Testing	
Date of receipt of test item	: 30 April 2019
Date (s) of performance of tests	: 07 Oct 2019 – 01 Dec 2019
General remarks:	
<p>The test results presented in this report relate only to the object tested. This report shall not be reproduced, except in full, without the written approval of the Issuing testing laboratory. "(see Enclosure #)" refers to additional information appended to the report. "(see appended table)" refers to a table appended to the report.</p> <p>When determining for test conclusion, measurement uncertainty of tests has been considered. This report is for the exclusive use of Intertek's Client and is provided pursuant to the agreement between Intertek and its Client. Intertek's responsibility and liability are limited to the terms and conditions of the agreement. Intertek assumes no liability to any party, other than to the Client in accordance with the agreement, for any loss, expense or damage occasioned by the use of this report. Only the Client is authorized to permit copying or distribution of this report and then only in its entirety. Any use of the Intertek name or one of its marks for the sale or advertisement of the tested material, product or service must first be approved in writing by Intertek. The observations and test results in this report are relevant only to the sample tested. This report by itself does not imply that the material, product, or service is or has ever been under an Intertek certification program. The test report only allows to be revised only within the report defined retention period unless standard or regulation was withdrawn or invalid.</p> <p>Throughout this report a point is used as the decimal separator.</p>	

General product information:

The Solar converter is a three-phase type.
The unit is providing EMC filtering at the output toward mains. The unit does not provide galvanic separation from input to output (transformerless). The output is switched off redundant by the high power switching bridge and two relays. This assures that the opening of the output circuit will also operate in case of one error.

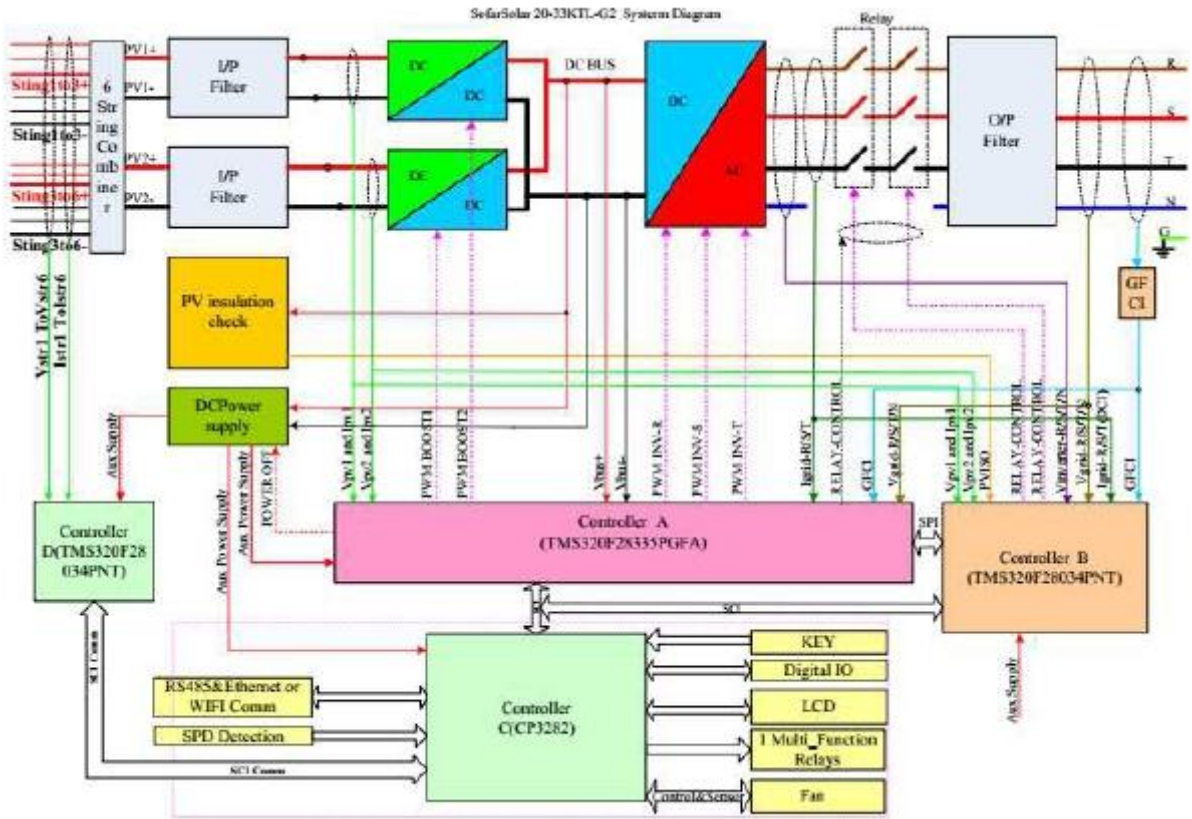

The internal control is redundant built. It consists of Main DSP(UC20) and slave DSP(UC73).
The Main DSP(UC20) can control the relays, measures voltage, and frequency, AC current with injected DC, insulation resistance and residual current, In addition it tests the array insulation resistance and the RCMU circuit before each start up.
The slave DSP(UC73) is using for detecting residual current, also can open the relays independently and communicate with Main DSP(UC20).
The unit provides two relays in series on Line conductors. When single-fault applied to one relay, alarm an error code in display panel, another redundant relay provides basic insulation maintained between the PV array and the mains. All the relays are tested before starting up. Both controllers (Main DSP(UC20), Slave DSP(UC73) can open the relays

The product was tested on:

Hardware version: V1.00
Software version: V2.20

Model differences:

The models SOFAR 20000TL-G2, SOFAR 25000TL-G2, SOFAR 30000TL-G2 and SOFAR 33000TL-G2 are almost identical in hardware except the shown in the following table and the output power derated by software.

The difference in hardware			
Item	SOFAR 20000TL-G2	SOFAR 25000TL-G2	SOFAR 30000TL-G2 / SOFAR 33000TL-G2
Number of PV terminal	2+2		3+3
Number of BUS capacitance	8 capacitors: 550V/110 μ F 2 capacitors: 1100V/40 μ F		10 capacitors: 550V/110 μ F 4 capacitors: 1100V/40 μ F
INV inductance	785 μ H		735 μ H
Combiner board	Not the board		Have the board
External fan	Not the board	2	3
Relay of output board	6pcs T9VV1K15-12S		3pcs AZSR250-2AE-12D

The tests had been performed on the SOFAR 33000TL-G2 is valid for the SOFAR 20000TL-G2, SOFAR 25000TL-G2, SOFAR 30000TL-G2.

Factory information:

Dongguan SOFAR SOLAR Co., Ltd

1F-6F, Building E, No.1 JinQi Road, Bihu Industrial Park, Wulian Village, Fenggang Town, Dongguan City

EN 50549-1:2019			
Clause	Requirement - Test	Result - Remark	Verdict
4	Requirements on generating plants		P
4.1	General	This report is only evaluated and tested for generating unit; The generating plant incorporated with the generating unit shall further consider this clause and sub-clause.	N/A
4.2	Connection scheme	Shall consider in final PGS	N/A
4.3	Choice of switchgear		P
4.3.1	General Switches shall be chosen based on the characteristics of the power system in which they are intended to be installed. For this purpose, the short circuit current at the installation point shall be assessed, taking into account, <i>inter alia</i> , the short circuit current contribution of the generating plant.	The short circuit current at the installation point shall be considered in final PGS	P
4.3.2	Interface switch Switches shall be power relays, contactors or mechanical circuit breakers each having a breaking and making capacity corresponding to the rated current of the generating plant and corresponding to the short circuit contribution of the generating plant. The short-time withstand current of the switching devices shall be coordinated with rated short circuit power at the point of connection. In case of loss of auxiliary supply power to the switchgear, a secure disconnection of the switch is required immediately. Where means of isolation (according to HD 60364-5-551) is not required to be accessible to the DSO at all times, automatic disconnection with single fault tolerance according to 4.13 shall be provided. The function of the interface switch might be combined with either the main switch or the generating unit switch in a single switching device. In case of a combination, the single switching device shall be compliant to the requirements of both, the interface switch and the combined main switch or generating unit switch. As a consequence, at least two switches in series shall be present between any generating unit and the POC.	The interface switch is constructed of redundancy, made up of two series relays and power and control separately. The EUT is a PV inverter, further evaluation refer to EN 62109-1 and EN 62109-2 with respect to the interface switch.	P
4.4	Normal operating range		P
4.4.1	General Generating plants when generating power shall have the capability to operate in the operating ranges specified below regardless of the topology and the settings of the interface protection.		P

EN 50549-1:2019			
Clause	Requirement - Test	Result - Remark	Verdict
4.4.2	<p>Operating frequency range The generating plant shall be capable of operating continuously when the frequency at the point of connection stays within the range of 49 Hz to 51 Hz. In the frequency range from 47 Hz to 52 Hz the generating plant should be capable of operating until the interface protection trips. Therefore, the generating plant shall at least be capable of operating in the frequency ranges, for the duration and for the minimum requirement as indicated in Table 1. Respecting the legal framework, it is possible that for some synchronous areas more stringent time periods and/or frequency ranges will be required by the DSO and the responsible party. Nevertheless, they are expected to be within the boundaries of the stringent requirement as indicated in Table 1 unless producer, DSO, TSO and responsible party agree on wider frequency ranges and longer durations.</p>	(See appended table 4.4.2)	P
4.4.3	<p>Minimal requirement for active power delivery at underfrequency A generating plant shall be resilient to the reduction of frequency at the point of connection while reducing the maximum active power as little as possible. The admissible active power reduction due to underfrequency is limited by the full line in Figure 5 and is characterized by a maximum allowed reduction rate of 10 % of P_{max} per 1 Hz for frequencies below 49,5 Hz. It is possible that a more stringent power reduction characteristic is required by the responsible party. Nevertheless this requirement is expected to be limited to an admissible active power reduction represented by the dotted line in Figure 5 which is characterised by a reduction rate of 2 % of the maximum power P_{max} per 1 Hz for frequencies below 49 Hz. If any technologies intrinsic design or ambient conditions have influence on the power reduction behaviour of the system, the manufacturer shall specify at which ambient conditions the requirements can be fulfilled and eventual limitations. The information can be provided in the format of a graph showing the intrinsic behaviour of the generating unit for example at different ambient conditions. The power reduction and the ambient conditions shall comply with the specification given by the responsible party. If the generating unit does not meet the power reduction at the specified ambient conditions, the producer and the responsible party shall agree on acceptable ambient conditions.</p>	(See appended table 4.4.3)	P

EN 50549-1:2019			
Clause	Requirement - Test	Result - Remark	Verdict
4.4.4	<p>Continuous operating voltage range When generating power, the generating plant shall be capable of operating continuously when the voltage at the point of connection stays within the range of 85 % U_n to 110 % U_n. Beyond these values the under and over voltage ride through immunity limits as specified in clause 4.5.3 and 4.5.4 shall apply. In case of voltages below U_n, it is allowed to reduce the apparent power to maintain the current limits of the generating plant. The reduction shall be as small as technically feasible. For this requirement all phase to phase voltages and in case a neutral is connected, additionally all phase to neutral voltages shall be evaluated.</p>	(See appended table 4.4.4)	P
4.5	Immunity to disturbances		P
4.5.1	<p>General In general, generating plants should contribute to overall power system stability by providing immunity towards dynamic voltage changes unless safety standards require a disconnection. The following clauses describe the required immunity for generating plants taking into account the connection technology of the generating modules. The following withstand capabilities shall be provided regardless of the settings of the interface protection.</p>		P
4.5.2	<p>Rate of change of frequency (ROCOF) immunity ROCOF immunity of a power generating plant means that the generating modules in this plant stay connected with the distribution network and are able to operate when the frequency on the distribution network changes with a specified ROCOF. The generating units and all elements in the generating plant that might cause their disconnection or impact their behaviour shall have this same level of immunity. The generating modules in a generating plant shall have ROCOF immunity for a ROCOF equal or exceeding the value specified by the responsible party. If no ROCOF immunity value is specified, the following ROCOF immunity shall apply, making distinction between generating technologies: • Non-synchronous generating technology: at least 2 Hz/s • Synchronous generating technology: at least 1 Hz/s The ROCOF immunity is defined with a sliding measurement window of 500 ms.</p>	(See appended table 4.5.2) For 2Hz/s	P
4.5.3	Under-voltage ride through (UVRT)		P

EN 50549-1:2019			
Clause	Requirement - Test	Result - Remark	Verdict
4.5.3.1	<p>General Generating modules classified as type B modules according to COMMISSION REGULATION 2016/631 shall comply with the requirements of 4.5.3.2 and 4.5.3.3. Generating modules classified as type A and smaller according to COMMISSION REGULATION 2016/631 should comply with these requirements. The actual behaviour of type A modules and smaller shall be specified in the connection agreement. The requirements apply to all kinds of faults (1ph, 2ph and 3ph).</p>		P
4.5.3.2	<p>Generating plant with non-synchronous generating technology Generating modules shall be capable of remaining connected to the distribution network as long as the voltage at the point of connection remains above the voltage-time curve of Figure 6. The voltage is relative to U_n. The smallest phase to neutral voltage, or if no neutral is present, the smallest phase to phase voltage shall be evaluated. The responsible party may define a different UVRT characteristic. Nevertheless, this requirement is expected to be limited to the most stringent curve as indicated in Figure 6. This means that the whole generating module has to comply with the UVRT requirement. This includes all elements in a generating plant: the generating units and all elements that might cause their disconnection. For the generating unit, this requirement is considered to be fulfilled if it stays connected to the distribution grid as long as the voltage at its terminals remains above the defined voltage-time diagram. After the voltage returns to continuous operating voltage range, 90 % of pre-fault power or available power whichever is the smallest shall be resumed as fast as possible, but at the latest within 1 s unless the DSO and the responsible party requires another value.</p>	(See appended table 4.5.3)	P
4.5.3.3	Generating plant with synchronous generating technology		N/A

EN 50549-1:2019			
Clause	Requirement - Test	Result - Remark	Verdict
4.5.4	<p>Over-voltage ride through (OVRT) Generating modules, except for micro-generating plants, shall be capable of staying connected to the distribution network as long as the voltage at the point of connection remains below the voltage-time curve of Figure 8. The highest phase to neutral voltage or if no neutral is present the highest phase to phase voltage shall be evaluated. This means that not only the generating units shall comply with this OVRT requirement but also all elements in a generating plant that might cause its disconnection..</p>	(See appended table 4.5.4)	P
4.6	<p>Active response to frequency deviation</p>		P
4.6.1	<p>Power response to overfrequency Generating plants shall be capable of activating active power response to overfrequency at a programmable frequency threshold f_1 at least between and including 50,2 Hz and 52 Hz with a programmable droop in a range of at least $s=2\%$ to $s=12\%$. The droop reference is P_{ref}. Unless defined differently by the responsible party: • $P_{ref}=P_{max}$, in the case of synchronous generating technology and electrical energy storage systems. • $P_{ref}=P_M$, the actual AC output power at the instant when the frequency reaches the threshold f_1, in the case of all other non-synchronous generating technology The power value calculated according to the droop is a maximum power limit. If e.g. the available primary power decreases during a high frequency period below the power defined by the droop function, lower power values are permitted. The generating plant shall be capable of activating active power response to overfrequency as fast as technically feasible with an intrinsic dead time that shall be as short as possible with a maximum of 2 s and with a step response time of maximum 30 s, unless another value is defined by the relevant party. An intentional delay shall be programmable to adjust the dead time to a value between the intrinsic dead time and 2 s.</p>	(See appended table 4.6.1)	P

EN 50549-1:2019			
Clause	Requirement - Test	Result - Remark	Verdict
	<p>After activation, the active power frequency response shall use the actual frequency at any time, reacting to any frequency increase or decrease according to the programmed droop with an accuracy of $\pm 10\%$ of the nominal power (see Figure 9). The resolution of the frequency measurement shall be ± 10 mHz or less. The accuracy is evaluated with a 1 min average value. At POC, loads if present in the producer's network might interfere with the response of the generating plant. The effect of loads is not considered for the evaluation of the accuracy, only the behaviour of the generating plant is relevant.</p>		P
	<p>Generating plants reaching their minimum regulating level shall, in the event of further frequency increase, maintain this power level constant unless the DSO and the responsible party requires to disconnect the complete plant or if the plant consists of multiple units by disconnecting individual units. The active power frequency response is only deactivated if the frequency falls below the frequency threshold f_1.</p> <p>If required by the DSO and the responsible party an additional deactivation threshold frequency f_{stop} shall be programmable in the range of at least 50 Hz to f_1. If f_{stop} is configured to a frequency below f_1 there shall be no response according to the droop in case of a frequency decrease (see Figure 10). The output power is kept constant until the frequency falls below f_{stop} for a configurable time t_{stop}.</p>		P
	<p>If at the time of deactivation of the active power frequency response the momentary active power PM is below the available active power PA, the active power increase of the generating plant shall not exceed the gradient defined in 4.10.2.</p> <p>Settings for the threshold frequency f_1, the droop and the intentional delay are provided by the DSO and the responsible party. If no settings are provided, the default settings in Table 2 should be applied.</p>		P
	<p>The enabling and disabling of the function and its settings shall be field adjustable and means shall be provided to protect these from unpermitted interference (e.g. password or seal) if required by the DSO and the responsible party.</p>	<p>The enabling and disabling can be access by communication interface</p>	P

EN 50549-1:2019			
Clause	Requirement - Test	Result - Remark	Verdict
	<p>Alternatively for the droop function described above, the following procedure is allowed for generating modules if permitted by the DSO and the responsible party:</p> <ul style="list-style-type: none"> • the generating units shall disconnect at randomized frequencies, ideally uniformly distributed between the frequency threshold f_1 and 52 Hz; • in case the frequency decreases again, the generating unit shall start its reconnection procedure once the frequency falls below the specific frequency that initiated the disconnection; for this procedure, the connection conditions described in 4.10 do not apply; • the randomization shall either be at unit level by changing the threshold over time, or on plant level by choosing different values for each unit within a plant, or on distribution system level if the DSO specifies a specific threshold for each plant or unit connected to its distribution system. 		P
	<p>EES units that are in charging mode at the time the frequency passes the threshold f_1 shall not reduce the charging power below P_M until frequency returns below f_1. Storage units should increase the charging power according to the configured droop. In case the maximum charging capacity is reached or to prevent any other risk of injury or damage of equipment, a reduction of charging power is permitted.</p>		P
4.6.2	<p>Power response to underfrequency EES units shall be capable of activating active power response to underfrequency. Other generating units/plants should be capable of activating active power response to underfrequency. If active power to underfrequency is provided by a generating plant/unit, the function shall comply with the requirements below. Active power response to underfrequency shall be provided when all of the following conditions are met:</p> <ul style="list-style-type: none"> • when generating, the generating unit is operating at active power below its maximum active power P_{max}; • when generating, the generating unit is operating at active power below the available active power P_A; • the voltages at the point of connection of the generating plant are within the continuous operating voltage range; and • when generating, the generating unit is operating with currents lower than its current limit. <p>In the case of EES units, active power frequency response to underfrequency shall be provided in charging and generating mode.</p>	(See appended table 4.6.2)	P

EN 50549-1:2019			
Clause	Requirement - Test	Result - Remark	Verdict
	<p>The active power response to underfrequency shall be delivered at a programmable frequency threshold f_1 at least between and including 49,8 Hz and 46,0 Hz with a programmable droop in a range of at least 2 % to 12 %. The droop reference P_{ref} is P_{max}. If the available primary power or a local set value increases during an underfrequency period above the power defined by the droop function, higher power values are permitted. The power value calculated according to the droop is therefore a minimum limit.</p> <p>The generating unit shall be capable of activating active power response to underfrequency as fast as technically feasible with an intrinsic dead time that shall be as short as possible with a maximum of 2 s and with a step response time of maximum 30 s unless another value is defined by the relevant party.</p> <p>An intentional initial delay shall be programmable to adjust the dead time to a value between the intrinsic dead time and 2 s.</p>		P
	<p>After activation, the active power frequency response shall use the actual frequency at any time, reacting to any frequency increase or decrease according to the programmed droop with an accuracy of ± 10 % of the nominal power. The accuracy is evaluated with a 1 min average value. The resolution of the frequency measurement shall be ± 10 mHz or less. At POC loads, if present in the producer's network, might interfere with the response of the generating plant. The effect of loads is not considered for the evaluation of the accuracy, only the behaviour of the generating plant is relevant.</p>		P
	<p>Generating modules reaching any of the conditions above during the provision of active power frequency response shall, in the event of further frequency decrease, maintain this power level constant.</p> <p>The active power frequency response is only deactivated if the frequency increases above the frequency threshold f_1.</p>		P
	<p>Settings for the threshold frequency f_1, the droop and the intentional delay are defined by the DSO and the responsible party, if no settings are provided, the function shall be disabled.</p>		P
	<p>The activation and deactivation of the function and its settings shall be field adjustable and means shall be provided to protect these from unpermitted interference (e.g. password or seal) if required by the DSO and the responsible party.</p>		P
4.7	Power response to voltage changes		P

EN 50549-1:2019			
Clause	Requirement - Test	Result - Remark	Verdict
4.7.1	<p>General When the contribution to voltage support is required by the DSO and the responsible party, the generating plant shall be designed to have the capability of managing reactive and/or active power generation according to the requirements of this clause.</p>		P
4.7.2	<p>Voltage support by reactive power</p>		P
4.7.2.1	<p>General Generating plants shall not lead to voltage changes out of acceptable limits. These limits should be defined by national regulation. Generating units and plants shall be able to contribute to meet this requirement during normal network operation. Throughout the continuous operating frequency (see 4.4.2) and voltage (see 4.4.4) range, the generating plant shall be capable to deliver the requirements stipulated below. Outside these ranges, the generating plant shall follow the requirements as good as technically feasible although there is no specified accuracy required.</p>		P
4.7.2.2	<p>Capabilities Unless specified differently below, for specific generating technologies, generating plants shall be able to operate with active factors as defined by the DSO and the responsible party from active factor = 0,90_{underexcited} to active factor= 0,90_{overexcited} The reactive power capability shall be evaluated at the terminals of the/each generating unit</p>	(See appended table 4.7.2.2)	P
	<p>CHP generating units with a capacity ≤ 150 kVA shall be able to operate with active factors as defined by the DSO from $\cos \varphi = 0,95_{\text{underexcited}}$ to $\cos \varphi = 0,95_{\text{overexcited}}$ Generating units with an induction generator coupled directly to the grid and used in generating plants above micro generating level, shall be able to operate with active factors as defined by the DSO from $\cos \varphi = 0,95_{\text{underexcited}}$ to $\cos \varphi = 1$ at the terminals of the unit. Deviating from 4.7.2.3 only the $\cos \varphi$ set point mode is required. Deviating from the accuracy requirements below, the accuracy is only required at active power P_D.</p>		N/A
	<p>Generating units with an induction generator coupled directly to the grid and used in micro generating plants shall operate with an active factor above 0,95 at the terminals of the generating unit. A controlled voltage support by reactive power is not required from this technology.</p>		N/A

EN 50549-1:2019			
Clause	Requirement - Test	Result - Remark	Verdict
	Generating units with linear generators, coupled directly and synchronously to the grid shall operate with an active factor above 0,95 at the terminals of the generating unit, and therefore a controlled voltage support by reactive power is not required from this technology.		N/A
	In case of different generating technologies with different requirements in one generating plant, each unit shall provide voltage support by reactive power as required for its specific technology. A compensation of one technology to reach the general plant requirement is not expected. The DSO and the responsible party may relax the above requirements. This relaxation might be general or specific for a certain generating plant or generating technology.		N/A
	All involved parties can expect to have access to information documenting the actual choices regarding active power capabilities relative to reactive power requirements and related to the power rating in the operating voltage range (see further in this clause). A P-Q Diagram shall be included in the product documentation of a generating unit. When operating above the apparent power threshold S_{min} equal to 10 % of the maximum apparent power S_{max} or the minimum regulating level of the generating plant, whichever is the higher value, the reactive power capability shall be provided with an accuracy of $\pm 2 \% S_{max}$. Up to this apparent power threshold S_{min} , deviations above 2 % are permissible; nevertheless the accuracy shall always be as good as technically feasible and the exchange of uncontrolled reactive power in this low-power operation mode shall not exceed 10 % of the maximum apparent power S_{max} . At POC loads, if present in the producer's network might interfere with the response of the generating plant. The effect of loads is not considered for the evaluation of the accuracy, only the behaviour of the generating plant is relevant. For generating units with a reactive power capability according Figure 12 the reactive power capability at active power P_D shall be at least according Figure 13. For generating units with a reduced reactive power capability Figure 13 is only applicable up to the maximum reactive power capability.	(See appended table 4.7.2.2)	P
4.7.2.3	Control modes		P

EN 50549-1:2019			
Clause	Requirement - Test	Result - Remark	Verdict
4.7.2.3.1	<p>General Where required, the form of the contribution to voltage control shall be specified by the DSO. The control shall refer to the terminals of the generating units The generating plant/unit shall be capable of operating in the control modes specified below within the limits specified in 4.7.2.2. The control modes are exclusive; only one mode may be active at a time.</p> <ul style="list-style-type: none"> • Q setpoint mode • Q (U) • Cos ϕ setpoint mode • Cos ϕ (P) <p>For mass market products, it is recommended to implement all control modes. In case of site specific generating plant design, only the control modes required by the DSO need to be implemented. The configuration, activation and deactivation of the control modes shall be field adjustable. For field adjustable configurations and activation of the active control mode, means shall be provided to protect the settings from unpermitted interference (e.g. password or seal) if required by the DSO. Which control modes are available in a product and how they are configured shall be stated in the product documentation.</p>		P
4.7.2.3.2	<p>Setpoint control modes Q setpoint mode and cos ϕ setpoint mode control the reactive power output and the cos ϕ of the output respectively, according to a set point set in the control of the generating plant/unit. In the case of change of the set point local or by remote control the settling time for the new set point shall be less than one minute.</p>	(See appended table 4.7.2.2)	P
4.7.2.3.3	<p>Voltage related control mode The voltage related control mode Q (U) controls the reactive power output as a function of the voltage. There is no preferred state of the art for evaluating the voltage. Therefore it is the responsibility of the generating plant designer to choose a method. One of the following methods should be used:</p> <ul style="list-style-type: none"> • the positive sequence component of the fundamental; • the average of the voltages measured independently for each phase to neutral or phase to phase; • phase independently the voltage of every phase to determine the reactive power for every phase. 	Method 2 used	P

EN 50549-1:2019			
Clause	Requirement - Test	Result - Remark	Verdict
	<p>For voltage related control modes, a characteristic with a minimum and maximum value and three connected lines according to Figure 16 shall be configurable.</p> <p>In addition to the characteristic, further parameters shall be configurable:</p> <ul style="list-style-type: none"> • The dynamics of the control shall correspond with a first order filter having a time constant that is configurable in the range of 3 s to 60 s. 	(See appended table 4.7.2.3.3)	P
	<p>To limit the reactive power at low active power two methods shall be configurable:</p> <ul style="list-style-type: none"> • a minimal $\cos \varphi$ shall be configurable in the range of 0-0,95; • two active power levels shall be configurable both at least in the range of 0 % to 100 % of P_D. The lock-in value turns the Q(U) mode on, the lock-out value turns Q(U) off. If lock-in is larger than lock-out a hysteresis is given. See also Figure 14. The static accuracy shall be in accordance with 4.7.2.2. The dynamic accuracy shall be in accordance with Figure 15 with a maximum tolerance of +/- 5% of P_D plus a time delay of up to 3 seconds deviating from an ideal first order filter response. 		P
4.7.2.3.4	<p>Power related control mode</p> <p>The power related control mode $\cos \varphi$ (P) controls the $\cos \varphi$ of the output as a function of the active power output.</p> <p>For power related control modes, a characteristic with a minimum and maximum value and three connected lines shall be configurable in accordance with Figure 16.</p> <p>Resulting from a change in active power output a new $\cos \varphi$ set point is defined according to the set characteristic. The response to a new $\cos \varphi$ set value shall be as fast as technically feasible to allow the change in reactive power to be in synchrony with the change in active power. The new reactive power set value shall be reached at the latest within 10 s after the end value of the active power is reached. The static accuracy of each $\cos \varphi$ set point shall be according to 4.7.2.2.</p>	(See appended table 4.7.2.3.4)	P

EN 50549-1:2019			
Clause	Requirement - Test	Result - Remark	Verdict
4.7.3	<p>Voltage related active power reduction In order to avoid disconnection due to overvoltage protection (see 4.9.2.3 and 4.9.2.4), generating plants/units are allowed to reduce active power output as a function of this rising voltage. The final implemented logic can be chosen by the manufacturer. Nevertheless, this logic shall not cause steps or oscillations in the output power. The power reduction caused by such a function may not be faster than an equivalent of a time constant $\tau = 3 \text{ s}$ (= 33%/s at a 100% change). The enabling and disabling of the function shall be field adjustable and means have to be provided to protect the setting from unpermitted interference (e.g. password or seal) if required by the DSO.</p>	This function is chosen by manufacturer	P
4.7.4	<p>Short circuit current requirements on generating plants</p>		P
4.7.4.1	<p>General The following clauses describe the required short circuit current contribution for generating plants taking into account the connection technology of the generating modules. Generating modules classified as type B modules according to COMMISSION REGULATION 2016/631 shall comply with the requirements of 4.7.4.2 and 4.7.4.3. Generating modules classified as type A according to COMMISSION REGULATION 2016/631 should comply with these requirements. The actual behaviour of type A modules shall be specified in the connection agreement.</p>		P
4.7.4.2	<p>Generating plant with non-synchronous generating technology</p>		P
4.7.4.2.1	<p>Voltage support during faults and voltage steps In general no voltage support during faults and voltage steps is required from generating plants connected in LV distribution networks as the additional reactive current is expected to interfere with grid protection equipment. If the responsible party requires voltage support during faults and voltage steps for generating plants of type B connected to LV distribution grids, the clause 4.7.4 of EN 50549-2 applies.</p>	Only EN 50549-1 applies, if required by the responsible party for additional reactive current, the EN 50549-2 shall be applied.	P

EN 50549-1:2019			
Clause	Requirement - Test	Result - Remark	Verdict
4.7.4.2.2	<p>Zero current mode for converter connected generating technology</p> <p>If UVRT capability (see 4.5.3) is provided additional to the requirements of 4.5, generating units connected to the grid by a converter shall have the capability to reduce their current as fast as technically feasible down to or below 10 % of the rated current when the voltage is outside of a static voltage range. Generating units based on a doubly fed induction machine can only reduce the positive sequence current below 10 % of the rated current. Negative sequence current shall be tolerated during unbalanced faults. In case this current reduction is not sufficient, the DSO should choose suitable interface protection settings.</p> <p>The static voltage range shall be adjustable from 20 % to 100 % of U_n for the undervoltage boundary and from 100 % to 130 % of U_n for the overvoltage boundary. The default setting shall be 50% of U_n for the undervoltage boundary and 120% of U_n for the overvoltage boundary. Each phase to neutral voltage or if no neutral is present each phase to phase voltage shall be evaluated. At voltage re-entry into the voltage range, 90% of pre-fault power or available power, whichever is the smallest, shall be resumed as fast as possible, but at the latest according to 4.5.3 and 4.5.4.</p> <p>All described settings are defined by the DSO and the responsible party. If no settings are provided, the function shall be disabled.</p> <p>The enabling and disabling and the settings shall be field adjustable and means have to be provided to protect these from unpermitted interference (e.g. password or seal) if required by the DSO.</p>	<p>The test is performed together with the clause 4.5.3 and 4.5.4</p> <p>Default setting for testing.</p>	P
4.7.4.2.3	<p>Induction generator based units</p> <p>In general no voltage support during faults and voltage steps is required from generating plants connected in LV distribution networks as the additional reactive current is expected to interfere with grid protection equipment. If the responsible party requires voltage support during faults and voltage steps for generating plants of type B connected to LV distribution grids, the clause 4.7.4 of EN50549-2 applies.</p>		N/A

EN 50549-1:2019			
Clause	Requirement - Test	Result - Remark	Verdict
4.7.4.3	<p>Generating plant with synchronous generating technology - Synchronous generator based units</p> <p>In general no voltage support during faults and voltage steps is required from generating plants connected in LV distribution networks as the additional reactive current is expected to interfere with grid protection equipment. If the responsible party requires voltage support during faults and voltage steps for generating plants of type B connected to LV distribution grids, the clause 4.7.4 of EN50549-2 applies.</p>		N/A
4.8	<p>EMC and power quality</p> <p>Similar to any other apparatus or fixed installation, generating units shall comply with the requirements on electromagnetic compatibility established in Directive 2014/30/EU or 2014/53/EU, whichever applies.</p> <p>EMC limits and tests, described in EN 61000 series, have been traditionally developed for loads, without taking into account the particularities of generating units, such as their capability to create overvoltages or high frequency disturbances due to the presence of power converters, which were either impossible or less frequent in case of loads.</p>	The units have declared to comply with Directive 2014/30/EU or 2014/53/EU	P
4.9	<p>Interface protection</p>		P
4.9.1	<p>General</p> <p>According to HD 60364-5-551:2010, 551.7.4, means of automatic switching shall be provided to disconnect the generating plant from the distribution network in the event of loss of that supply or deviation of the voltage or frequency at the supply terminals from values declared for normal supply. This automatic means of disconnection has following main objectives:</p> <ul style="list-style-type: none"> • prevent the power production of the generating plant to cause an overvoltage situation in the distribution network it is connected to. Such overvoltages could result in damages to the equipment connected to the distribution network as well as the distribution network itself; • detect unintentional island situations and disconnect the generating plant in this case. This is contributing to prevent damage to other equipment, both in the producers' installations and the distribution network due to out of phase re-closing and to allow for maintenance work after an intentional disconnection of a section of the distribution network; • assist in bringing the distribution network to a controlled state in case of voltage or frequency deviations beyond corresponding regulation values. 		P

EN 50549-1:2019			
Clause	Requirement - Test	Result - Remark	Verdict
	<ul style="list-style-type: none"> • disconnect the generating plant from the distribution network in case of faults internal to the power generating plant. Protection against internal faults (short-circuits) shall be coordinated with network protection, according to DSO protection criteria. Protection against e.g. overload, electric shock and against fire hazards shall be implemented additionally according to HD 60364-1 and local requirements; • prevent damages to the generating unit due to incidents (e.g. short circuits) on the distribution network <p>Interface protections may contribute to preventing damage to the generating units due to out-of-phase reclosing of automatic reclosing which may happen after some hundreds of ms. However, in some countries some technologies of generating units are explicitly required to have an appropriate immunity level against the consequences of out-of-phase reclosing.</p> <p>The type of protection and the sensitivity and operating times depend upon the protection and the characteristics of the distribution network.</p> <p>A wide variety of approaches to achieve the above mentioned objectives is used throughout Europe. Besides the passive observation of voltage and frequency other active and passive methods are available and used to detect island situations. The requirements given in this clause are intended to provide the necessary functions for all known approaches as well as to give guidance in their use. Which functions are available in a product shall be stated in the product documentation.</p>		P
	<p>The interface protection system shall comply with the requirements of this European Standard, the available functions and configured settings shall comply with the requirements of the DSO and the responsible party. In any case, the settings defined shall be understood as the values for the interface protection system, i.e. where there is a wider technical capability of the generation module, it shall not be withheld by the settings of the protections (other than the interface protection).</p> <p>For micro generating plants, the interface protection system and the point of measurement might be integrated into the generating units. For generating plants with nominal current above 16 A the DSO may define a threshold above which the interface protection system shall be realized as a dedicated device and not integrated into the generating units.</p>	<p>Integrated into the generating units</p> <p>If specified by country requirement, the interface protection shall not integrate</p>	P

EN 50549-1:2019			
Clause	Requirement - Test	Result - Remark	Verdict
	<p>to place the protection system as close to the point of connection as possible, to avoid tripping due to overvoltages resulting from the voltage rise within the producer's network;</p> <ul style="list-style-type: none"> • to allow for periodic field tests. In some countries periodic field tests are not required if the protection system meets the requirements of single fault safety. <p>The interface protection relay acts on the interface switch. The DSO may require that the interface protection relay acts additionally on another switch with a proper delay in case the interface switch fails to operate.</p> <p>In case of failure of the power supply of the interface protection, the interface protection shall trigger the interface switch without delay. An uninterruptible power supply may be required by the DSO, for instance in case of UVRT capability, delay in protection etc.</p> <p>In case of field adjustable settings of threshold and operation time, means shall be provided to protect the settings from unpermitted interference (e.g. password or seal) if required by the DSO.</p>		P
4.9.2	Void		--
4.9.3	Requirements on voltage and frequency protection	(See appended table 4.9.3)	P
4.9.3.1	<p>General</p> <p>Part or all of the following described functions may be required by the DSO and the responsible party. The protection functions shall evaluate at least all phases where generating units, covered by this protection system, are connected to.</p> <p>In case of three phase generating units/plants and in all cases when the protection system is implemented as an external protection system in a three phase power supply system, all phase to phase voltages and, if a neutral conductor is present, all phase to neutral voltages shall be evaluated. The frequency shall be evaluated on at least one of the voltages.</p>		P

EN 50549-1:2019			
Clause	Requirement - Test	Result - Remark	Verdict
	<p>If multiple signals (e.g. 3 phase to phase voltages) are to be evaluated by one protection function, this function shall evaluate all of the signals separately. The output of each evaluation shall be OR connected, so that if one signal passes the threshold of a function, the function shall trip the protection in the specified time.</p> <p>The minimum required accuracy for protection is:</p> <ul style="list-style-type: none"> • for frequency measurement $\pm 0,05$ Hz; • for voltage measurement ± 1 % of U_n. • The reset time shall be ≤ 50ms • The interface protection relay shall not conduct continuous starting and disengaging operations of the interface protection relay. Therefore a reasonable reset ratio shall be implemented which shall not be zero but be below 2% of nominal value for voltage and below 0,2Hz for frequency. 		P
4.9.3.2	<p>Undervoltage protection [27]</p> <p>The protection shall comply with EN 60255-127. The evaluation of the r.m.s. or the fundamental value is allowed.</p> <p>Undervoltage protection may be implemented with two completely independent protection thresholds, each one able to be activated or not. The standard adjustment ranges are as follows.</p> <p>Undervoltage threshold stage 1 [27 <]:</p> <ul style="list-style-type: none"> • Threshold $(0,2 - 1) U_n$ adjustable by steps of $0,01 U_n$ • Operate time $(0,1 - 100)$ s adjustable in steps of $0,1$ s <p>Undervoltage threshold stage 2 [27 < <]:</p> <ul style="list-style-type: none"> • Threshold $(0,2 - 1) U_n$ adjustable by steps of $0,01 U_n$ • Operate time $(0,1 - 5)$ s adjustable in steps of $0,05$ s <p>The undervoltage threshold stage 2 is not applicable for micro-generating plants</p>		P
4.9.3.3	<p>Overvoltage protection [59]</p> <p>The protection shall comply with EN 60255-127. The evaluation of the r.m.s. or the fundamental value is allowed.</p> <p>Overvoltage protection may be implemented with two completely independent protection thresholds, each one able to be activated or not. The standard adjustment ranges are as follows.</p> <p>Overvoltage threshold stage 1 [59 >]:</p> <ul style="list-style-type: none"> • Threshold $(1,0 - 1,2) U_n$ adjustable by steps of $0,01 U_n$ • Operate time $(0,1 - 100)$ s adjustable in steps of $0,1$ s <p>Overvoltage threshold stage 2 [59 > >]:</p> <ul style="list-style-type: none"> • Threshold $(1,0 - 1,30) U_n$ adjustable by steps of $0,01 U_n$ • Operate time $(0,1 - 5)$ s adjustable in steps of $0,05$ s 		P

EN 50549-1:2019			
Clause	Requirement - Test	Result - Remark	Verdict
4.9.3.4	<p>Overvoltage 10 min mean protection</p> <p>The calculation of the 10 min value shall comply with the 10 min aggregation of EN 61000-4-30 Class S, but deviating from EN 61000-4-30 as a moving window is used. Therefore the function shall be based on the calculation of the square root of the arithmetic mean of the squared input values over 10 min. The calculation of a new 10 min value at least every 3 s is sufficient, which is then to be compared with the threshold value.</p> <ul style="list-style-type: none"> • Threshold (1,0 – 1,15) U_n adjustable by steps of 0,01 U_n • Start time $\leq 3s$ not adjustable • Time delay setting = 0 ms 		P
4.9.3.5	<p>Underfrequency protection [81 <]</p> <p>Underfrequency protection may be implemented with two completely independent protection thresholds, each one able to be activated or not. The standard adjustment ranges are as follows.</p> <p>Underfrequency threshold stage 1 [81 <]:</p> <ul style="list-style-type: none"> • Threshold (47,0 – 50,0) Hz adjustment by steps of 0,1 Hz • Operate time (0,1 – 100) s adjustable in steps of 0,1 s <p>Underfrequency threshold stage 2 [81 < <]:</p> <ul style="list-style-type: none"> • Threshold (47,0 – 50,0) Hz adjustment by steps of 0,1 Hz • Operate time (0,1 – 5) s adjustable in steps of 0,05 s <p>In order to use narrow frequency thresholds for islanding detection (see 4.9.3.3) it may be required to have the ability to activate and deactivate a stage by an external signal.</p> <p>The frequency protection shall function correctly in the input voltage range between 20 % U_n and 120 % U_n and shall be inhibited for input voltages of less than 20 % U_n.</p> <p>Under 0,2 U_n the frequency protection is inhibited. Disconnection may only happen based on undervoltage protection.</p>		P

EN 50549-1:2019			
Clause	Requirement - Test	Result - Remark	Verdict
4.9.3.6	<p>Overfrequency protection [81 >] Overfrequency protection may be implemented with two completely independent protection thresholds, each one able to be activated or not. The standard adjustment ranges are as follows. Overfrequency threshold stage 1 [81 >]:</p> <ul style="list-style-type: none"> • Threshold (50,0 - 52,0) Hz adjustment by steps of 0,1 Hz • Operate time (0,1 – 100) s adjustable in steps of 0,1 s <p>Overfrequency threshold stage 2 [81 > >]:</p> <ul style="list-style-type: none"> • Threshold (50,0 - 52,0) Hz adjustment by steps of 0,1 Hz • Operate time (0,1 - 5) s adjustable in steps of 0,05 s <p>In order to use narrow frequency thresholds for islanding detection (see4.9.3.3) it may be required to have the ability to activate and deactivate a stage by an external signal. The frequency protection shall function correctly in the input voltage range between 20 % U_n and 120 % U_n and shall be inhibited for input voltages of less than 20 % U_n.</p>		P
4.9.4	Means to detect island situation		P
4.9.4.1	<p>General sides the passive observation of voltage and frequency further means to detect an island may be required by the DSO. Detecting islanding situations shall not be contradictory to the immunity requirements of 4.5. Commonly used functions include:</p> <ul style="list-style-type: none"> • Active methods tested with a resonant circuit; • ROCOF tripping; • Switch to narrow frequency band; • Vector shift • Transfer trip. <p>Only some of the methods above rely on standards. Namely for ROCOF tripping and for the detection of a vector shift, also called a vector jump, currently no European Standard is available.</p>		P
4.9.4.2	<p>Active methods tested with a resonant circuit These are methods which pass the resonant circuit test for PV inverters according to EN 62116.</p>	(See appended table 4.9.4.2)	P

EN 50549-1:2019			
Clause	Requirement - Test	Result - Remark	Verdict
4.9.4.3	<p>Switch to narrow frequency band (see Annex E and Annex F) In case of local phenomena (e.g. a fault or the opening of circuit breaker along the line) the DSO in coordination with the responsible party may require a switch to a narrow frequency band to increase the interface protection relay sensitivity. In the event of a local fault it is possible to enable activation of the restrictive frequency window (using the two underfrequency/overfrequency thresholds described in 4.9.2.5 and 4.9.2.6) correlating its activation with another additional protection function. If required by the DSO, a digital input according to 4.9.4 shall be available to allow the DSO the activation of a restrictive frequency window by communication.</p>		P
4.9.5	<p>Digital input to the interface protection If required by the DSO, the interface protection shall have at least two configurable digital inputs. These inputs can for example be used to allow transfer trip or the switching to the narrow frequency band.</p>		P
4.10	Connection and starting to generate electrical power		P
4.10.1	<p>General Connection and starting to generate electrical power is only allowed after voltage and frequency are within the allowed voltage and frequency ranges for at least the specified observation time. It shall not be possible to overrule these conditions. Within these voltage and frequency ranges, the generating plant shall be capable of connecting and starting to generate electrical power. The setting of the conditions depends on whether the connection is due to a normal operational startup or an automatic reconnection after tripping of the interface protection. In case the settings for automatic reconnection after tripping and starting to generate power are not distinct in a generating plant, the tighter range and the start-up gradient shall be used. The frequency range, the voltage range, the observation time and the power gradient shall be field adjustable. For field adjustable settings, means shall be provided to protect the settings from unpermitted interference (e.g. password or seal) if required by the DSO.</p>		P

EN 50549-1:2019			
Clause	Requirement - Test	Result - Remark	Verdict
4.10.2	<p>Automatic reconnection after tripping</p> <p>The frequency range, the voltage range, the observation time shall be adjustable in the range according to Table 3 column 2. If no settings are specified by the DSO and the responsible party, the default settings for the reconnection after tripping of the interface protection are according to Table 3 column 3.</p> <p>After reconnection, the active power generated by the generating plant shall not exceed a specified gradient expressed as a percentage of the active nominal power of the unit per minute. If no gradient is specified by the DSO and the responsible party, the default setting is 10 % P_N/min. Generating modules for which it is technically not feasible to increase the power respecting the specified gradient over the full power range may connect after 1 min to 10 min (randomized value, uniformly distributed) or later.</p>	(See appended table 4.10.2)	P
4.10.3	<p>Starting to generate electrical power</p> <p>The frequency range, the voltage range, the observation time shall be adjustable in the range according to Table 4 column 2. If no settings are specified by the DSO and the responsible party, the default settings for connection or starting to generate electrical power due to normal operational startup or activity are according to Table 4 column 3.</p> <p>If applicable, the power gradient shall not exceed the maximum gradient specified by the DSO and the responsible party. Heat driven CHP generating units do not need to keep a maximum gradient, since the start up is randomized by the nature of the heat demand.</p> <p>For manual operations performed on site (e.g. for the purpose of initial start-up or maintenance) it is permitted to deviate from the observation time and ramp rate.</p>	(See appended table 4.10.3) Default settings are applied	P
4.10.4	<p>Synchronization</p> <p>Synchronizing a generating plant/unit with the distribution network shall be fully automatic i.e. it shall not be possible to manually close the switch between the two systems to carry out synchronization.</p>		P
4.11	Ceasing and reduction of active power on set point		P
4.11.1	<p>Ceasing active power</p> <p>Generating plants with a maximum capacity of 0,8 kW or more shall be equipped with a logic interface (input port) in order to cease active power output within five seconds following an instruction being received at the input port. If required by the DSO and the responsible party, this includes remote operation.</p>	(See appended table 4.11)	P

EN 50549-1:2019			
Clause	Requirement - Test	Result - Remark	Verdict
4.11.2	<p>Reduction of active power on set point</p> <p>For generating modules of type B, a generating plant shall be capable of reducing its active power to a limit value provided remotely by the DSO. The limit value shall be adjustable in the complete operating range from the maximum active power to minimum regulating level.</p> <p>The adjustment of the limit value shall be possible with a maximum increment of 10% of nominal power.</p> <p>A generation unit/plant shall be capable of carrying out the power output reduction to the respective limit within an envelope of not faster than 0,66 % P_n/ s and not slower than 0,33 % P_n/ s with an accuracy of 5 % of nominal power. Generating plants are permitted to disconnect from the network at a limit value below it minimum regulating level. If required by the DSO, this includes remote operation.</p>	(See appended table 4.11)	P

EN 50549-1:2019			
Clause	Requirement - Test	Result - Remark	Verdict
4.12	<p>Remote information exchange Generating plants whose power is above a threshold to be determined by the DSO and the responsible party shall have the capacity to be monitored by the DSO or TSO control centre or control centres as well as receive operation parameter settings for the functions specified in this European Standard from the DSO or TSO control centre or control centres. This information exchange is aimed at allowing the DSO and/or the TSO to improve, optimize and make safer the operation of their respective networks. The remote monitoring and operation parameter settings system that may be used by the DSO is not aimed at replacing the manual and automatic control means implemented by the generating plant operator to control the operation of the generating plant. It should not interact directly with the power generation equipment and the switching devices of the generating plant. It should interact with the operation and control system of the generating plant. In principle, standardized communication should be used. It is recommended that in case of using protocols for signal transmission used between the DSO or TSO control centre or control centres and the generating plant, relevant technical standards (e.g. EN 60870-5-101, EN 60870-5-104, EN 61850 and in particular EN 61850-7-4, EN 61850-7-420, IEC/TR 61850-90-7, as well as EN 61400-25 for wind turbines and relevant parts of IEC 62351 for relevant security measures) are recognized. Alternative protocols can be agreed between the DSO and the producer. These protocols include hardwired digital input/output and analogue input/output provided locally by DSO. The information needed for remote monitoring and the setting of configurable parameters are specific to each distribution network and to the way it is operated. Signal transmission times between the DSO and/or the TSO control centre and the generating plant will depend on the means of transmission used between the DSO and/or TSO control centre and the generating plant. Informative Annex B of EN50549-2 can be used as guidance regarding the monitoring information and the remote operation parameter setting.</p>		N/A

EN 50549-1:2019			
Clause	Requirement - Test	Result - Remark	Verdict
4.13	<p>Requirements regarding single fault tolerance of interface protection system and interface switch</p> <p>If required in 4.3.2, the interface protection system and the interface switch shall meet the requirements of single fault tolerance.</p> <p>A single fault shall not lead to a loss of the safety functions. Faults of common cause shall be taken into account if the probability for the occurrence of such a fault is significant. Whenever reasonably practical, the individual fault shall be displayed and lead to the disconnection of the power generating unit or system.</p> <p>Series-connected switches shall each have a independent breaking capacity corresponding to the rated current of the generating unit and corresponding to the short circuit contribution of the generating unit.</p> <p>The short-time withstand current of the switching devices shall be coordinated with maximum short circuit power at the connection point.</p> <p>At least one of the switches shall be a switch-disconnector suitable for overvoltage category 2. For single-phase generating units, the switch shall have one contact of this overvoltage category for both the neutral conductor and the line conductor. For poly-phase generating units, it is required to have one contact of this overvoltage category for all active conductors. The second switch may be formed of electronic switching components from an inverter bridge or another circuit provided that the electronic switching components can be switched off by control signals and that it is ensured that a failure is detected and leads to prevention of the operation at the latest at the next reconnection.</p> <p>For PV-inverters without simple separation between the network and the PV generating unit (e.g. PV Inverter without transformer) both switches mentioned in the paragraph above shall be switchdisconnectors with the requirements described therein, although one switching device is permitted to be located between PV array and PV inverter.</p>	(See appended table 4.13)	P
Annex A	Interconnection guidance		Info
Annex B	Void		Info
Annex C	Parameter Table		Info
Annex D	List of national requirements applicable for generating plants		Info
Annex E	Loss of Mains and overall power system security		Info
Annex F	Examples of protection strategies		Info
Annex G	Abbreviations		Info

EN 50549-1:2019			
Clause	Requirement - Test	Result - Remark	Verdict
Annex H	Relationship between this European standard and the COMMISSION REGULATION (EU) 2016/631		Info

Appended Table - Testing Result

4.4.2		Table: Operating frequency range				P
		Frequency Range	Time period for operation Minimum requirement	Time period for operation Most stringent requirement		
		47,0 Hz – 47,5 Hz	not required	20 s		
		47,5 Hz – 48,5 Hz	30 min ^a	90 min		
		48,5 Hz – 49,0 Hz	30 min ^a	90 min ^a		
		49,0 Hz – 51,0 Hz	Unlimited	Unlimited		
		51,0 Hz – 51,5 Hz	30 min ^a	90 min		
		51,5 Hz – 52,0 Hz	not required	15 min		
^a Respecting the legal framework, it is possible that longer time periods are required by the relevant authority in some synchronous areas.						
Steps	f (Hz)	f (Hz) Measured	Time	Time measured	Comments	
1	47 Hz	47.0	>20 s	123s		
2	47.5 Hz	47.5	>90 min	104min	severe conditions: >90 min	
3	48.5 Hz	48.5	>90 min	111min	severe conditions: >90 min	
4	52 Hz	52.0	>15 min	34min		
5	50 Hz	50.0	> 1 min	182s		
6	51.5 Hz	51.5	>90 min	112min	severe conditions: >90 min	

4.4.3 Table: Minimal requirements for active power delivery at underfrequency P

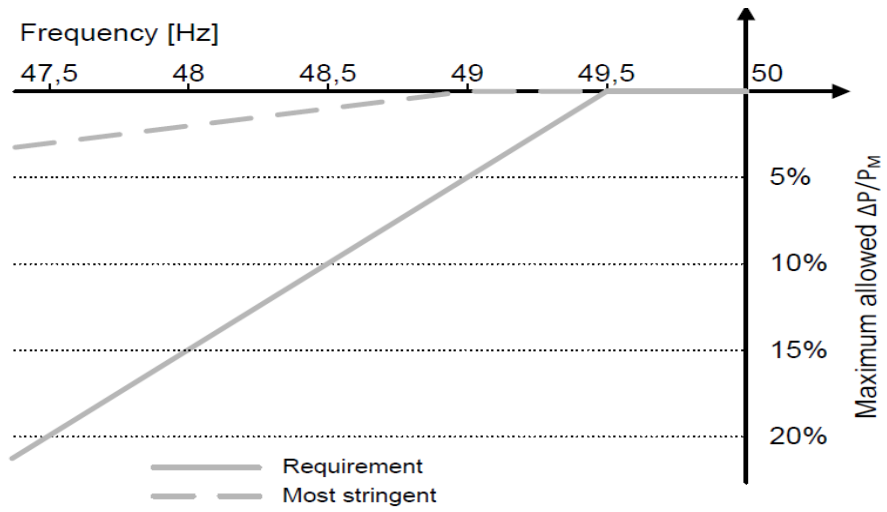
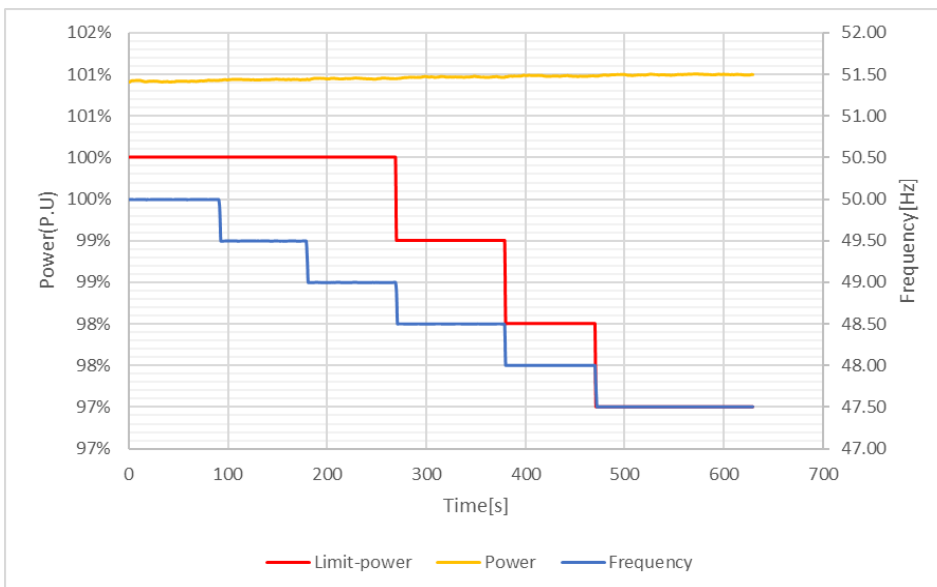

Figure 5 — Maximum allowable power reduction in case of underfrequency

Step	f (Hz)	fmea. (Hz)	T (s)	T meas. (s)	P (%) - max	P (%) - min	P meas. (%)
1	50,00 ± 0,05	50.0	>60	90	100%	100%	100.92
2	49.50 ± 0,05	49.5	>60	90	100%	100%	100.94
3	49.00 ± 0,05	49.0	>60	90	100%	100%	100.95
4	48.50 ± 0,05	48.5	>60	90	100%	99%	100.97
5	48.00 ± 0,05	48.0	>60	90	100%	98%	100.99
6	47.50 ± 0,05	47.5	>60	90	100%	97%	100.00

Supplementary information:



4.4.4		Table: Continuous voltage operation range			P
Step	Voltage (%)	P (%)	P meas. (%)	Time (s)	T meas (s)
1	100	100	100.93	>60	120.00
2	85	100 (*)	95.61	>120	219.00
3	100	100	100.92	>5	58.00
4	110	100	100.65	>120	214.00

(*) Active power reduction is allowed due to current limitation.

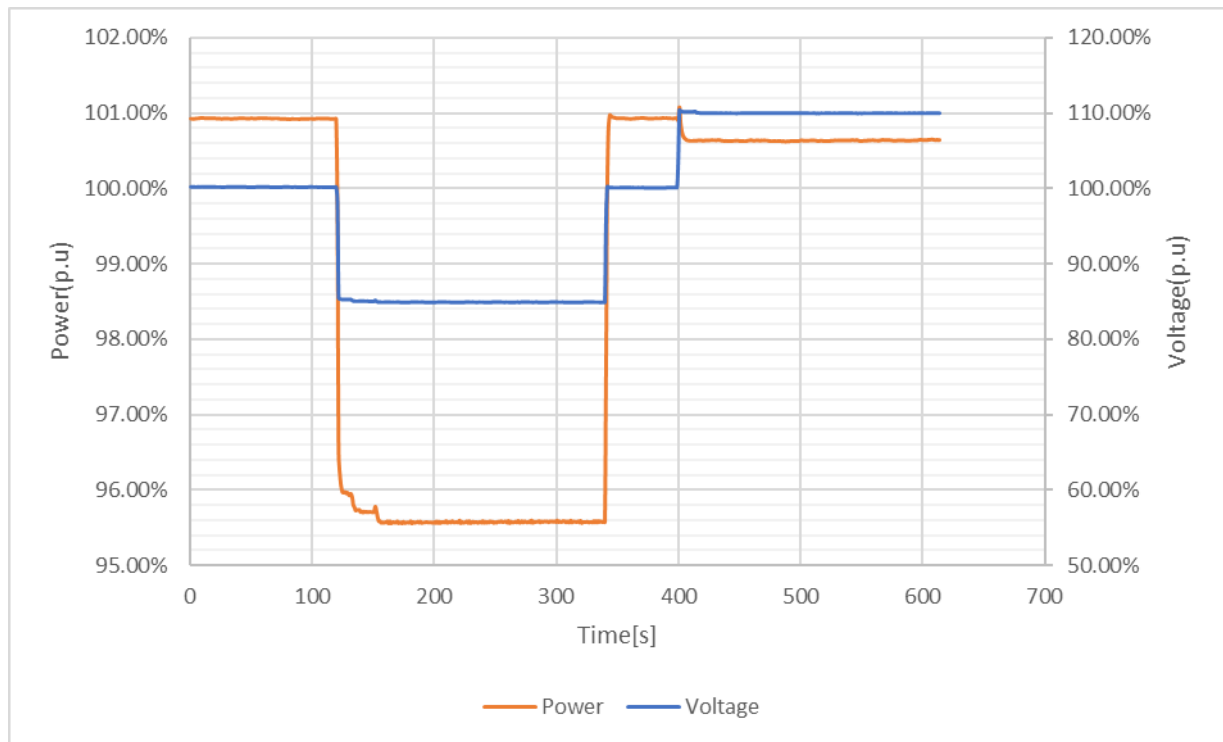

4.5.2 Rate of change of frequency (ROCOF)					P
Steps	f (Hz)	Δt (s) step change	Stop time	f meas. (Hz)	t meas. (s)
1	50.00 ± 0,05	n/a	>10 s	50.0	63.2
2	52.00 ± 0,05	1 s	>10 s	50.0 to 52.0	1.0
3	50.00 ± 0,05	1 s	>10 s	52.0 to 50.0	1.0
4	48.00 ± 0,05	1 s	>10 s	50.0 to 48.0	1.0
5	50.00 ± 0,05	1 s	>10 s	48.0 to 50.0	1.0

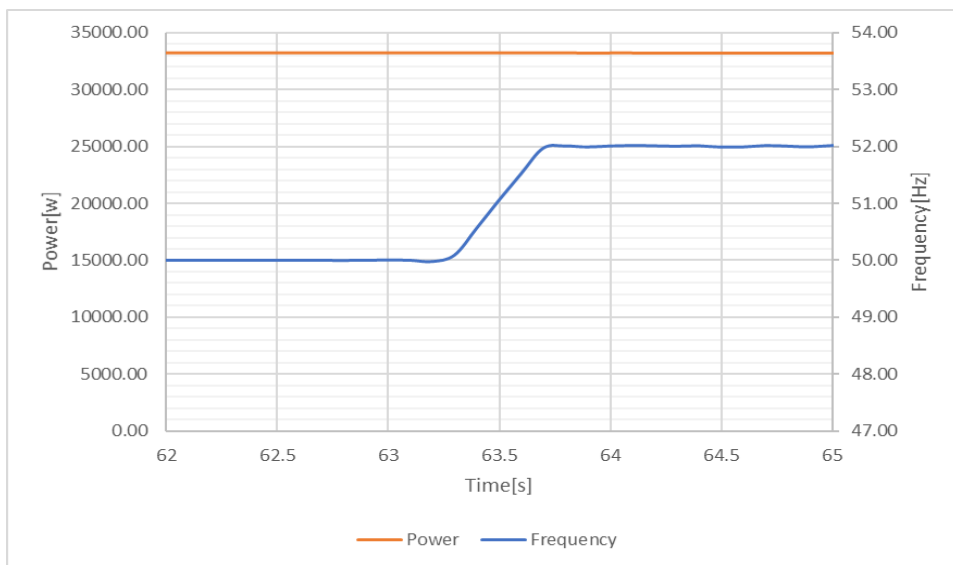
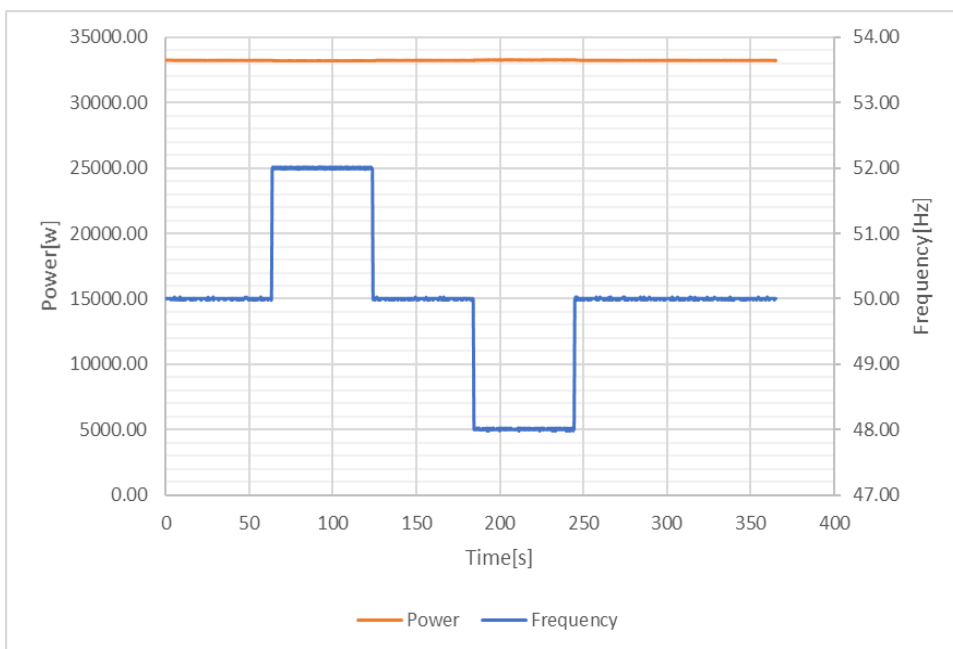

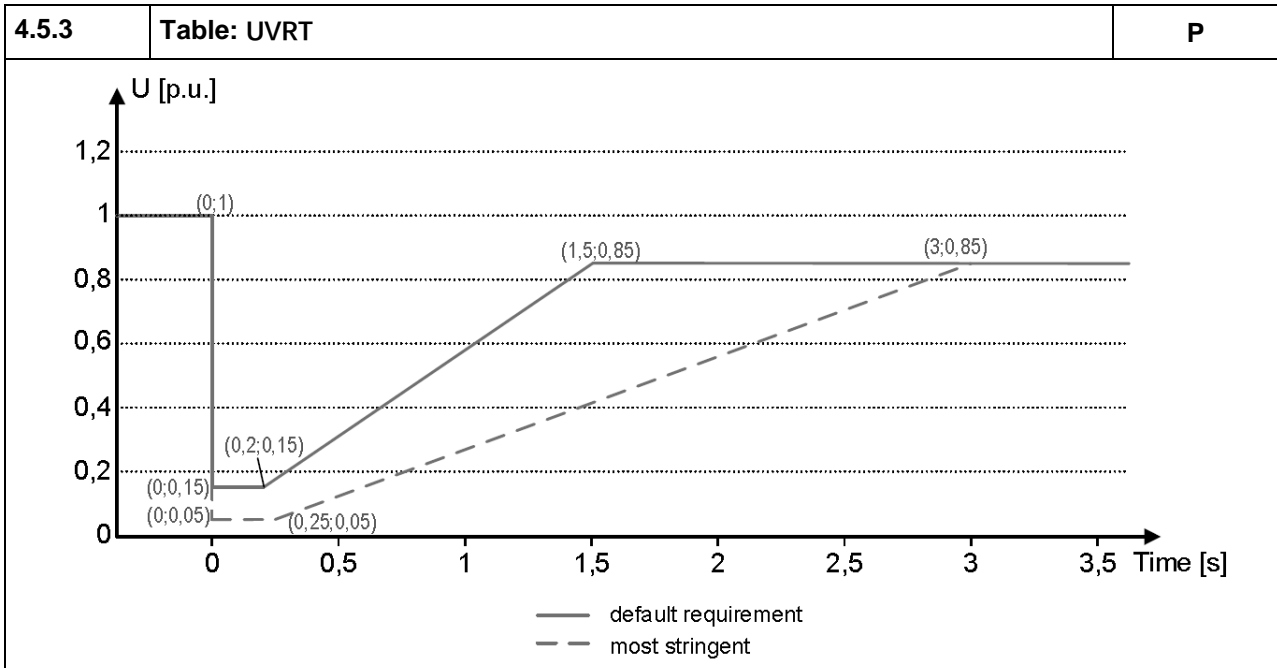

Test at full load (>90%)

Udip	Type	t min (ms)	U meas.(%)			T meas.(ms)	P recover (s)
			R	S	T		
5%	L1-N	250	2.33	100.49	100.39	420	0.11
	L2-N		100.40	2.29	100.50	430	0.11
	L3-N		100.46	100.38	2.34	430	0.13
	L1-L2-N		2.52	2.61	100.73	430	0.19
	L2-L3-N		100.27	2.18	2.17	430	0.21
	L1-L3-N		2.66	100.68	2.54	430	0.19
	L1-L2-L3-N		2.77	2.80	2.83	430	0.17
25%	L1-N	938	24.79	100.26	100.24	1030	0.51
	L2-N		100.21	24.79	100.24	1030	0.53
	L3-N		100.20	100.22	24.78	1010	0.47
	L1-L2-N		25.04	25.02	100.25	1030	0.19
	L2-L3-N		100.29	25.04	25.03	1030	0.57
	L1-L3-N		25.03	100.26	25.04	1030	0.57
	L1-L2-L3-N		25.07	25.07	25.10	1030	0.23

50%	L1-N	1797	50.04	100.21	100.19	1990	0.45
	L2-N		100.22	50.06	100.19	1990	0.55
	L3-N		100.25	100.21	50.04	1990	0.39
	L1-L2-N		50.07	50.07	100.22	1990	0.55
	L2-L3-N		100.25	50.07	50.07	1990	0.53
	L1-L3-N		50.1	100.23	50.08	1990	0.55
	L1-L2-L3-N		50.10	50.10	50.11	1990	0.21
75%	L1-N	2656	75.66	100.06	100.11	3040	0.3
	L2-N		100.22	74.98	100.26	3030	0.31
	L3-N		100.25	100.21	74.98	3030	0.31
	L1-L2-N		75.03	74.99	100.27	3030	0.71
	L2-L3-N		100.26	75.01	75.05	3030	0.72
	L1-L3-N		75.04	100.18	75.04	3030	0.42
	L1-L2-L3-N		75.05	75.04	75.04	3030	0.23
Remark:							
The tests are performed together with clause 4.7.4.2.2 Zero current mode and enabling of default setting: undervoltage of 50%Un							

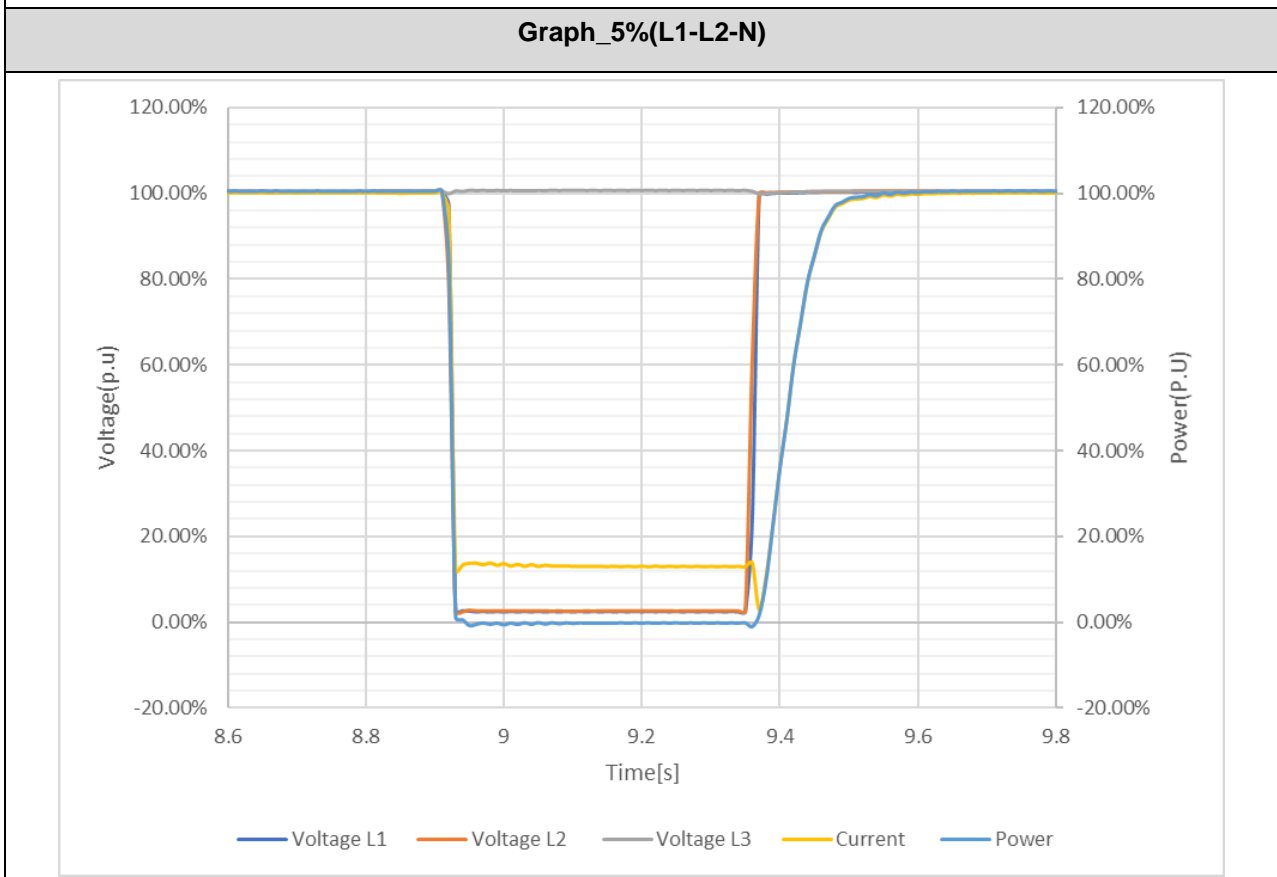
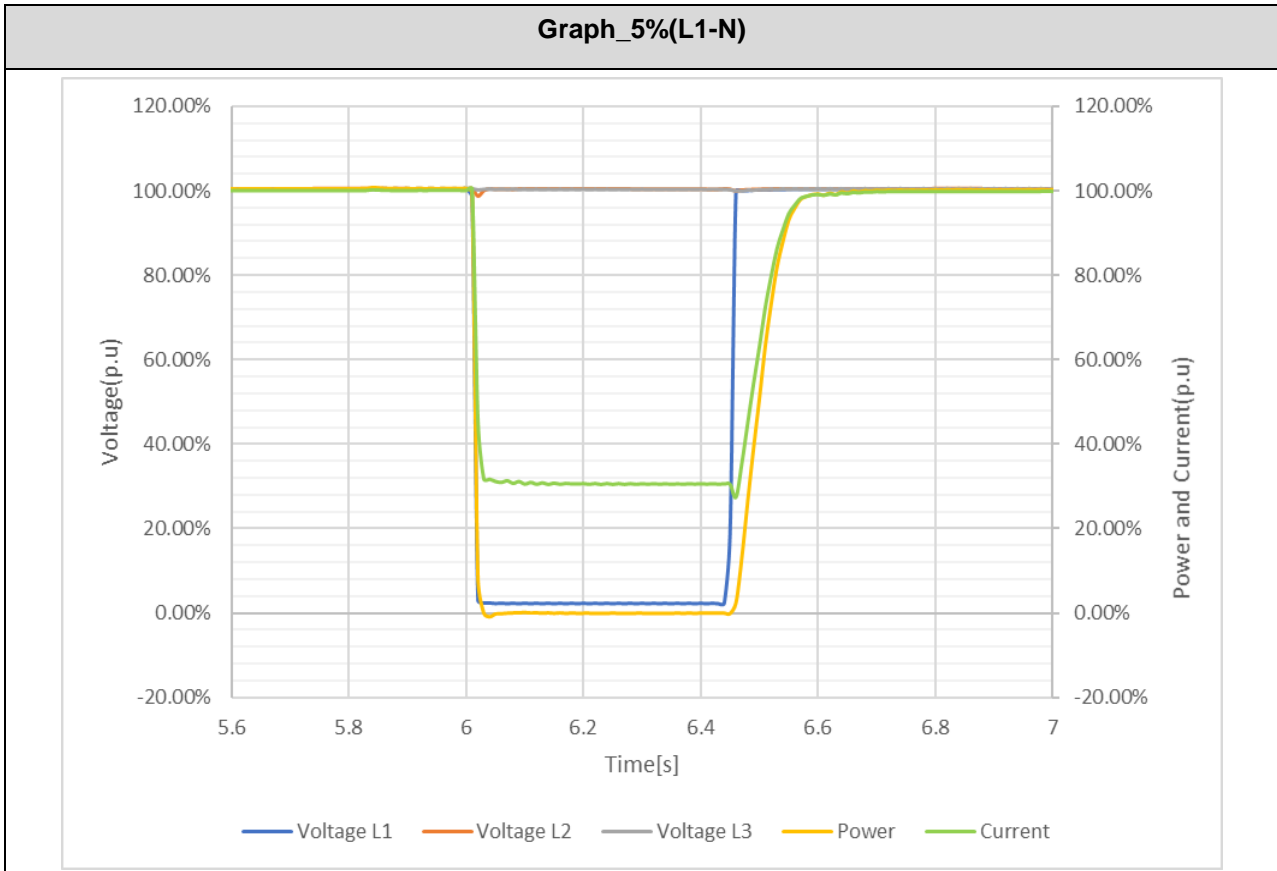

Graph_5%(L1-L2-L3-N)

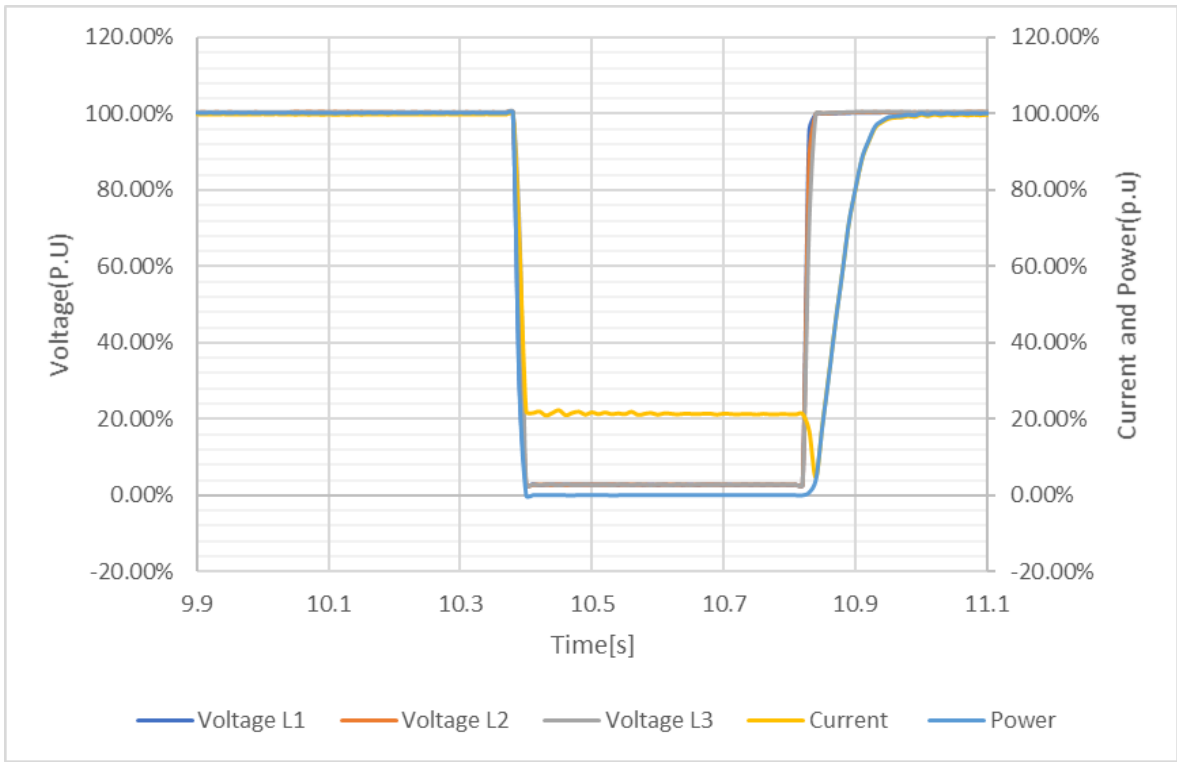

Graph_25%(L1-N)

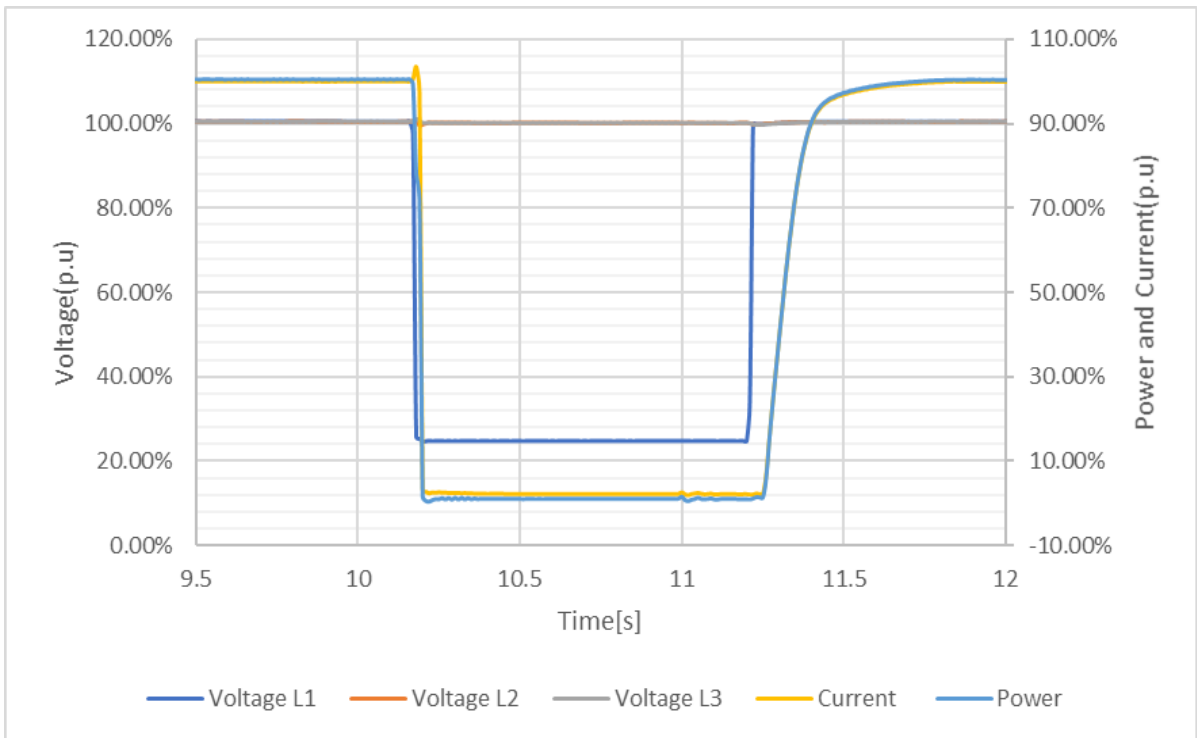

Graph_25%(L1-L2-N)

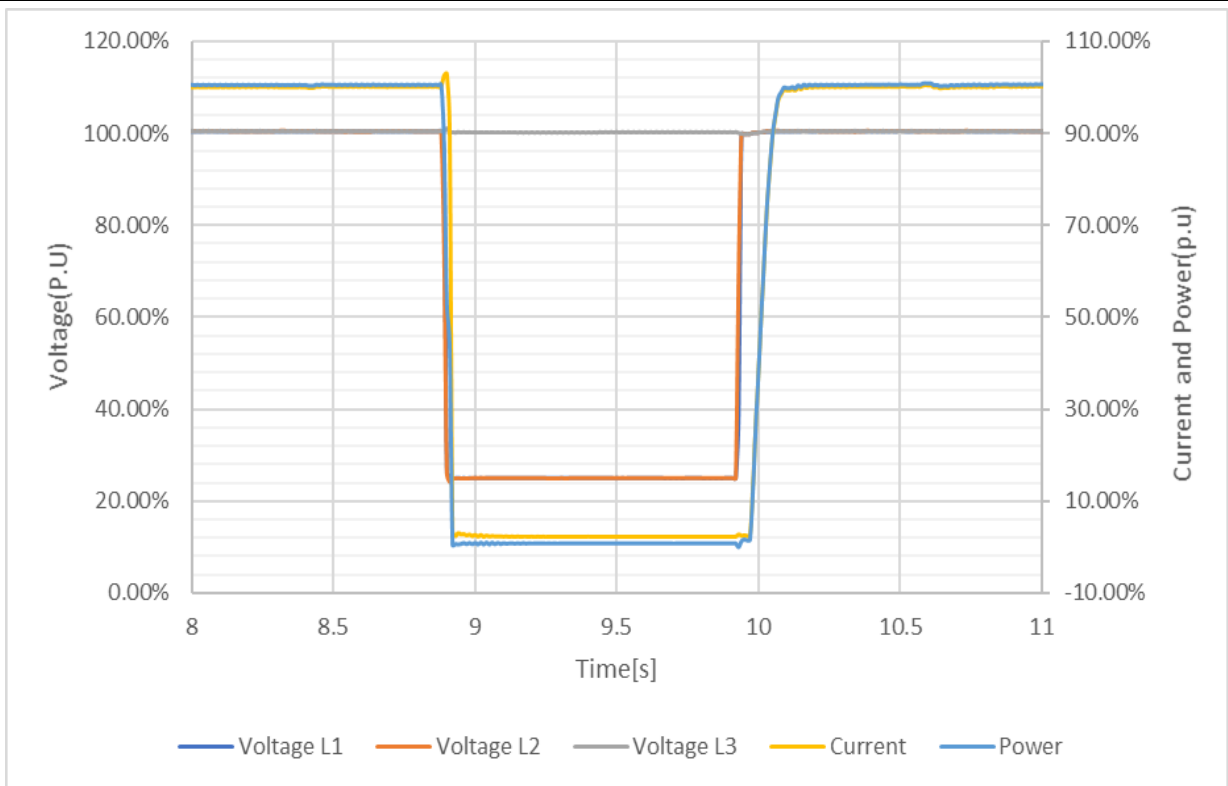

Graph_25%(L1-L2-L3-N)

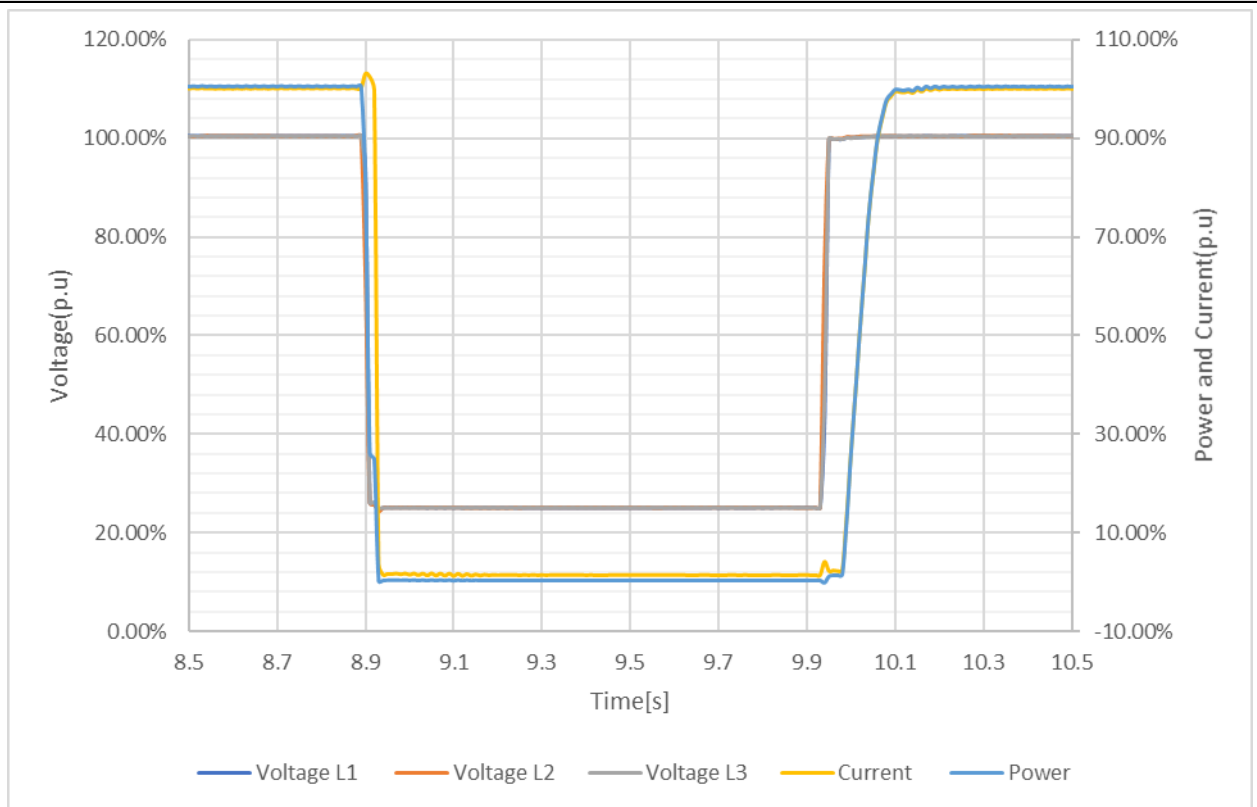

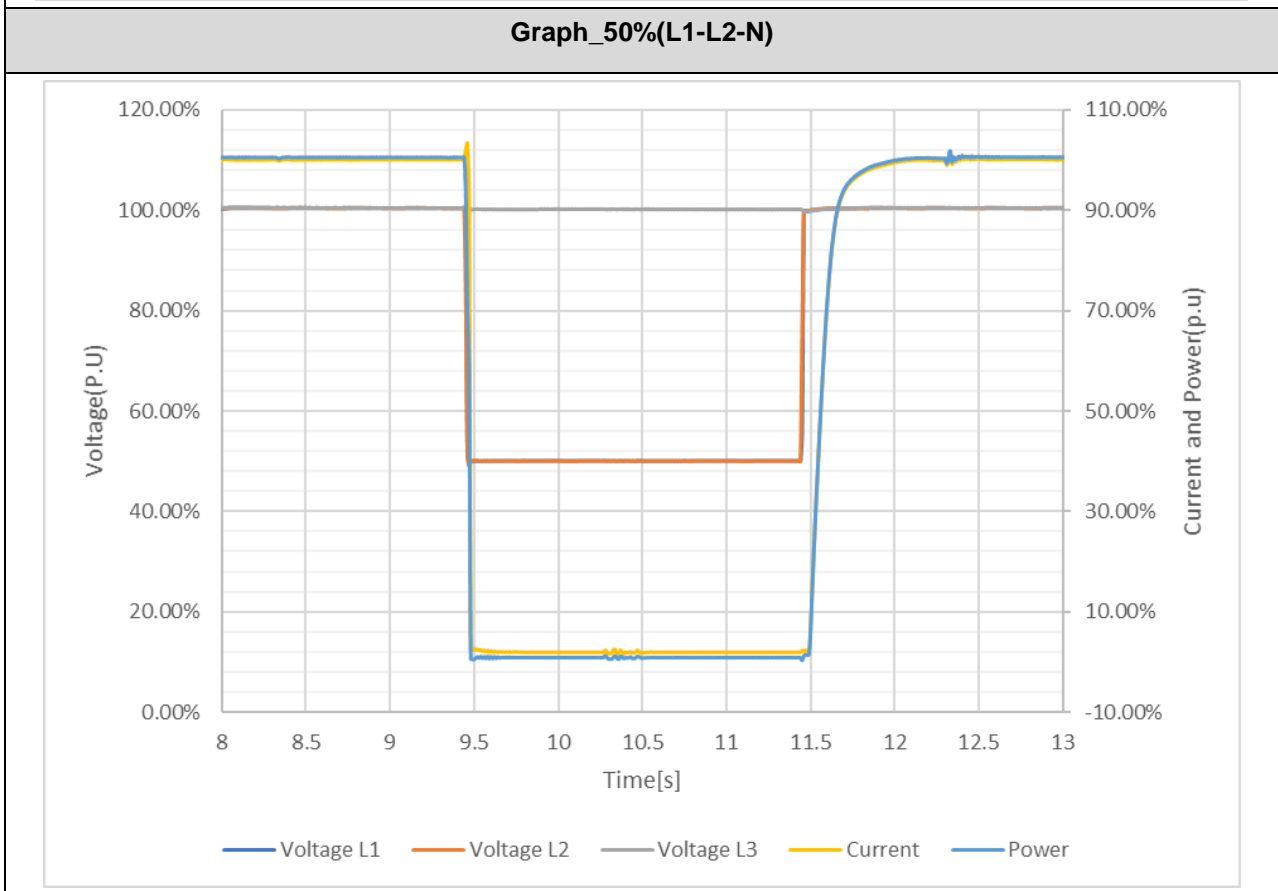
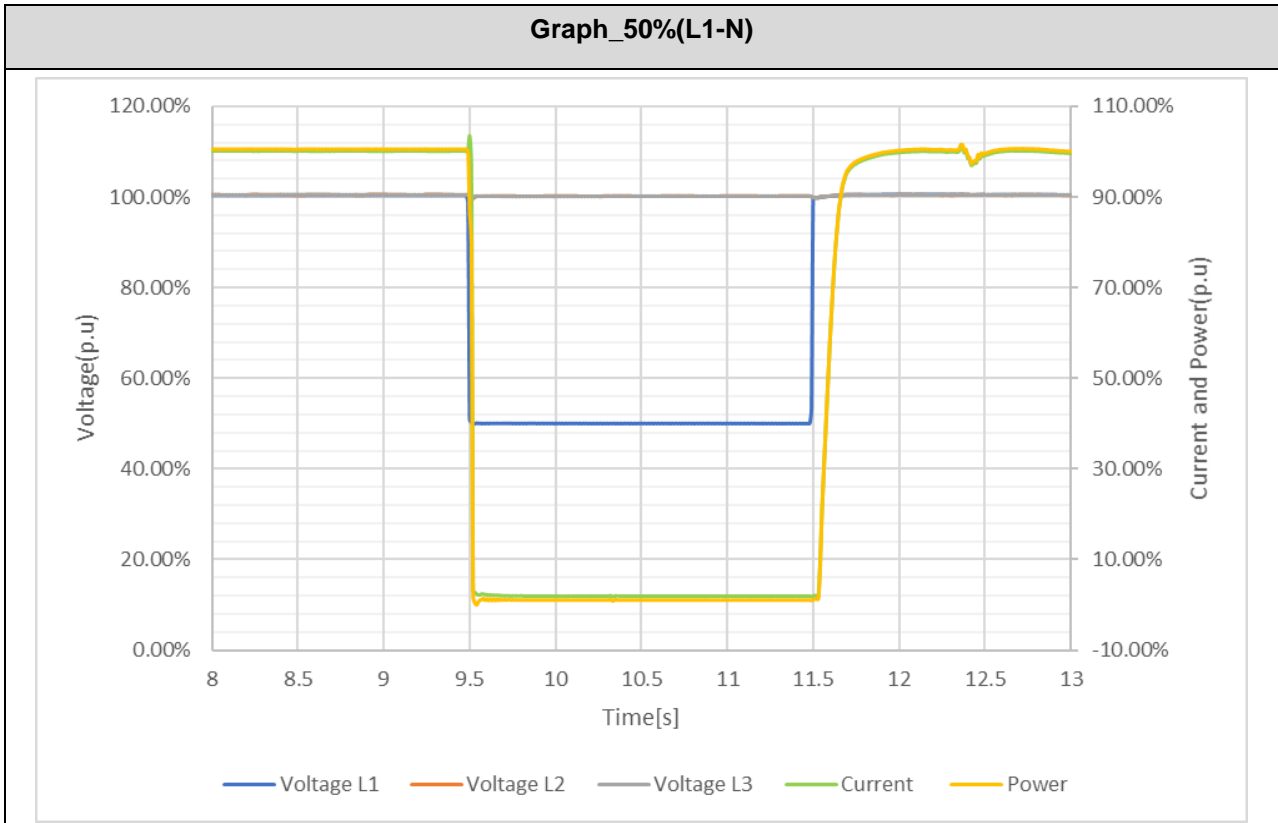

Graph_50%(L1-L2-L3-N)

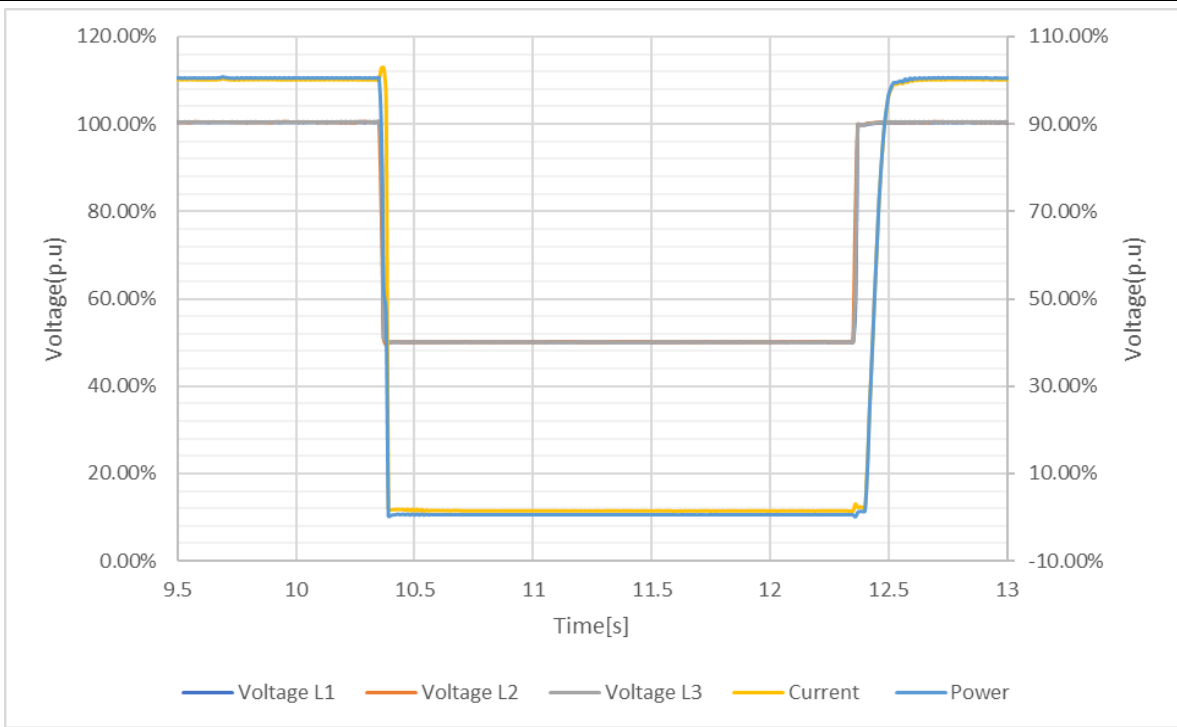

Graph_75%(L1-N)

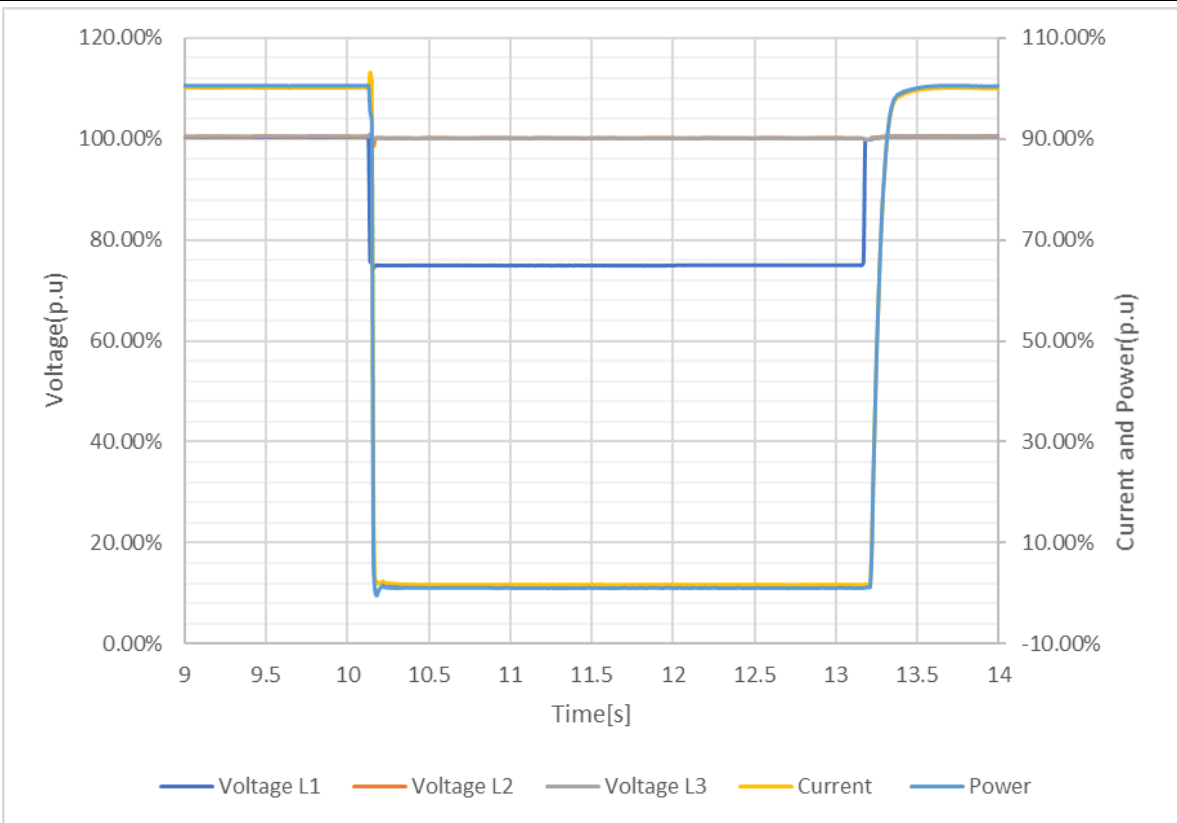

Graph_75%(L1-L2-N)

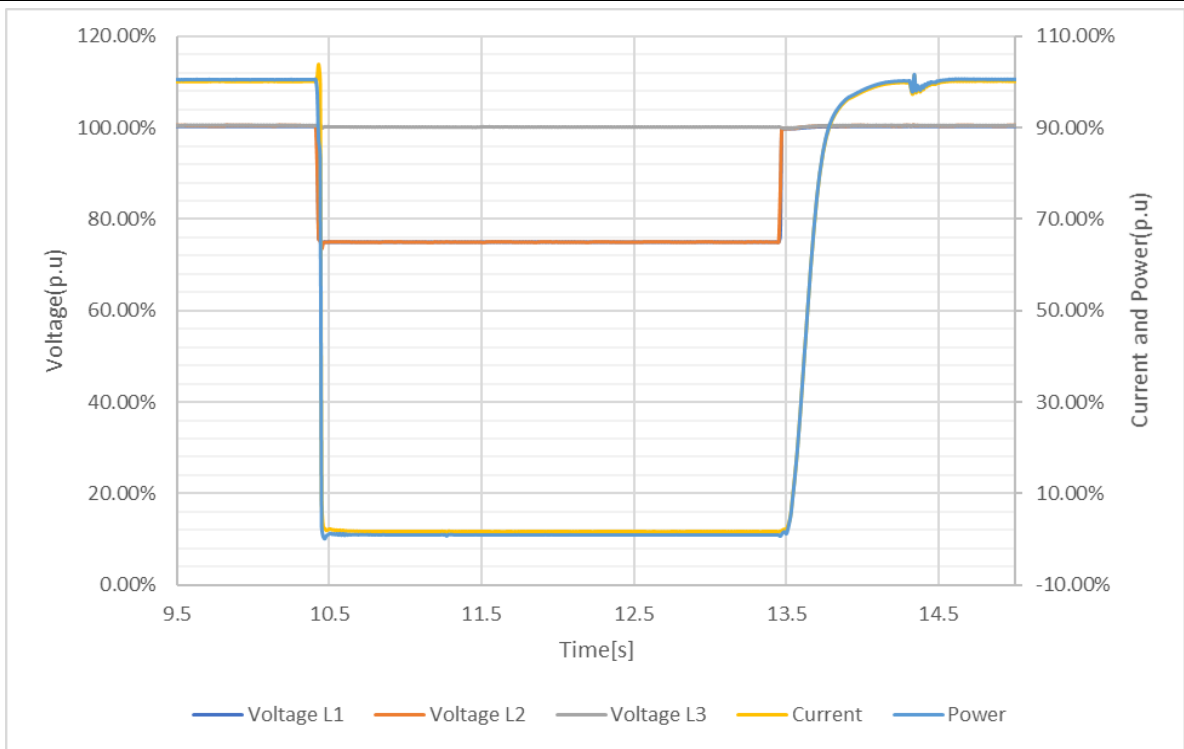

Graph_75%(L1-L2-L3-N)

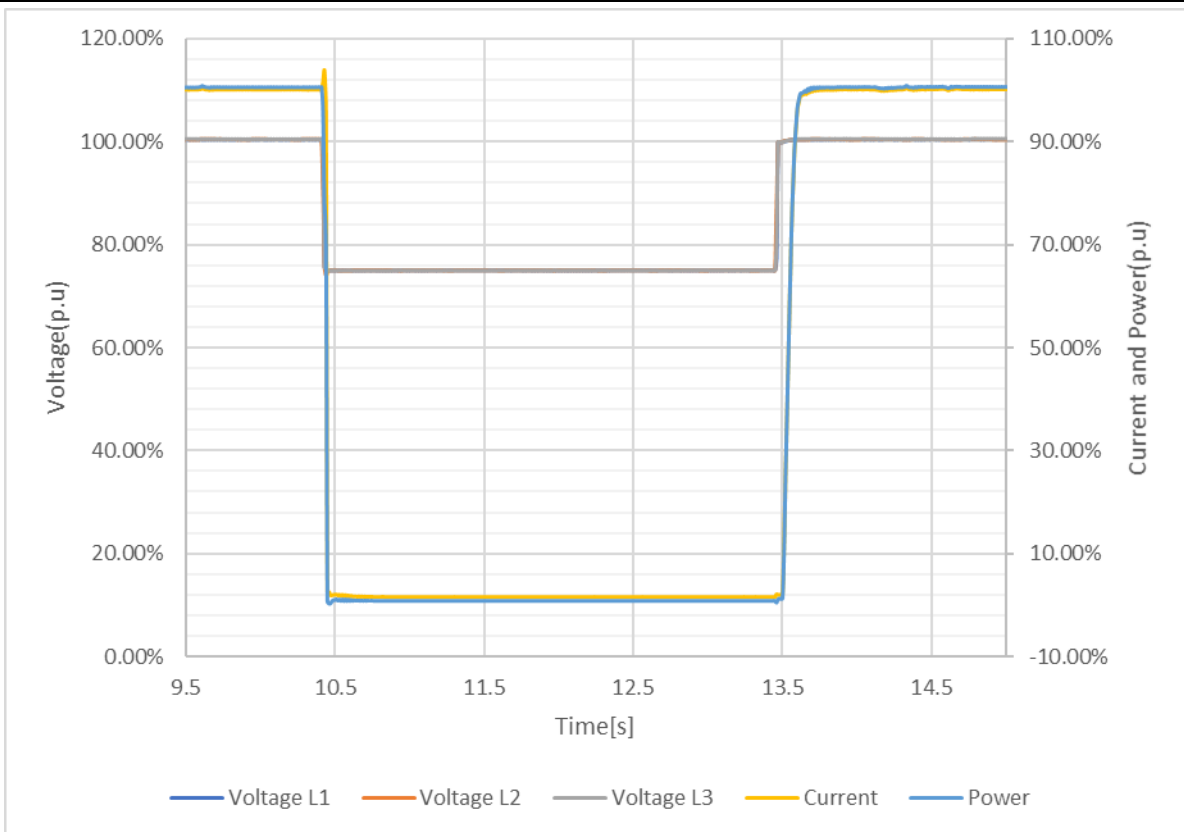

Test at partial load (20%)							
Udip	Type	t min (ms)	U meas.(%)			T meas.(ms)	P recover (s)
			R	S	T		
5%	L1-N	250	2.08	100.18	100.18	450	0.02
	L2-N		100.17	2.14	100.16	450	0.03
	L3-N		100.19	100.23	2.15	450	0.05
	L1-L2-N		2.21	2.15	100.30	450	0.04
	L2-L3-N		100.30	2.18	2.17	450	0.04
	L1-L3-N		2.20	100.28	2.21	450	0.04
	L1-L2-L3-N		2.17	2.16	2.18	450	0.03
25%	L1-N	938	24.97	100.15	100.18	1050	0.12
	L2-N		100.19	24.96	100.22	1050	0.11
	L3-N		100.19	100.18	25.01	1050	0.13
	L1-L2-N		25.01	24.98	100.24	1050	0.12
	L2-L3-N		100.16	24.98	24.99	1050	0.11
	L1-L3-N		25.00	100.20	24.99	1050	0.1
	L1-L2-L3-N		25.00	25.01	25.06	1050	0.16
50%	L1-N	1797	50.04	100.12	100.23	1890	0.10
	L2-N		100.20	50.02	100.19	1890	0.10
	L3-N		100.20	100.15	50.02	1890	0.10
	L1-L2-N		50.04	50.07	100.23	1890	0.12
	L2-L3-N		100.23	50.06	50.04	1890	0.10
	L1-L3-N		50.07	100.23	50.05	1890	0.12
	L1-L2-L3-N		50.05	50.08	50.07	1890	0.14
75%	L1-N	2656	74.91	100.20	100.22	3050	0.12
	L2-N		100.20	74.88	100.20	3050	0.12
	L3-N		100.16	100.17	74.88	3040	0.12
	L1-L2-N		74.91	74.90	100.23	3050	0.12
	L2-L3-N		100.20	74.90	74.91	3050	0.12

	L1-L3-N		74.94	100.17	74.90	3050	0.12
	L1-L2-L3-N		74.93	74.92	74.95	3050	0.12

Remark:

The tests are performed together with clause 4.7.4.2.2 Zero current mode and enabling of default setting: undervoltage of 50%Un

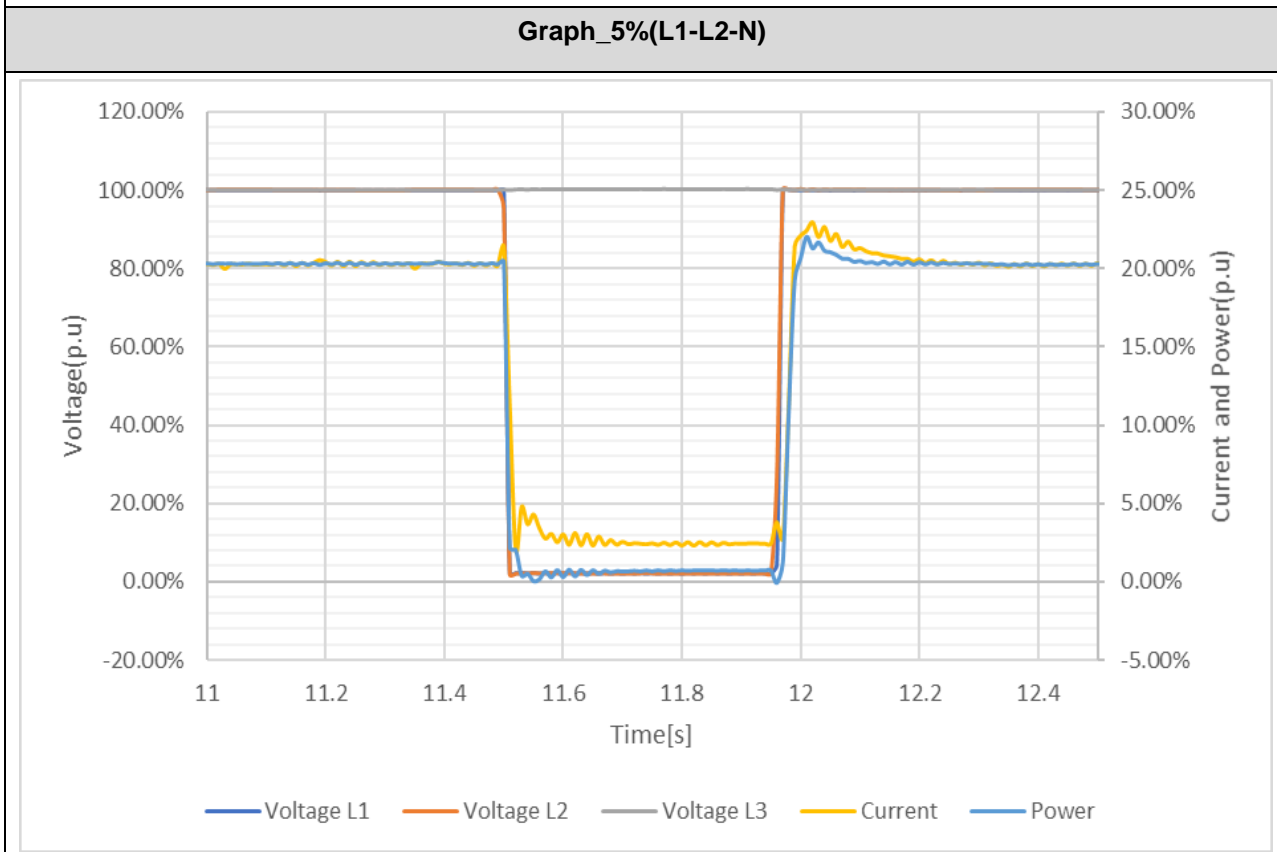
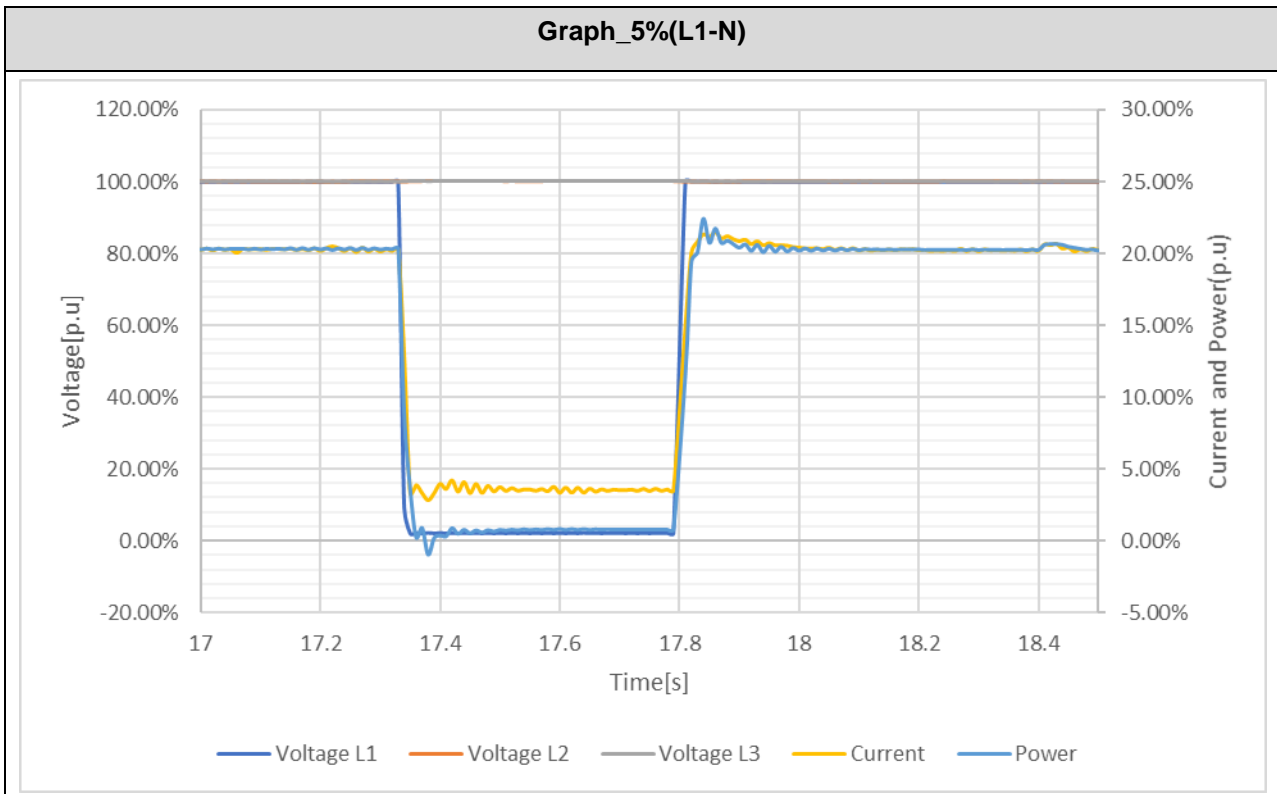

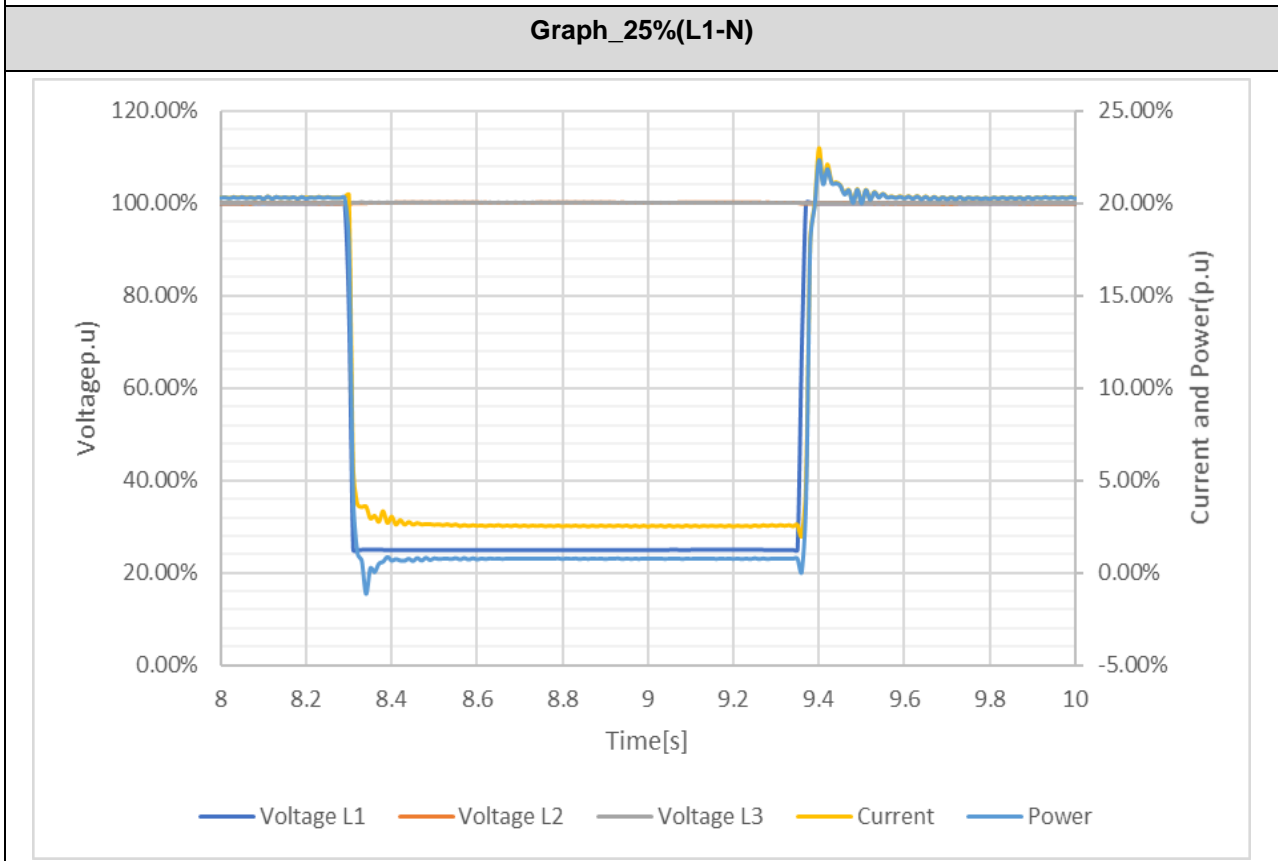
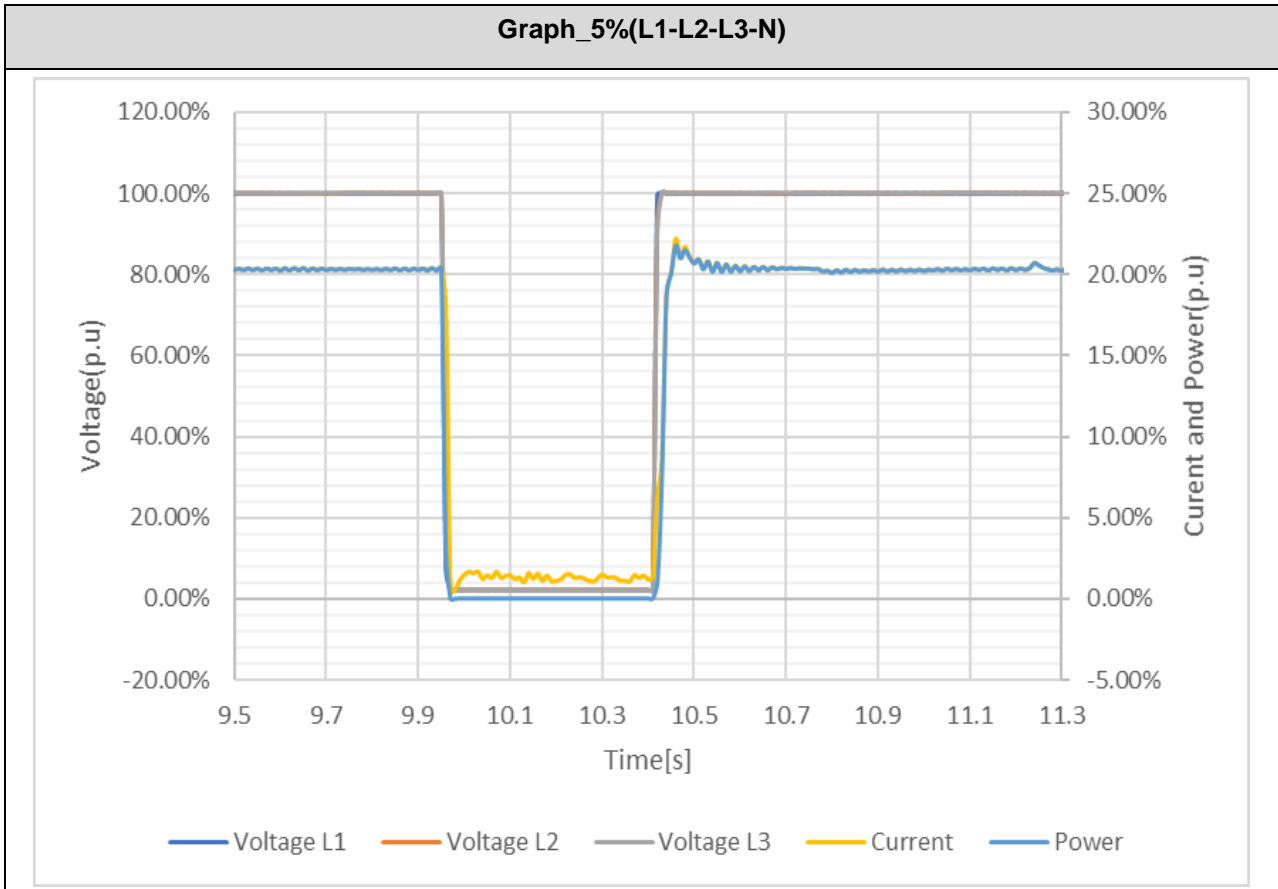

Graph_25%(L1-L2-N)

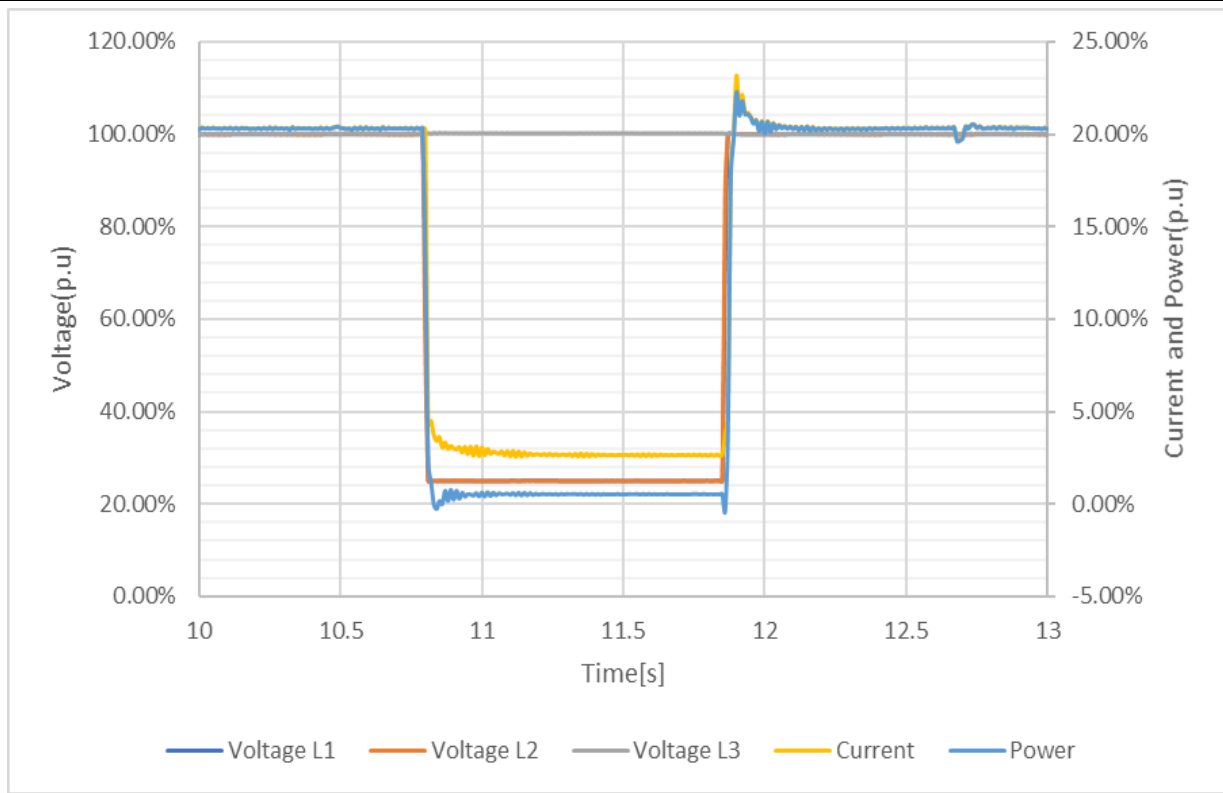

Graph_25%(L1-L2-L3-N)

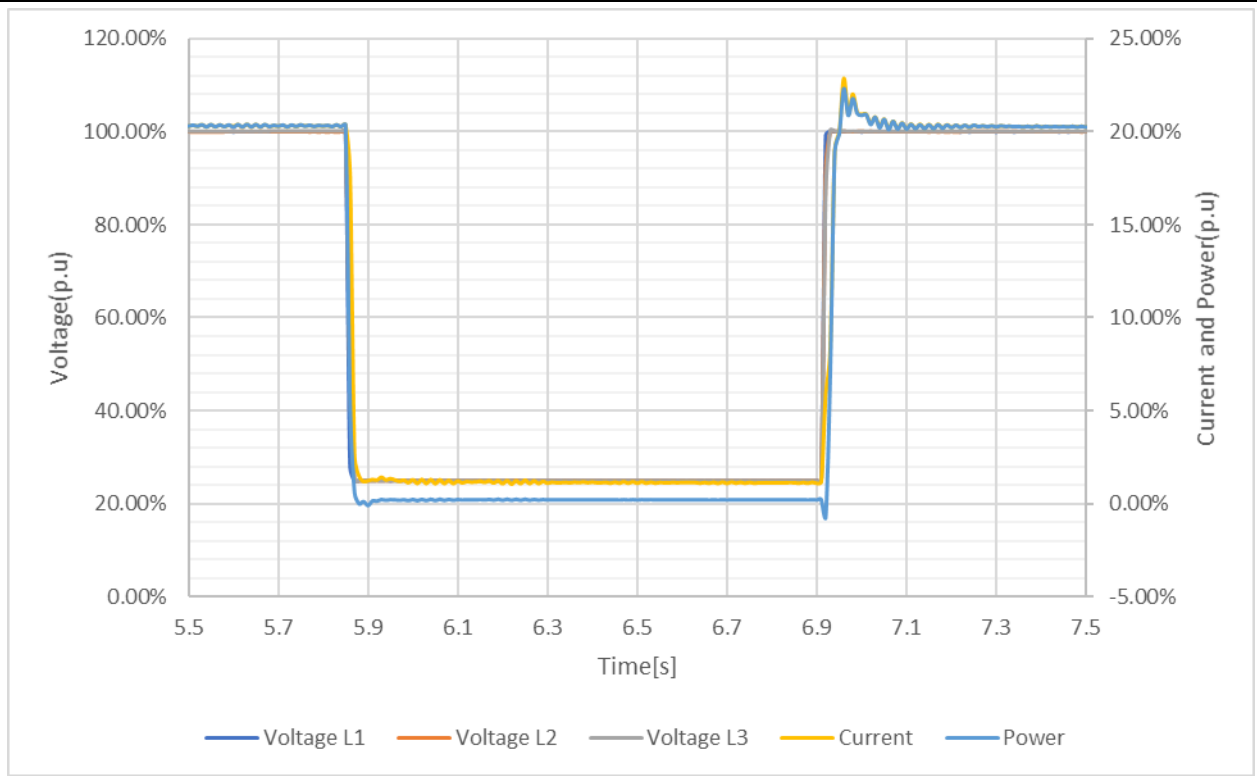

Graph_50%(L1-N)

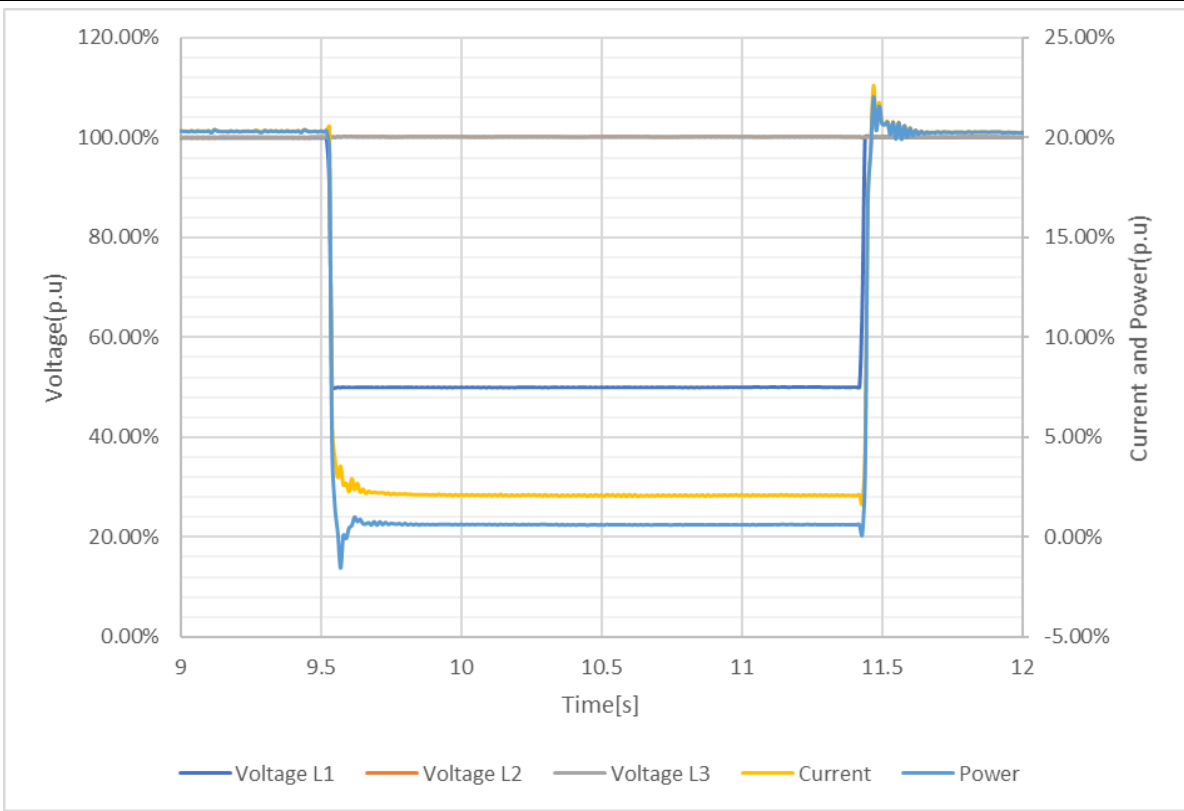

Graph_50%(L1-L2-N)

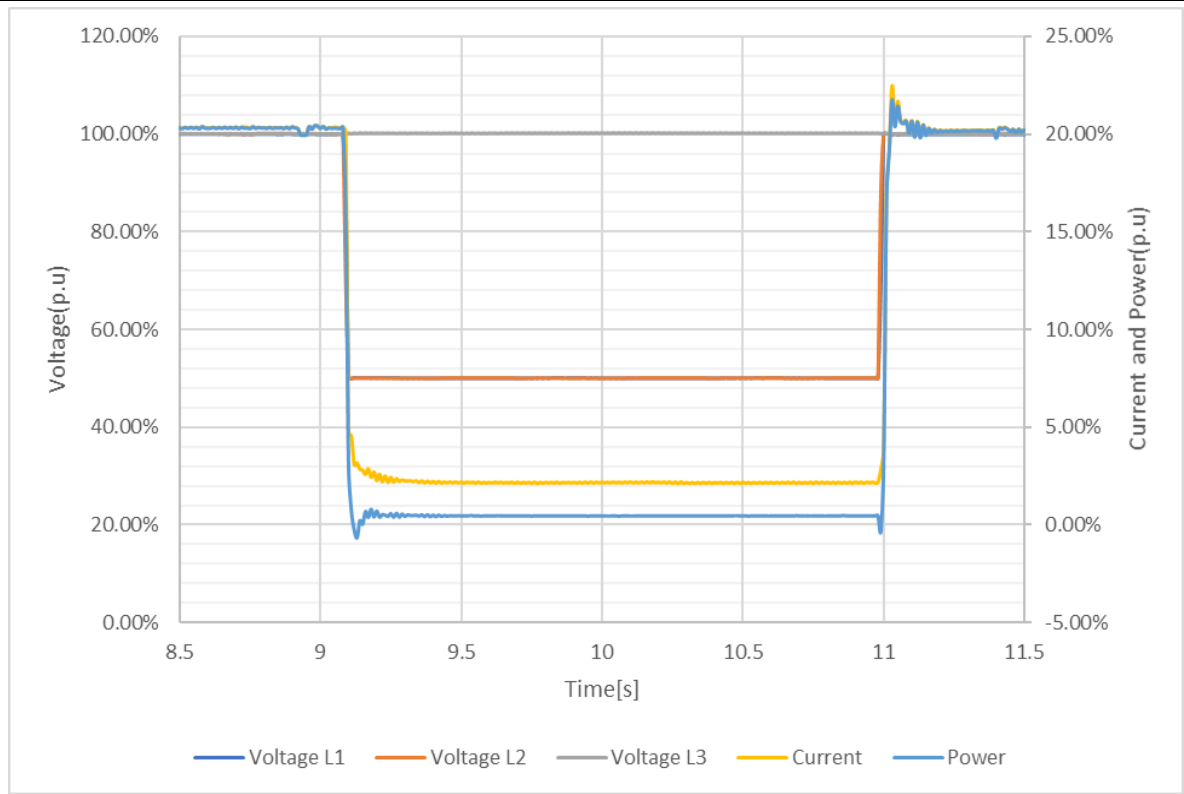

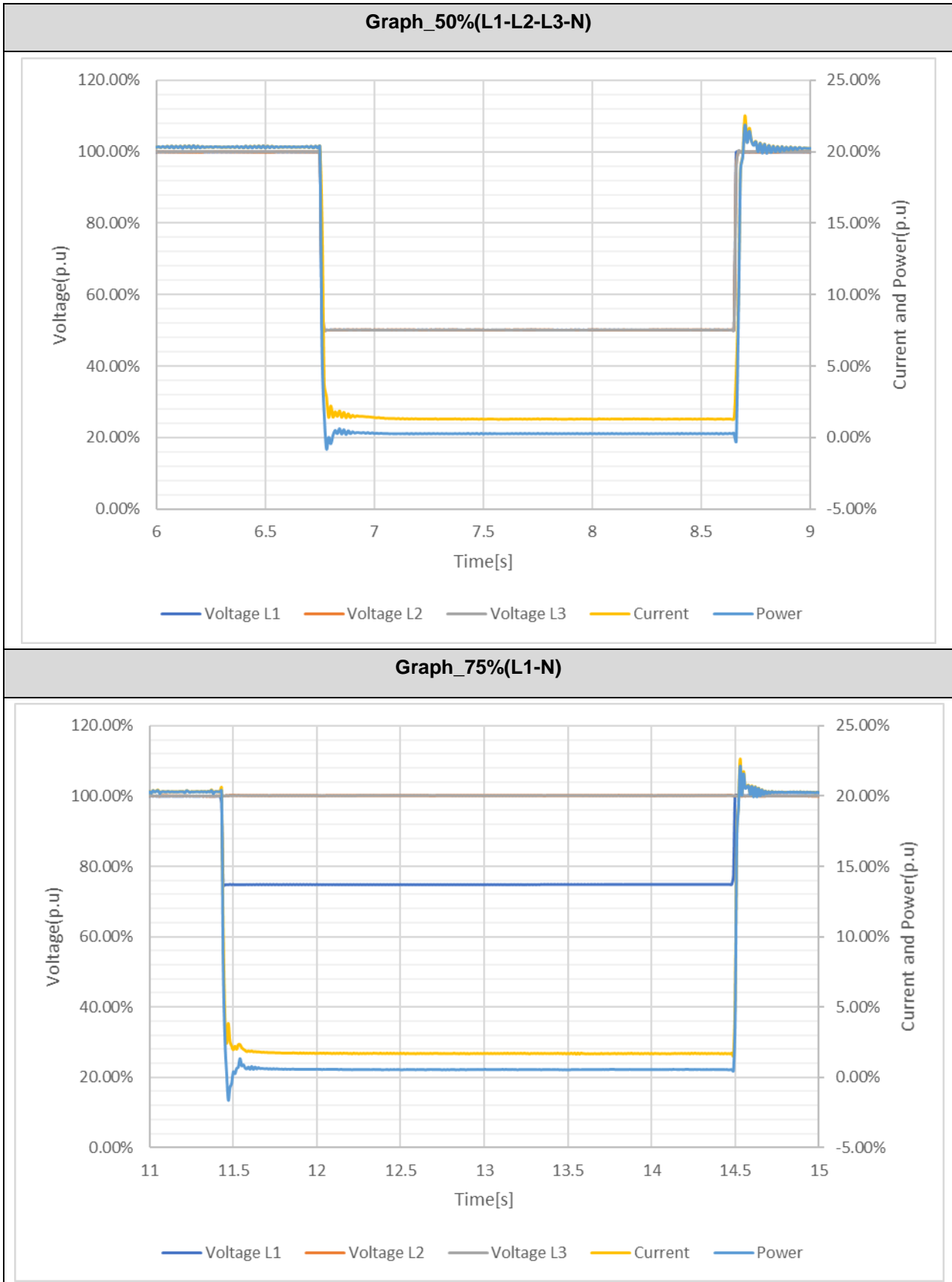

Graph_75%(L1-L2-N)

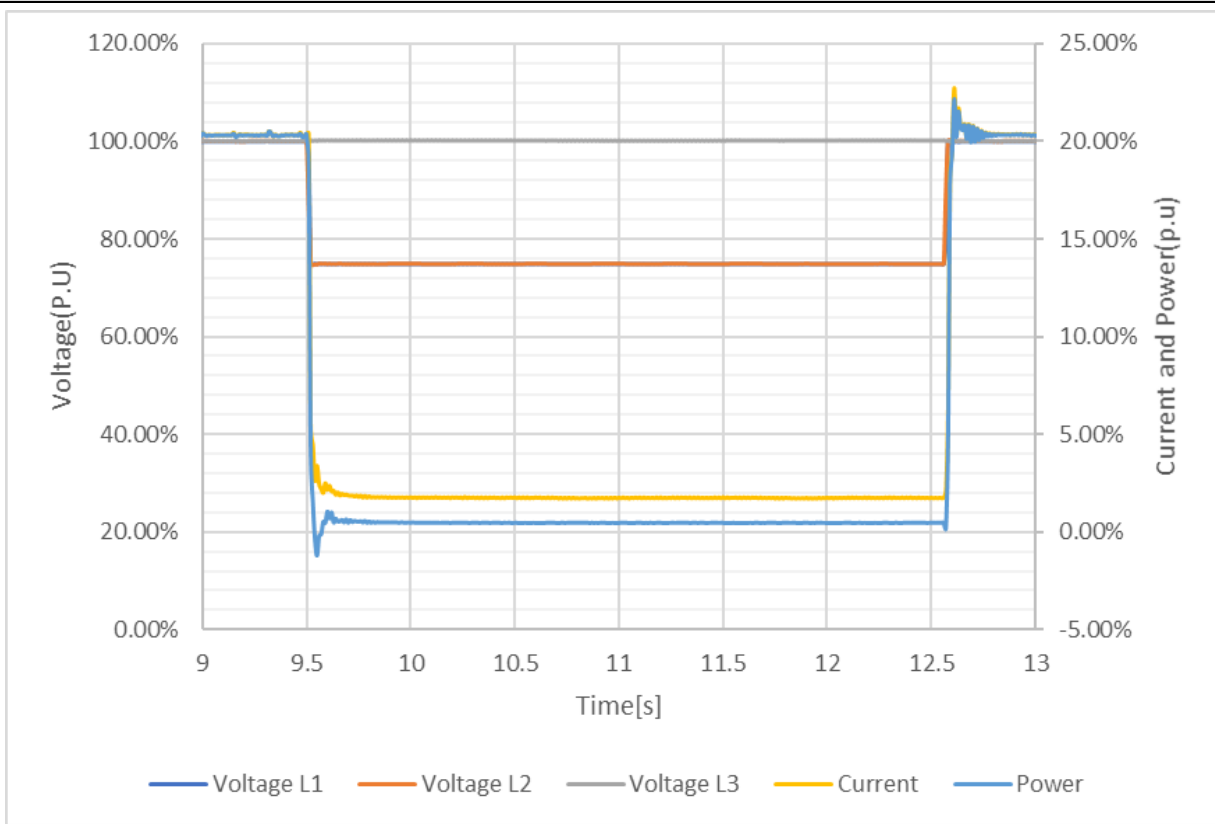

Graph_75%(L1-L2-L3-N)

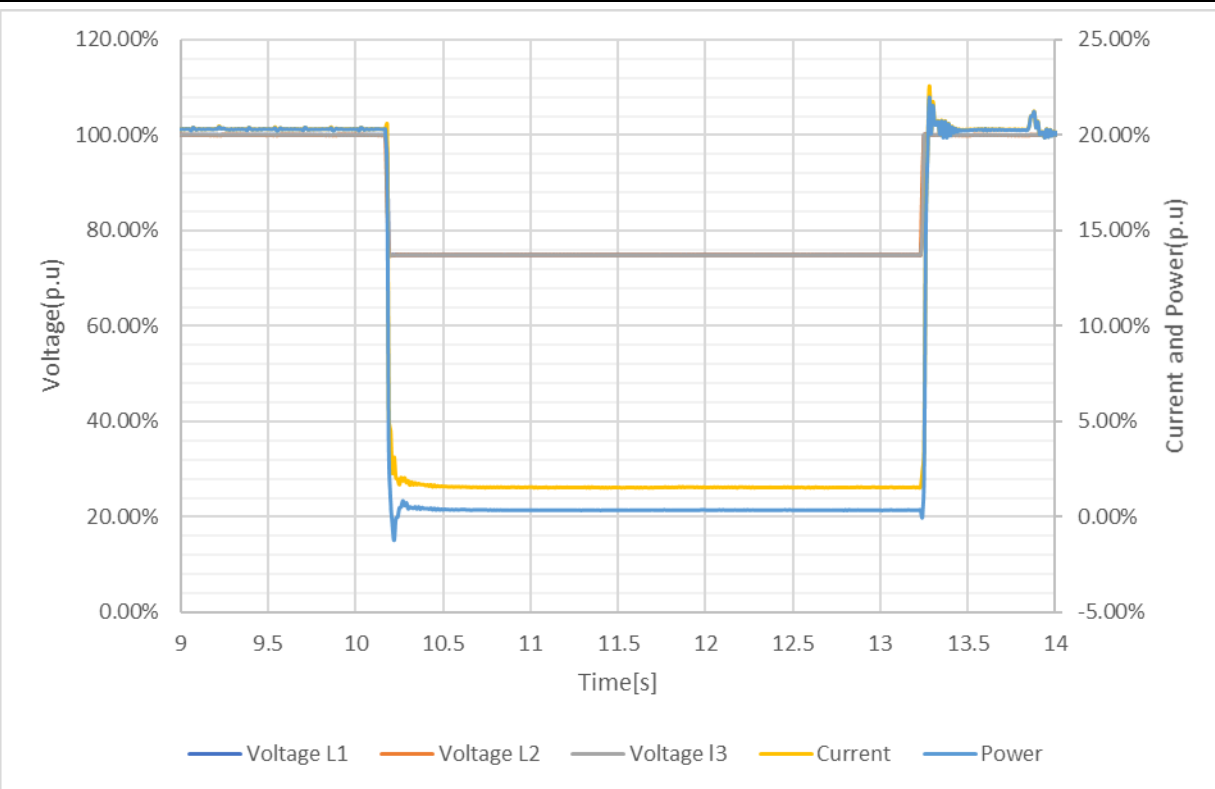

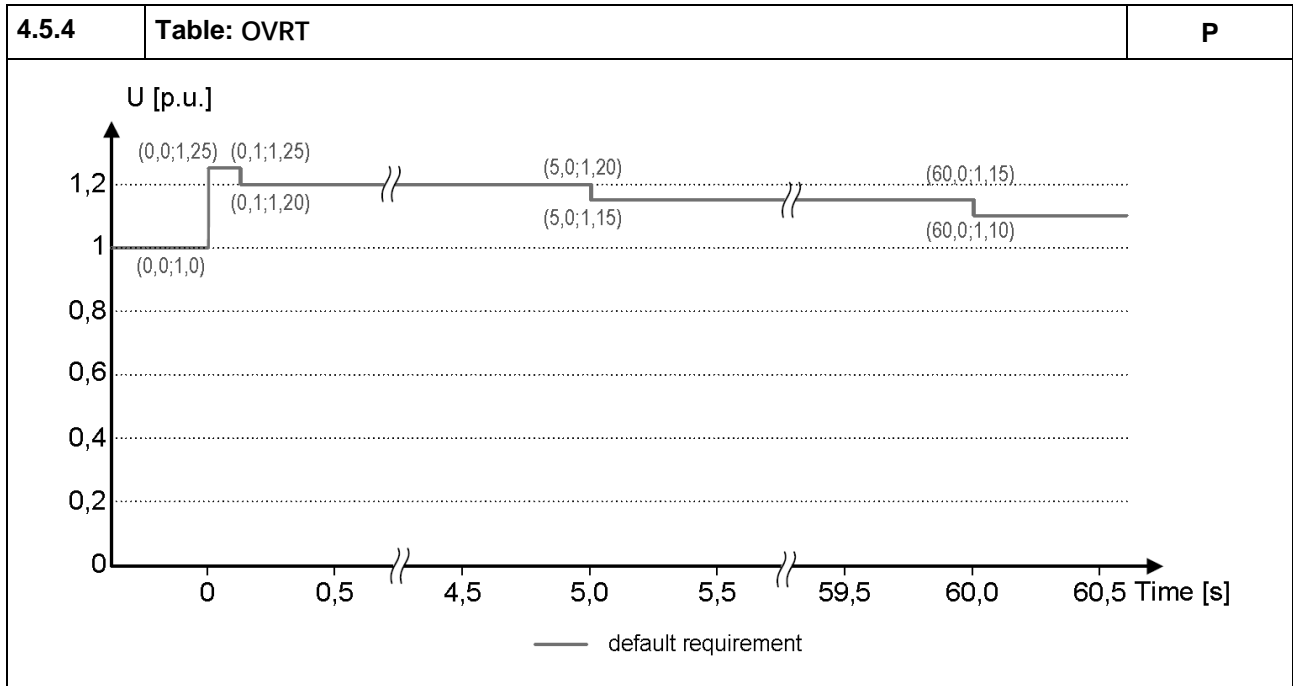

Test at full load (>90%)

Udip	Type	t min (ms)	U meas. (%)			T meas. (ms)	P recover (s)
			R	S	T		
125%	3 ph	100	125.16	125.01	125.15	150	0.12
120%	3 ph	5000	120.14	120.05	120.11	5070	0.13
115%	3 ph	60000	115.10	115.10	115.11	60070	0.09

Remark:

The tests are performed together with clause 4.7.4.2.2 Zero current mode and enabling of default setting: Overvoltage of 120%Un

Graph_125%

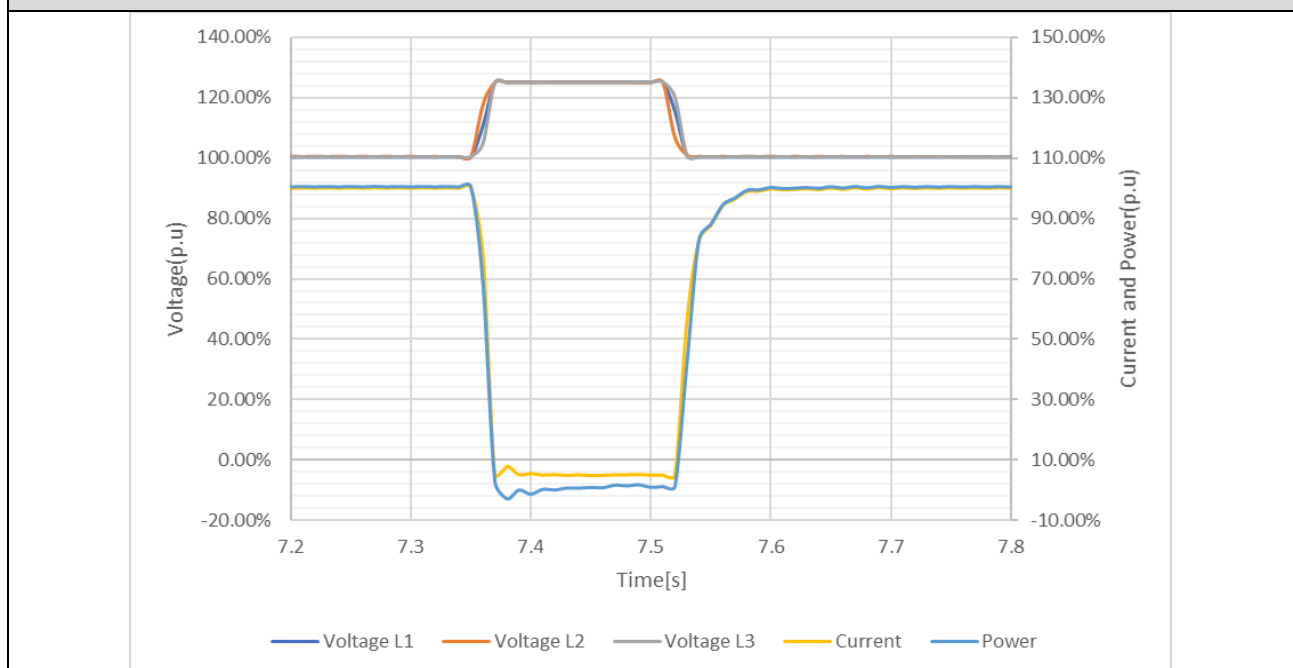

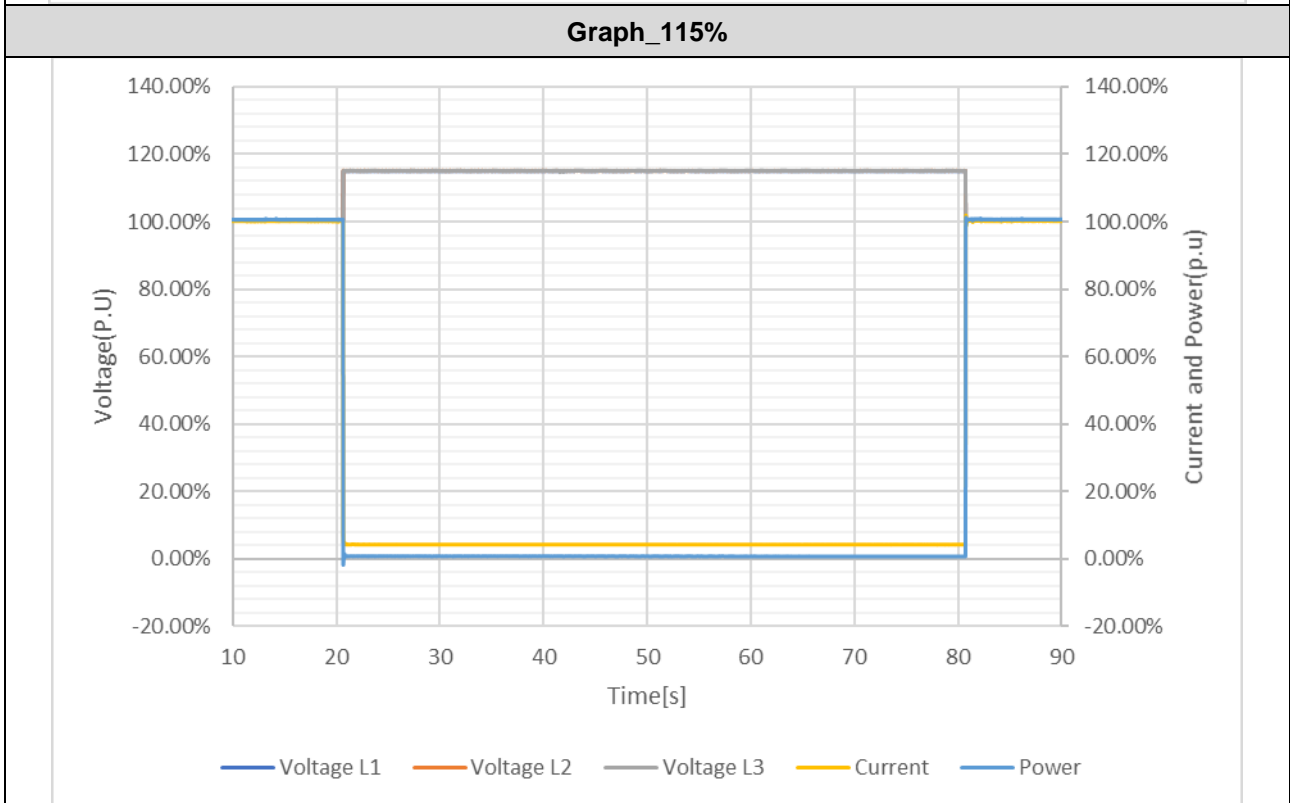
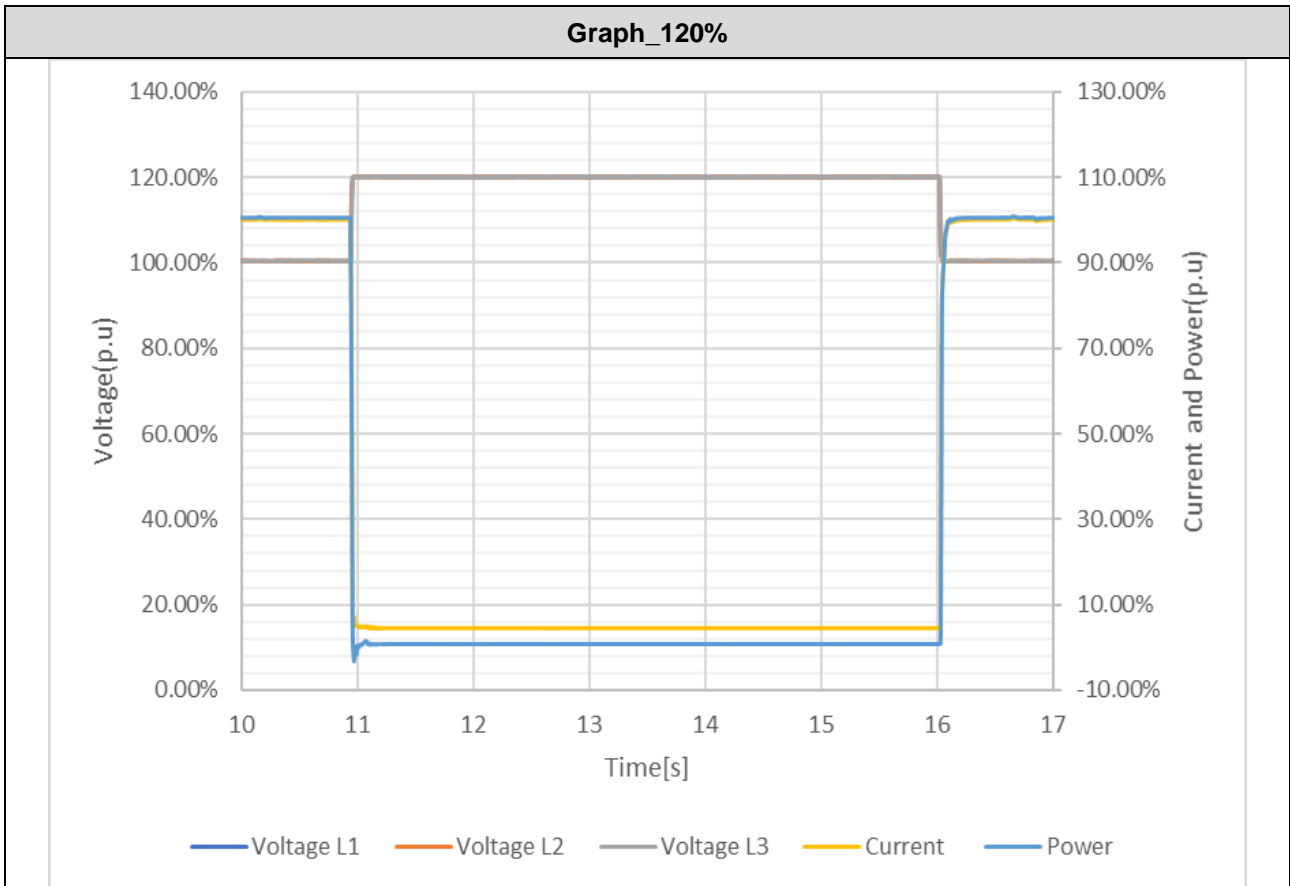

Test at partial load (20%)							
Udip	Type	t min (ms)	U meas. (%)			T meas. (ms)	P recover (s)
			R	S	T		
125%	3 ph	100	125.04	125.14	125.18	190	0.14
120%	3 ph	5000	120.08	120.13	120.13	5090	0.14
115%	3 ph	60000	115.21	115.12	115.12	60130	0.12

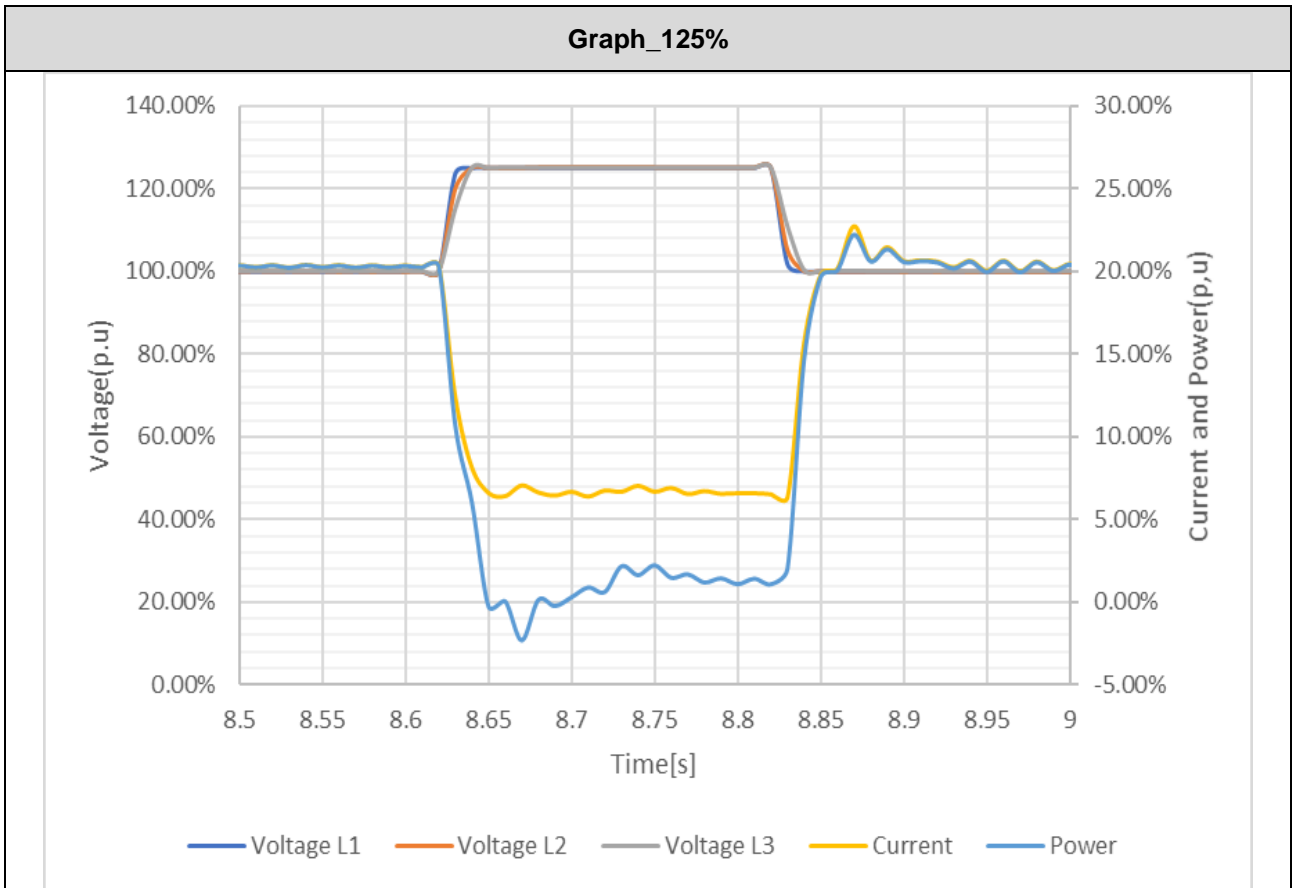

Graph_120%

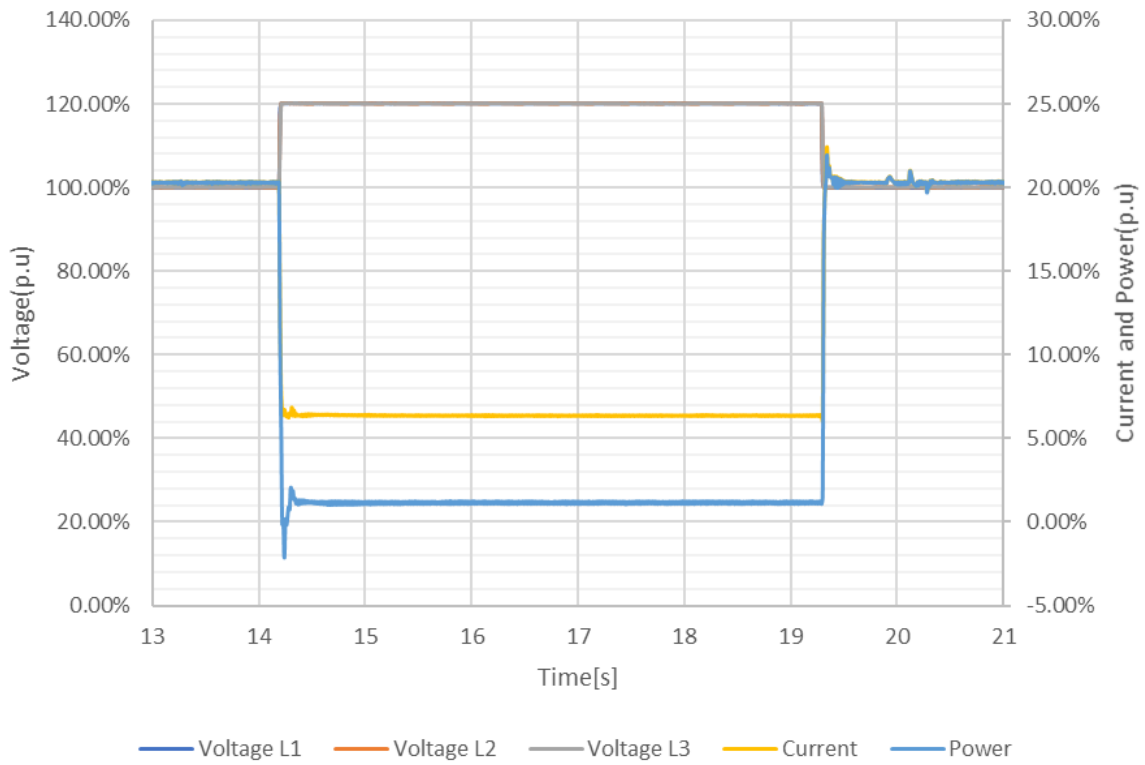

Graph_115%

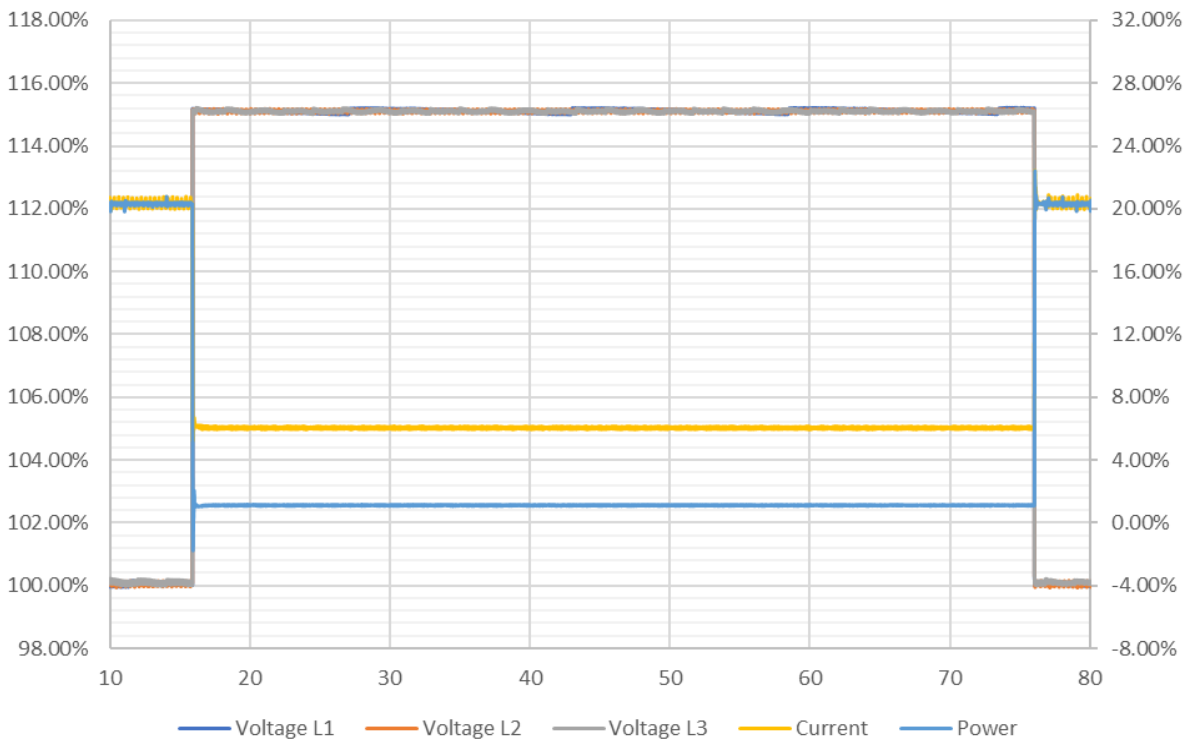

4.6.1	Table: Power response to over frequency					P
Test 1	100% Pn, f1 =50.2Hz; droop=12%; f-stop deactivated, with delay of 2 s					
	f (Hz)	Measured output Power (W)	Calculated from standard characteristic curve P (W)	Tolerance between measured P and calculated P (W)	Tolerance Limit (W)	
	50Hz ± 0.01Hz	50.00	33040.99	33000.00	--	--
	50.2Hz ± 0.01Hz	50.20	33037.79	33000.00	--	--
	50.70Hz ± 0.01Hz	50.70	30267.75	30250.00	17.75	± 3300
	51.15Hz ± 0.01Hz	51.15	27712.44	27775.00	-62.56	± 3300
	52.0Hz ± 0.01Hz	52.00	22912.95	23100.00	-187.05	± 3300
	51.15Hz ± 0.01Hz	51.15	27710.86	27775.00	-64.14	± 3300
	50.70Hz ± 0.01Hz	50.70	30246.98	30250.00	-3.02	± 3300
	50.2Hz ± 0.01Hz	50.20	33033.40	33000.00	--	--
	50Hz ± 0.01Hz	50.00	33032.54	33000.00	--	--
Test 2	100% Pn, f1 =50.2Hz; droop=2%; f-stop deactivated, no delay					
	f (Hz)	Measured output Power (W)	Calculated from standard characteristic curve P (W)	Tolerance between measured P and calculated P (W)	Tolerance Limit (W)	
	50Hz ± 0.01Hz	50.00	33027.02	33000.00	--	--
	50.2Hz ± 0.01Hz	50.20	33010.88	33000.00	--	--
	50.70Hz ± 0.01Hz	50.70	16556.06	16500.00	56.06	± 3300
	51.15Hz ± 0.01Hz	51.15	1719.87	1650.00	69.87	± 3300
	52.0Hz ± 0.01Hz	52.00	21.52	0.00	21.52	± 3300
	51.15Hz ± 0.01Hz	51.15	1719.17	1650.00	69.17	± 3300
	50.70Hz ± 0.01Hz	50.70	16568.14	16500.00	68.14	± 3300
	50.2Hz ± 0.01Hz	50.20	33047.33	33000.00	--	--
	50Hz ± 0.01Hz	50.00	33040.23	33000.00	--	--
Test 3	50% Pn, f1 =52.0Hz; droop=5%; f-stop deactivated, no delay					
	f (Hz)	Measured output Power (W)	Calculated from standard characteristic curve P (W)	Tolerance between measured P and calculated P (W)	Tolerance Limit (W)	
	50Hz ± 0.01Hz	50.00	16516.23	--	--	--
	51.0Hz ± 0.01Hz	51.00	16514.68	16500.00	14.68	± 3300
	51.70Hz ± 0.01Hz	51.70	16514.36	16500.00	14.36	± 3300
	52.0Hz ± 0.01Hz	52.00	16514.75	16500.00	14.75	± 3300
	51.70Hz ± 0.01Hz	51.70	16514.24	16500.00	14.24	± 3300
	51.00Hz ± 0.01Hz	51.00	16513.23	16500.00	13.23	± 3300
50Hz ± 0.01Hz	50.00	16513.00	--	--	--	

Test 4	100% Pn, f1 =50.2Hz; droop=5%; f-stop =50.1, no delay, Deactivation time t_{stop} 30s				
	f (Hz)	Measured output Power (W)	Calculated from standard characteristic curve P (W)	Tolerance between measured P and calculated P (W)	Tolerance Limit (W)
50Hz ± 0.01Hz	50.00	33147.49	33000.00	--	--
50.2Hz ± 0.01Hz	50.20	33144.97	33000.00	--	--
50.70Hz ± 0.01Hz	50.70	26443.23	26400.00	43.23	± 3300
51.15Hz ± 0.01Hz	51.15	20419.18	20460.00	-40.82	± 3300
52.0Hz ± 0.01Hz	52.00	9212.16	9240.00	-27.84	± 3300
51.15Hz ± 0.01Hz	51.15	9212.34	9240.00	-27.66	± 3300
50.70Hz ± 0.01Hz	50.70	9212.29	9240.00	-27.71	± 3300
50.2Hz ± 0.01Hz	50.20	9212.35	9240.00	-27.65	± 3300
50Hz ± 0.01Hz	50.00	33145.23	9240.00	--	--

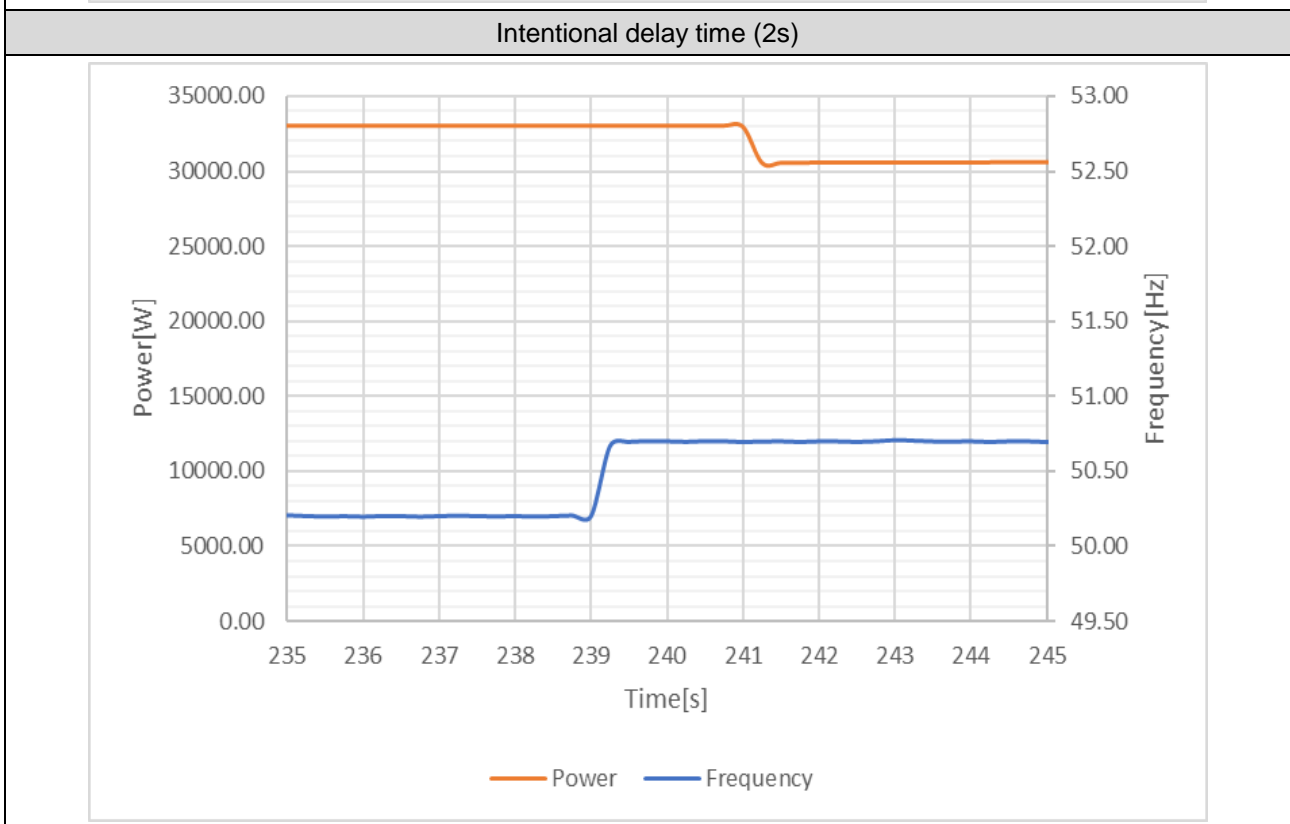
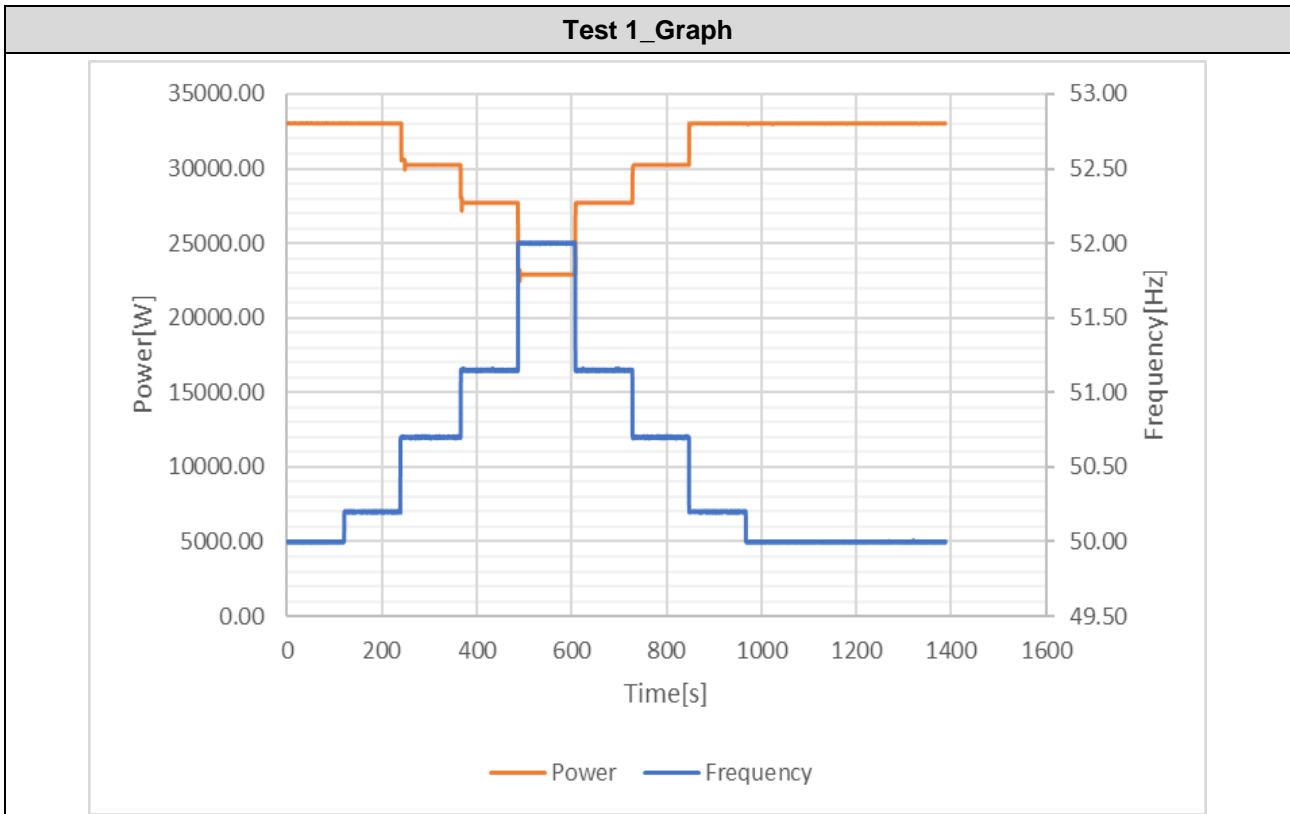

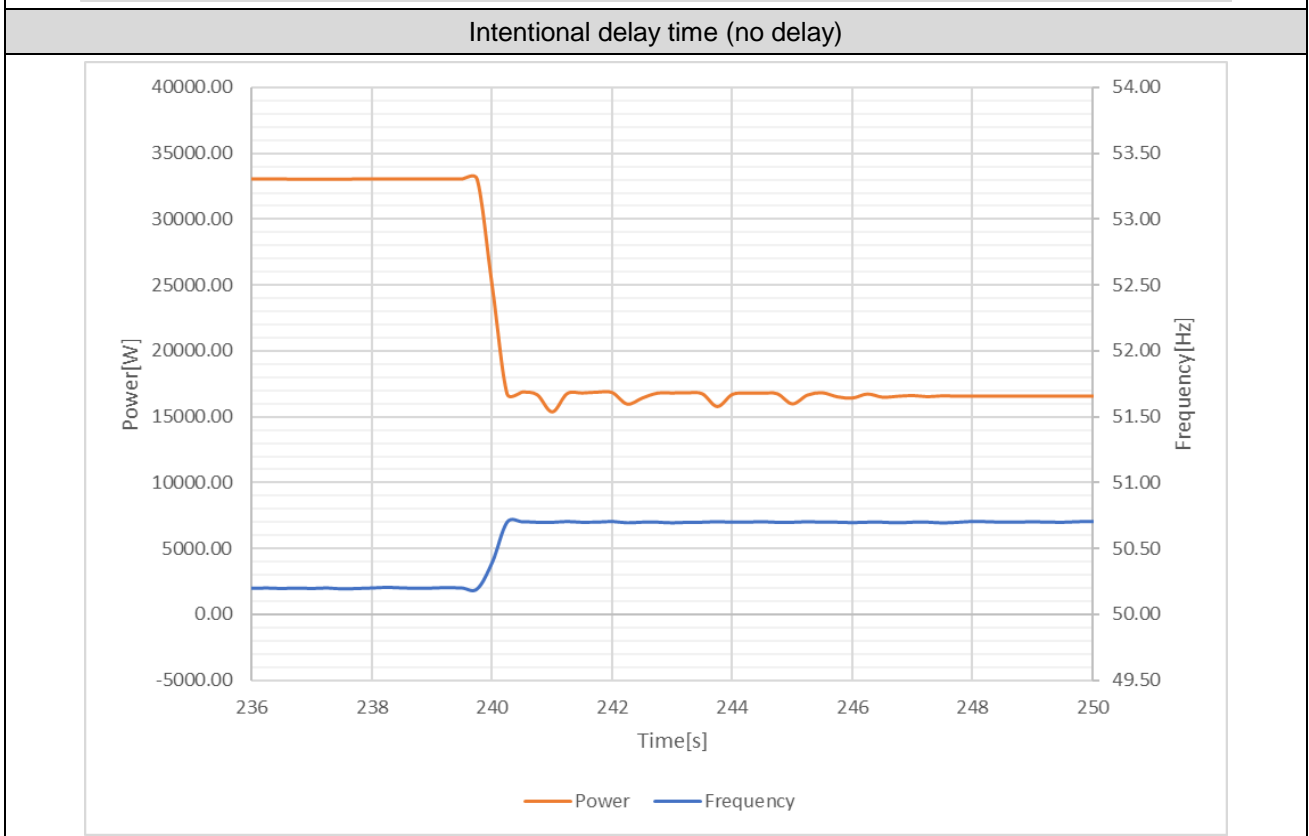
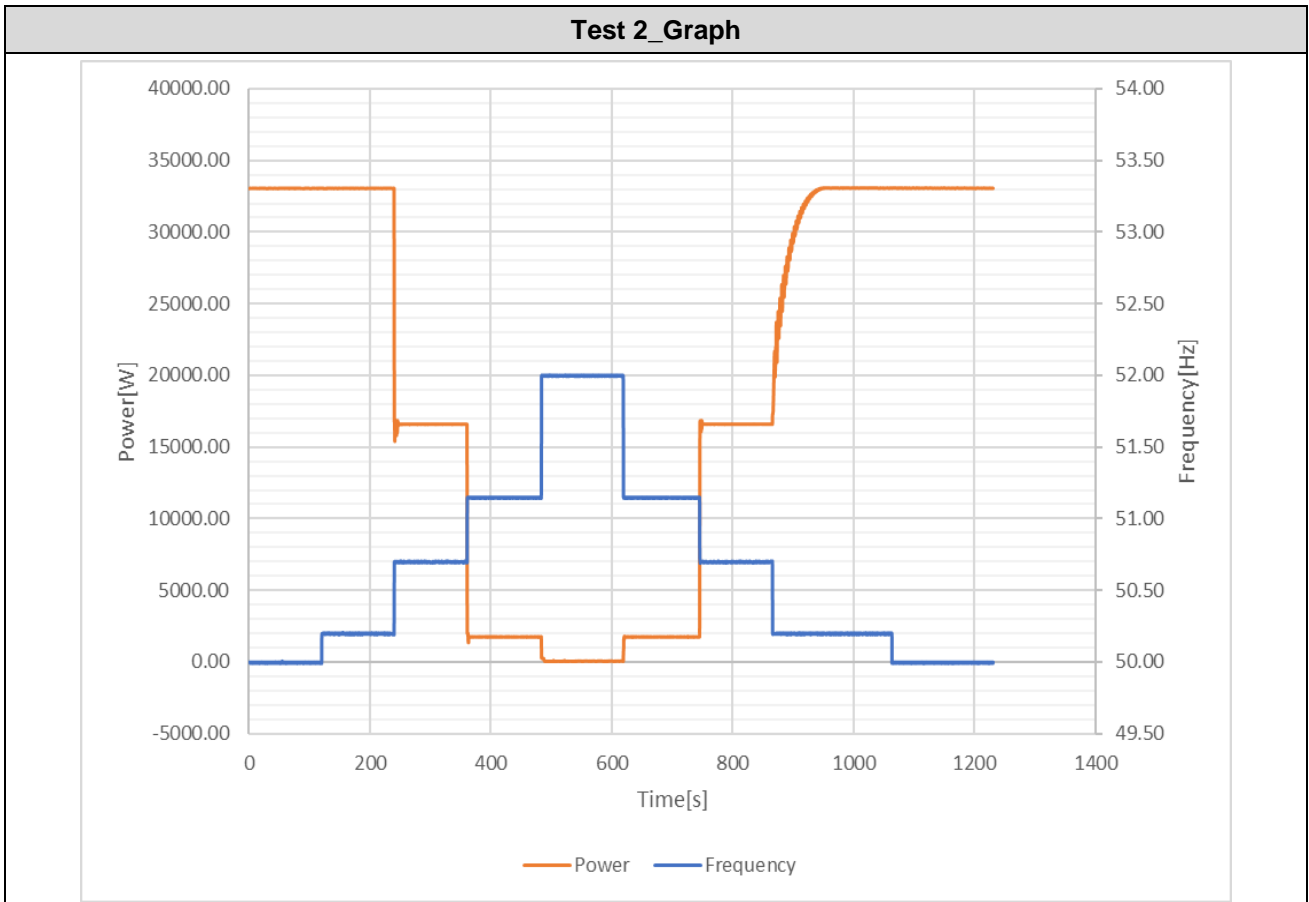

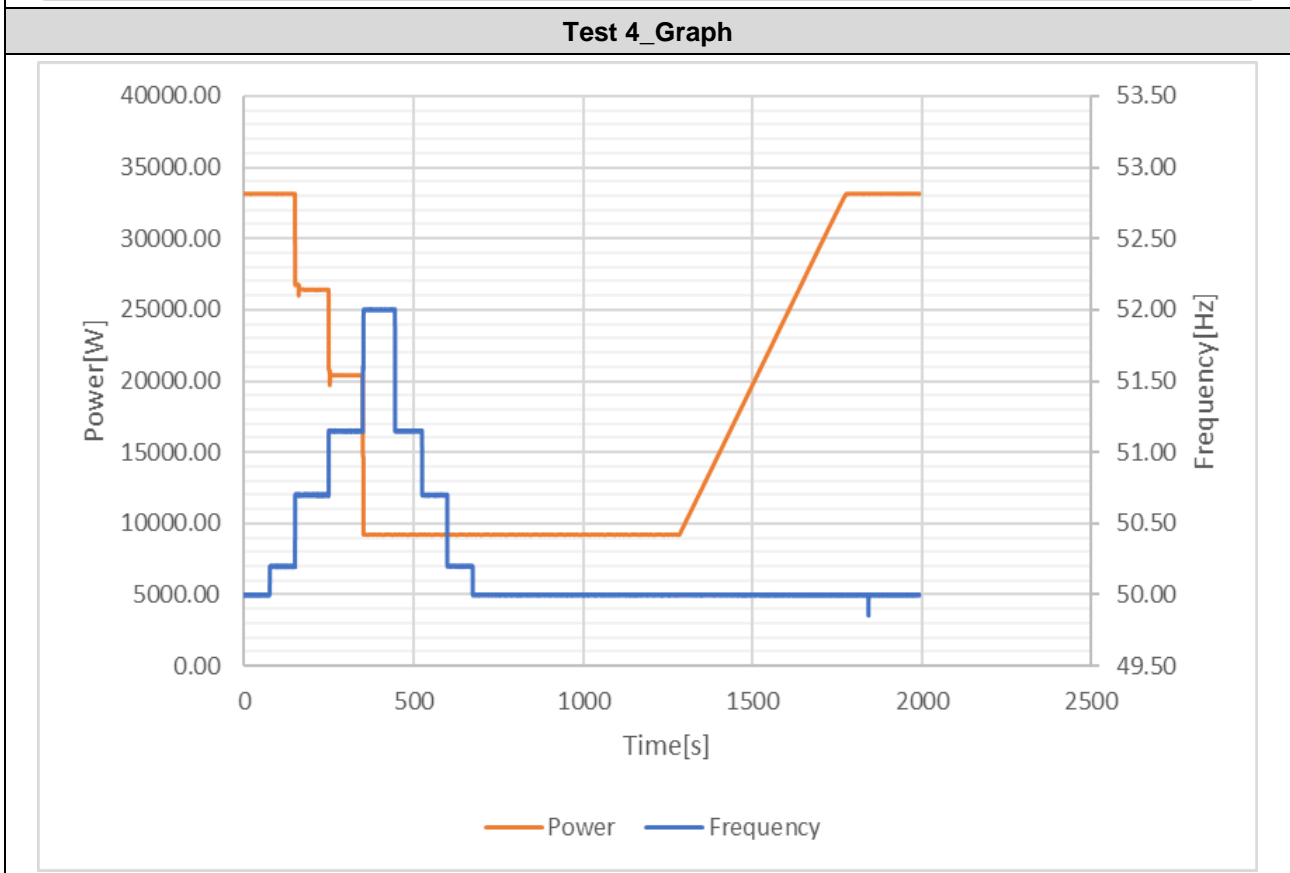
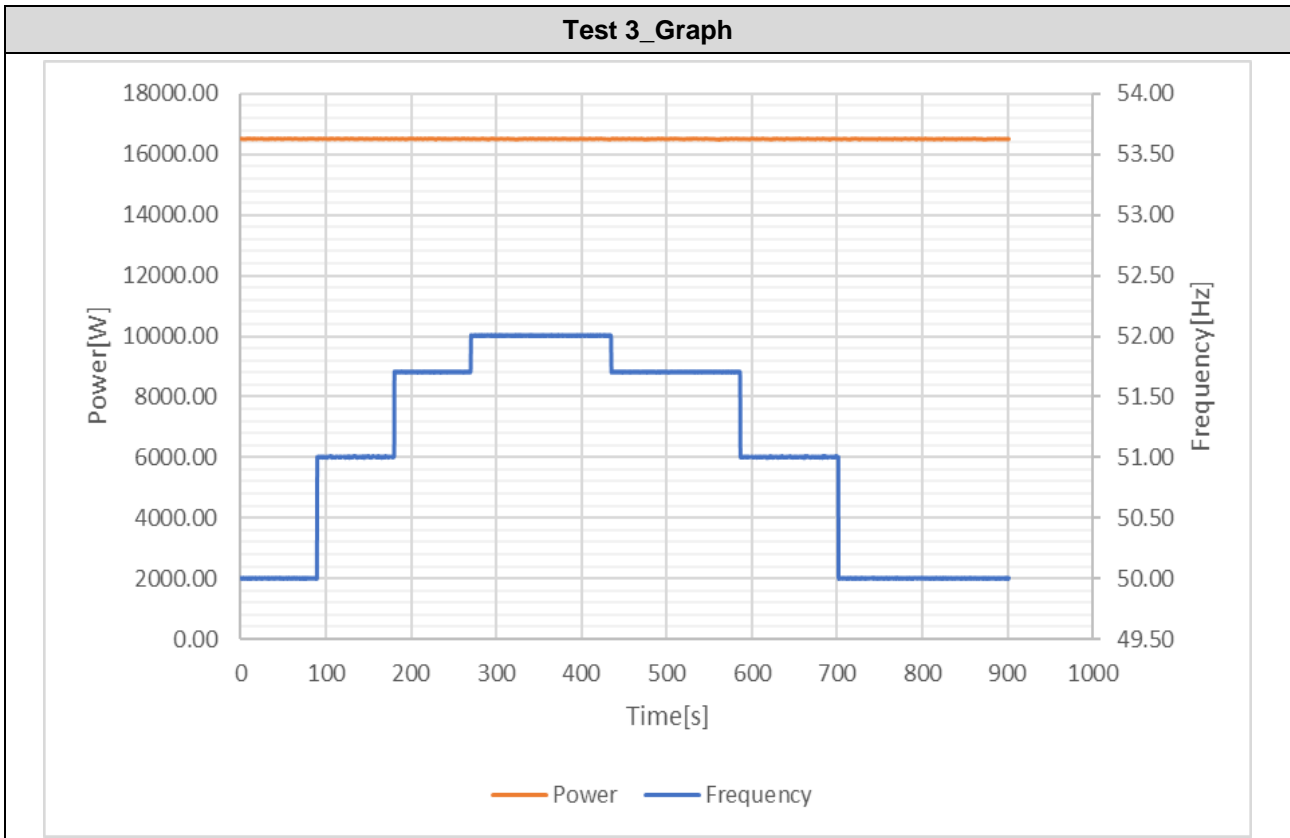

4.6.2	Table: Power response to under frequency					P
Test 1	0% Pn, f1 =49.8Hz; droop=12%; with delay of 2 s					
	f (Hz)	Measured output Power (W)	Calculated from standard characteristic curve P (W)	Tolerance between measured P and calculated P (W)	Tolerance Limit	
50Hz ± 0.01Hz	50.00	-33.79	--	--	--	
49.8Hz ± 0.01Hz	49.80	-31.39	0.00	-31.39	± 3300	
49.0Hz ± 0.01z	49.00	4559.98	4400.00	159.98	± 3300	
48.0Hz ± 0.01z	48.00	10144.96	9900.00	244.96	± 3300	
47.0Hz ± 0.01z	47.00	15707.97	15400.00	307.97	± 3300	
46.0Hz ± 0.01z	46.00	21283.06	20900.00	383.06	± 3300	
47.0Hz ± 0.01z	47.00	15716.75	15400.00	316.75	± 3300	
48.0Hz ± 0.01z	48.00	10156.45	9900.00	256.45	± 3300	
49.0Hz ± 0.01z	49.00	4562.59	4400.00	162.59	± 3300	
49.8Hz ± 0.01Hz	49.80	-33.67	0.00	-33.67	± 3300	
50.0Hz ± 0.01Hz	50.00	-33.01	--	--	--	

Test 2	0% Pn, f1 =49.8Hz; droop=5%; no delay				
	f (Hz)	Measured output Power (W)	Calculated from standard characteristic curve P (W)	Tolerance between measured P and calculated P (W)	Tolerance Limit
50Hz ± 0.01Hz	50.00	-32.63	--	--	--
49.8Hz ± 0.01Hz	49.80	53.02	0.00	53.02	± 3300
49.0Hz ± 0.01Hz	49.00	10682.14	10560.00	122.14	± 3300
48.0Hz ± 0.01Hz	48.00	24006.46	23760.00	246.46	± 3300
47.0Hz ± 0.01Hz	47.00	33021.13	33000.00	21.13	± 3300
46.0Hz ± 0.01Hz	46.00	33014.13	33000.00	14.13	± 3300
47.0Hz ± 0.01Hz	47.00	33016.29	33000.00	16.29	± 3300
48.0Hz ± 0.01Hz	48.00	23993.58	23760.00	233.58	± 3300
49.0Hz ± 0.01Hz	49.00	10686.46	10560.00	126.46	± 3300
49.8Hz ± 0.01Hz	49.80	-28.22	0.00	-28.22	± 3300
50.0Hz ± 0.01Hz	50.00	-33.29	--	--	--

Test 3	50% Pn, f1 =46.0Hz; droop=5%; no delay				
	f (Hz)	Measured output Power (W)	Calculated from standard characteristic curve P (W)	Tolerance between measured P and calculated P (W)	Tolerance Limit
50Hz ± 0.01Hz	50.00	16541.15	--	--	--
49.0Hz ± 0.01Hz	49.00	16547.93	16500.00	47.93	± 3300
48.0Hz ± 0.01Hz	48.00	16548.49	16500.00	48.49	± 3300
47.0Hz ± 0.01Hz	47.00	16547.22	16500.00	47.22	± 3300
46.0Hz ± 0.01Hz	46.00	16404.66	16500.00	-95.34	± 3300
47.0Hz ± 0.01Hz	47.00	16546.08	16500.00	46.08	± 3300
48.0Hz ± 0.01Hz	48.00	16549.39	16500.00	49.39	± 3300
49.0Hz ± 0.01Hz	49.00	16549.98	16500.00	49.98	± 3300
50.0Hz ± 0.01Hz	50.00	16551.72	--	--	--

Test 4	50% Pn, f1 =49.8Hz; droop=5%, no delay;				
	f (Hz)	Measured output Power (W)	Calculated from standard characteristic curve P (W)	Tolerance between measured P and calculated P (W)	Tolerance Limit
50Hz ± 0.01Hz	50.00	16550.88	--	--	--
49.8Hz ± 0.01Hz	49.80	16715.59	16500.00	215.59	± 3300
49.0Hz ± 0.01Hz	49.00	27314.68	27060.00	254.68	± 3300
48.0Hz ± 0.01Hz	48.00	32956.94	33000.00	-43.06	± 3300
47.0Hz ± 0.01Hz	47.00	33016.36	33000.00	16.36	± 3300
46.0Hz ± 0.01Hz	46.00	33009.67	33000.00	9.67	± 3300
47.0Hz ± 0.01Hz	47.00	33012.08	33000.00	12.08	± 3300
48.0Hz ± 0.01Hz	48.00	33013.18	33000.00	13.18	± 3300
49.0Hz ± 0.01Hz	49.00	27319.57	27060.00	259.57	± 3300
49.8Hz ± 0.01Hz	49.80	16628.38	16500.00	128.38	± 3300
50.0Hz ± 0.01Hz	50.00	16610.11	--	--	--

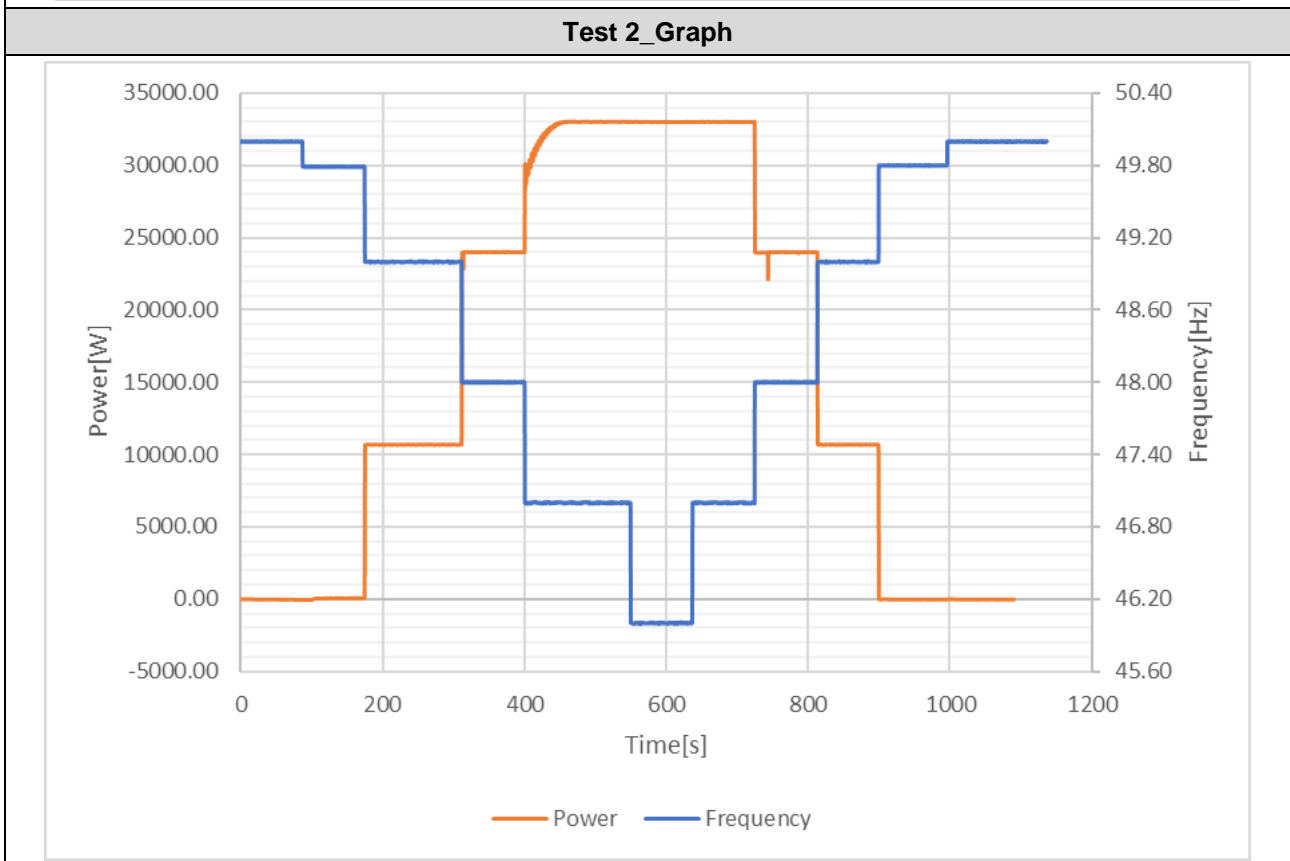
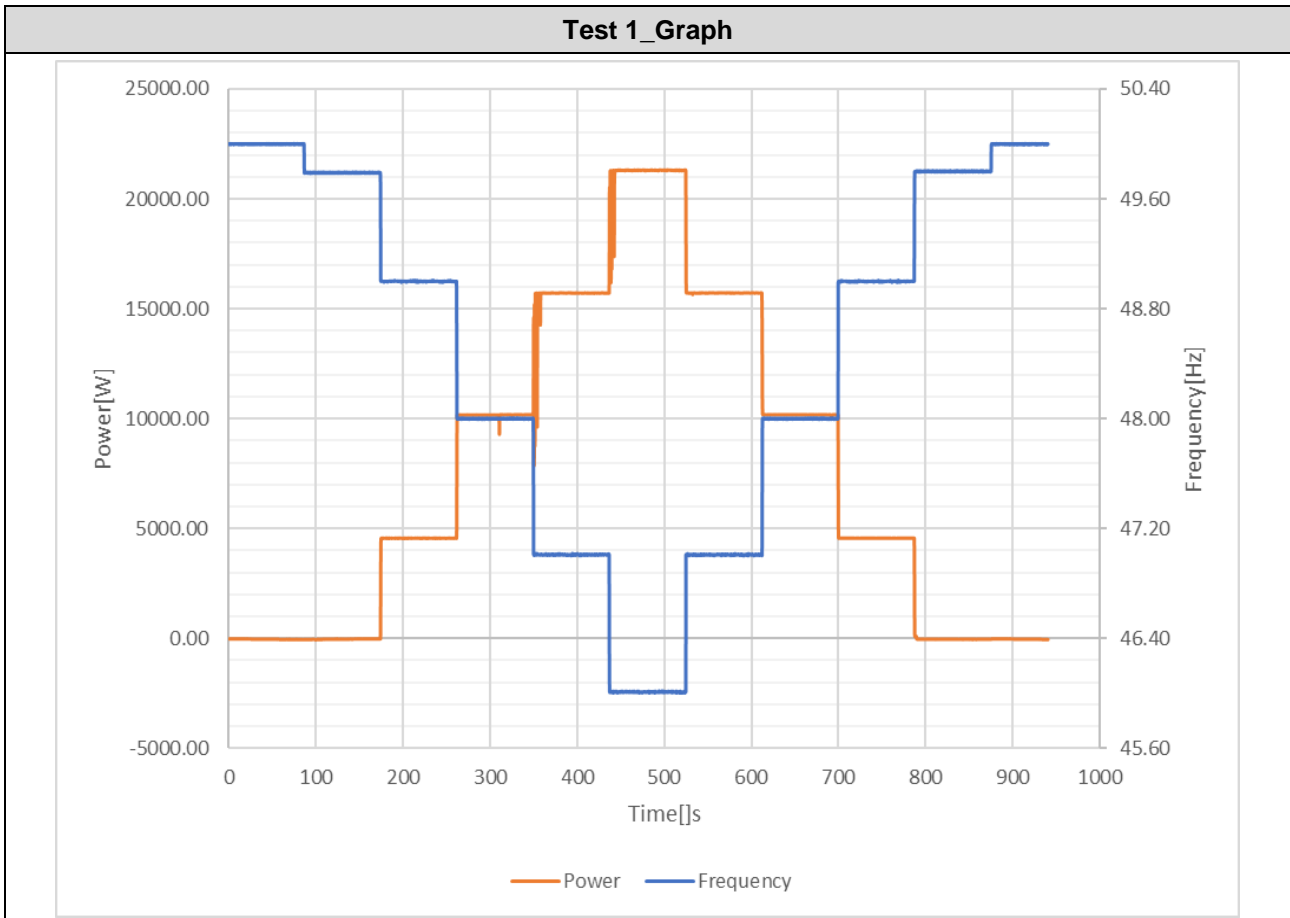

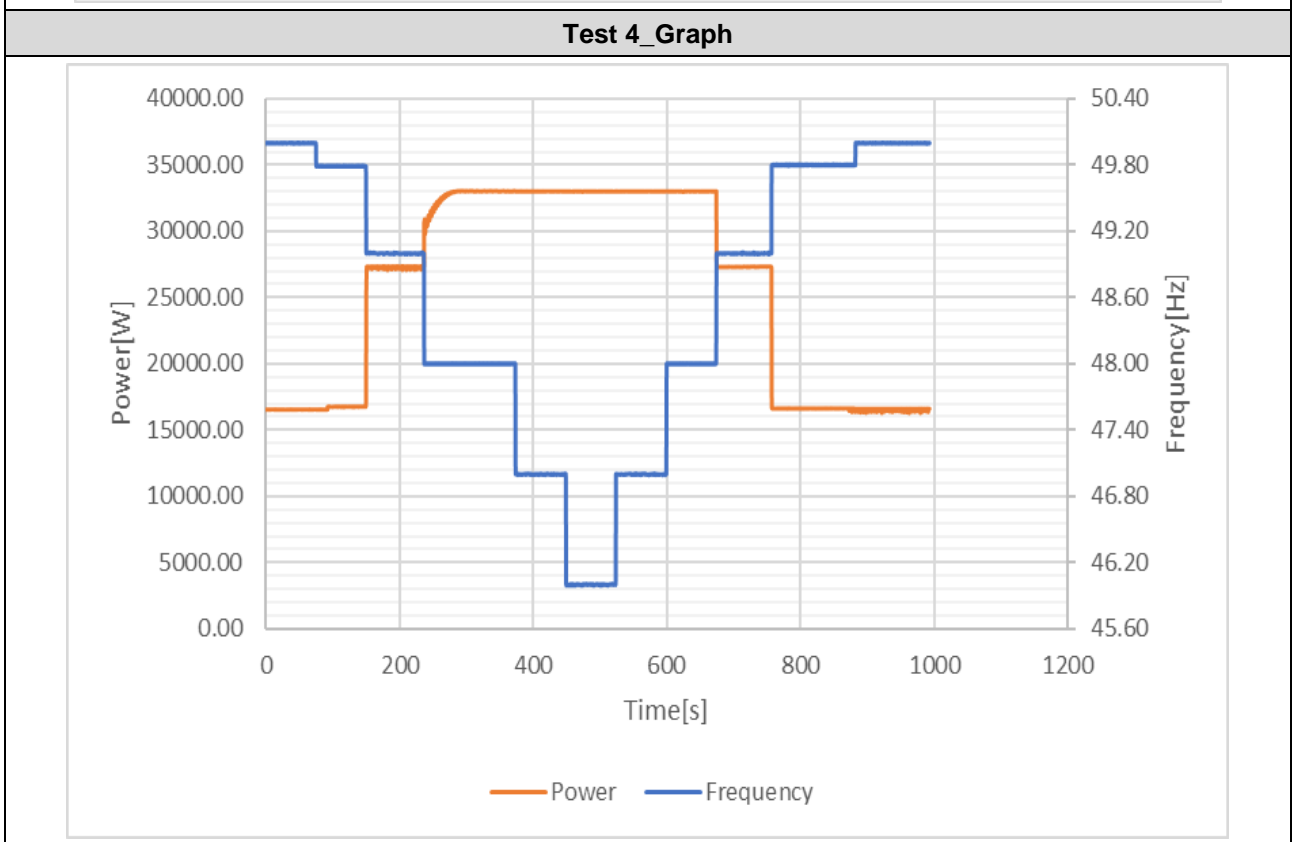
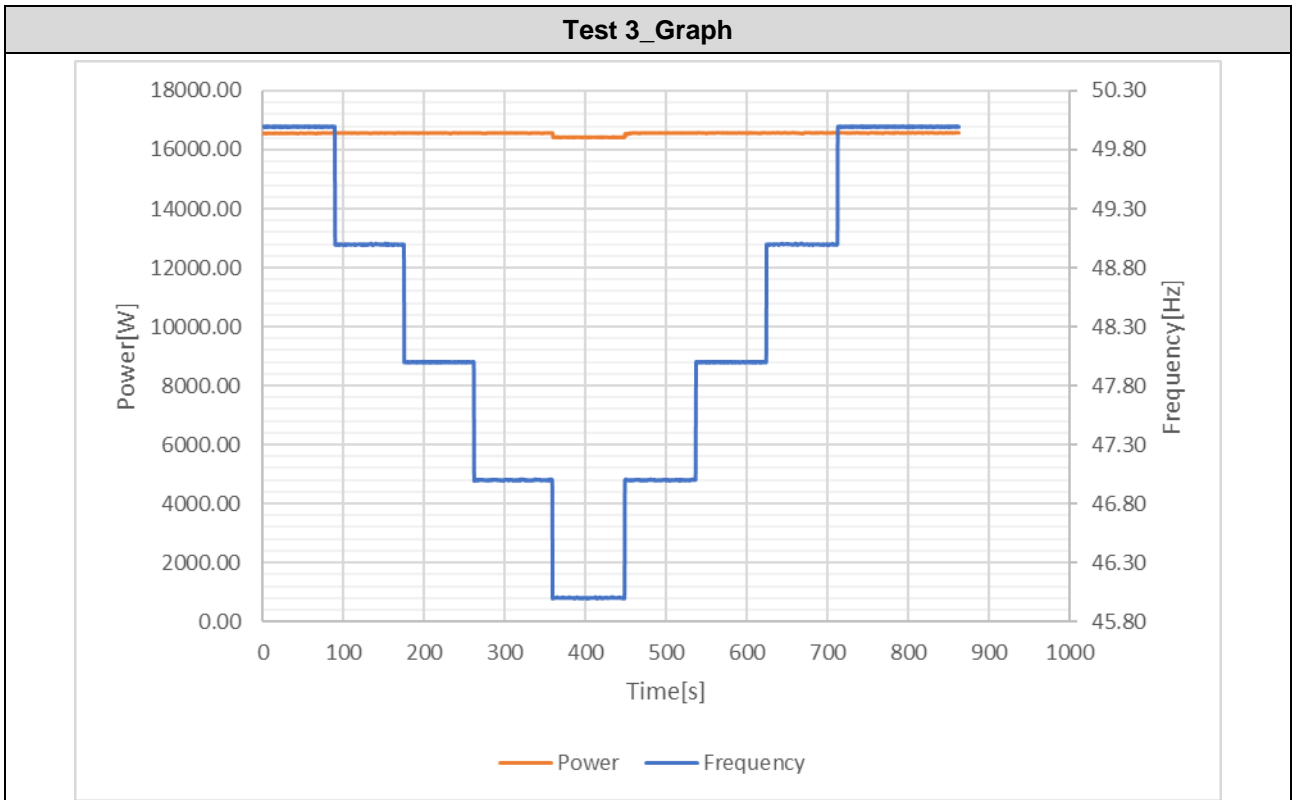

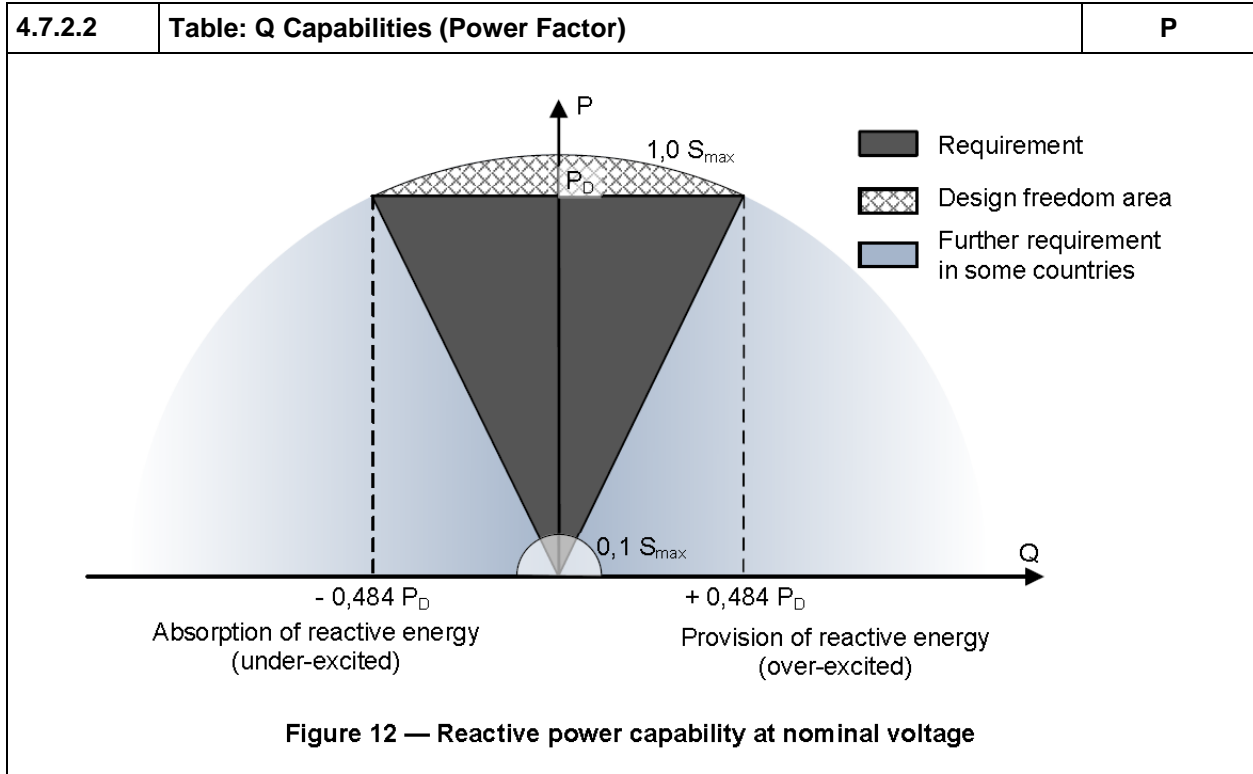

Lagging PF=0.9:								
P/Pn[%] setpoint	P[W]	Q[Var]	Cosφ	Cosφ Set- point	Δcosφ	Q[Var] setpoint	ΔQ/S _{max} [%]	LIMITE [%]
10	3299.58	-1615.38	0.8981	0.9	-0.0019	-1598.26	-0.05	± 2
20	6664.14	-3192.30	0.9019	0.9	0.0019	-3196.53	0.01	± 2
30	10009.62	-4799.78	0.9017	0.9	0.0017	-4794.79	-0.02	± 2
40	13278.96	-6367.00	0.9017	0.9	0.0017	-6393.05	0.08	± 2
50	16539.46	-7927.87	0.9018	0.9	0.0018	-7991.31	0.19	± 2
60	19861.24	-9521.63	0.9017	0.9	0.0017	-9589.58	0.21	± 2
70	23137.17	-11095.37	0.9017	0.9	0.0017	-11187.84	0.28	± 2
80	26430.89	-12676.43	0.9017	0.9	0.0017	-12786.10	0.33	± 2
90	29686.86	-14251.15	0.9015	0.9	0.0015	-14384.37	0.40	± 2
100*	33152.44	-15940.10	0.9012	0.9	--	--	--	--

* Remark: Due to the max current limit, the active power can't get to 100%.

Leading PF=0.9:								
P/Pn[%] setpoint	P[W]	Q[Var]	Cosφ	Cosφ Set-point	Δcosφ	Q[Var] setpoint	ΔQ/S _{max} [%]	LIMITE [%]
10	3376.20	1677.25	0.8956	0.9	-0.0044	1598.26	0.24	± 2
20	6667.98	3289.68	0.8968	0.9	-0.0032	3196.53	0.28	± 2
30	9951.95	4862.60	0.8985	0.9	-0.0015	4794.79	0.21	± 2
40	13256.88	6483.10	0.8983	0.9	-0.0017	6393.05	0.27	± 2
50	16552.12	8118.57	0.8978	0.9	-0.0022	7991.31	0.39	± 2
60	19842.73	9747.75	0.8975	0.9	-0.0025	9589.58	0.48	± 2
70	23155.57	11385.27	0.8974	0.9	-0.0026	11187.84	0.60	± 2
80	26420.62	12999.83	0.8973	0.9	-0.0027	12786.10	0.65	± 2
90	29711.29	14643.69	0.8970	0.9	-0.0030	14384.37	0.79	± 2
100	32962.09	16238.42	0.8971	0.9	--	--	--	--
Q=0:								
P/Pn[%] setpoint	P[W]	Q[Var]	Cosφ	Cosφ Set-point	Δcosφ	Q[Var] setpoint	ΔQ/S _{max} [%]	LIMITE [%]
10	3315.72	278.80	0.9963	1	-0.0037	0.00	0.84	± 2
20	6678.68	249.80	0.9993	1	-0.0007	0.00	0.76	± 2
30	9968.89	280.76	0.9996	1	-0.0004	0.00	0.85	± 2
40	13256.93	357.67	0.9996	1	-0.0004	0.00	1.08	± 2
50	16593.57	430.99	0.9996	1	-0.0004	0.00	1.31	± 2
60	19887.97	506.41	0.9997	1	-0.0003	0.00	1.53	± 2
70	23192.74	512.80	0.9996	1	-0.0004	0.00	1.55	± 2
80	26495.98	530.98	0.9996	1	-0.0004	0.00	1.61	± 2
90	29793.59	579.14	0.9995	1	-0.0005	0.00	1.75	± 2
100	33121.91	566.09	0.9995	1	-0.0005	0.00	1.72	± 2

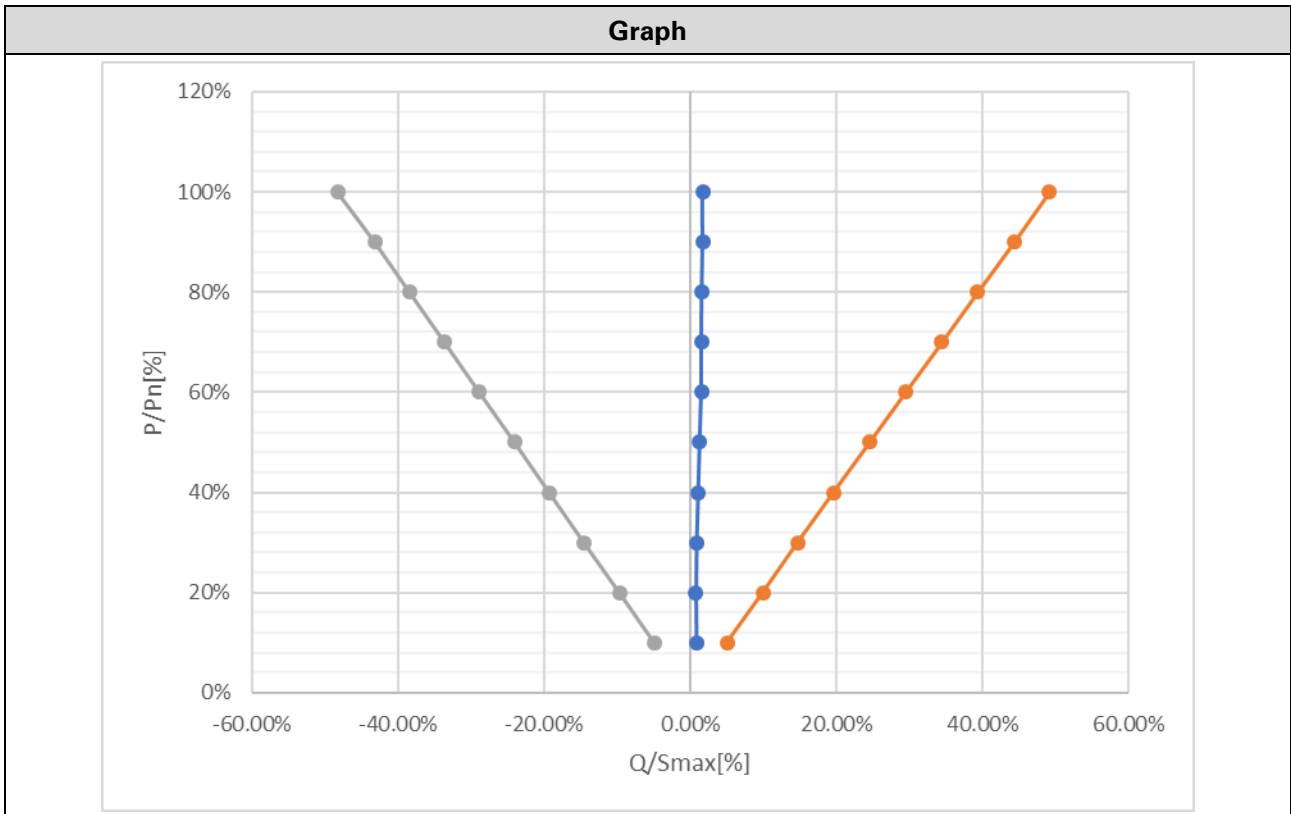

Q=48.43%Pn						
P/Pn[%] setpoint	P[W]	Q[Var]	Cosp	Q[Var] setpoint	$\Delta Q/S_{max}$ [%]	LIMITE [%]
10	3261.93	16171.58	0.1977	15981.9	0.57	± 2
20	6660.33	15862.95	0.3871	15981.9	-0.36	± 2
30	9970.06	15898.96	0.5313	15981.9	-0.25	± 2
40	13240.08	15920.81	0.6394	15981.9	-0.19	± 2
50	16590.81	15935.38	0.7212	15981.9	-0.14	± 2
60	19843.31	15925.79	0.7799	15981.9	-0.17	± 2
70	23132.84	15930.05	0.8236	15981.9	-0.16	± 2
80	26456.71	15942.77	0.8565	15981.9	-0.12	± 2
90	29757.73	15982.68	0.8810	15981.9	0.00	± 2
100	33079.34	16045.68	0.8997	15981.9	0.19	± 2
Q=-48.43%Pn						
P/Pn[%] setpoint	P[W]	Q[Var]	Cosp	Q[Var] setpoint	$\Delta Q/S_{max}$ [%]	LIMITE [%]
10	3315.26	-15642.03	0.2073	-15981.9	1.03	± 2
20	6630.89	-16072.19	0.3814	-15981.9	-0.27	± 2
30	10008.91	-16147.80	0.5268	-15981.9	-0.50	± 2
40	13247.64	-15962.75	0.6386	-15981.9	0.06	± 2
50	16557.73	-15898.62	0.7213	-15981.9	0.25	± 2
60	19900.56	-15963.07	0.7801	-15981.9	0.06	± 2
70	23222.84	-15976.84	0.8239	-15981.9	0.02	± 2
80	26543.79	-15992.09	0.8566	-15981.9	-0.03	± 2
90	29757.31	-16044.16	0.8802	-15981.9	-0.19	± 2
100	33120.63	-16107.28	0.8993	-15981.9	-0.38	± 2

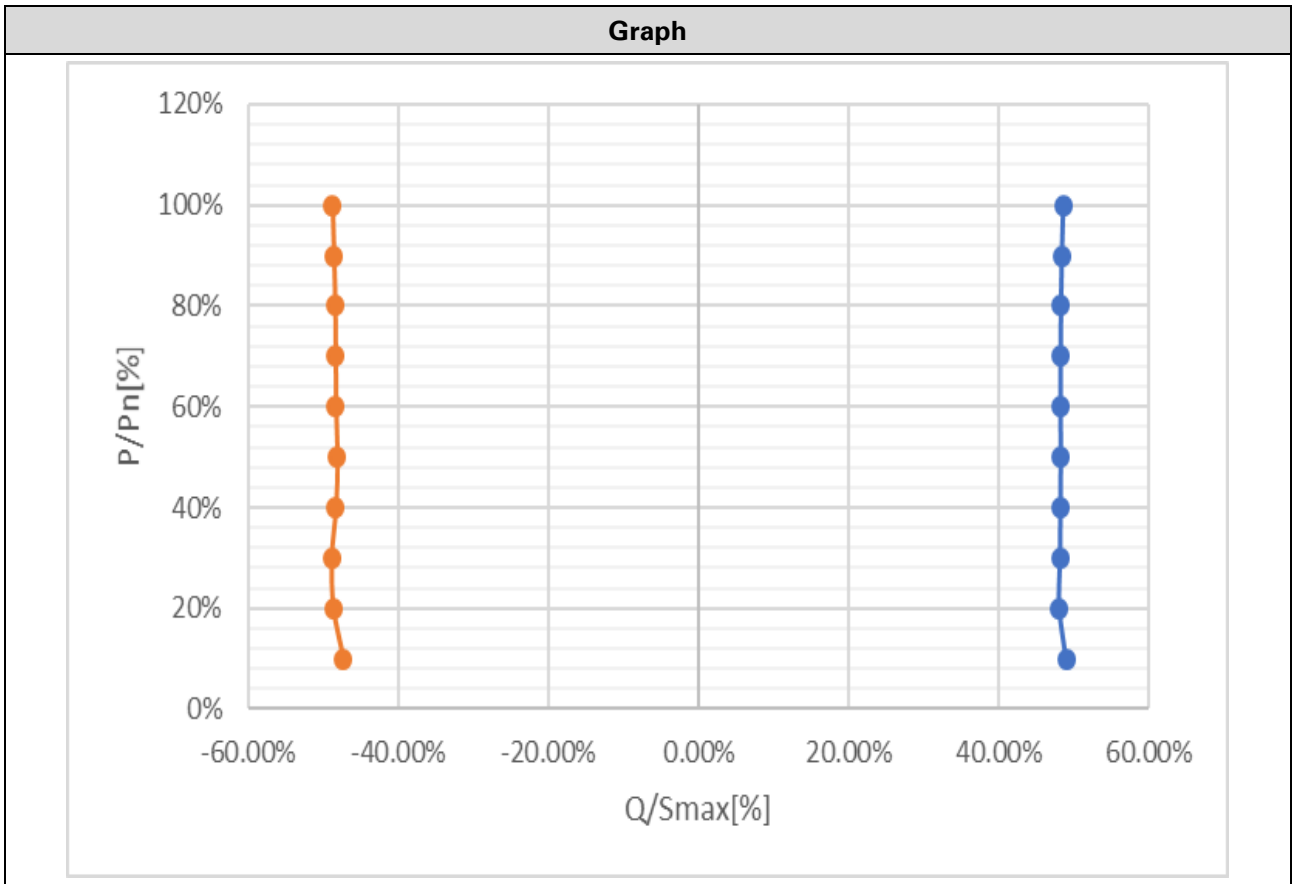
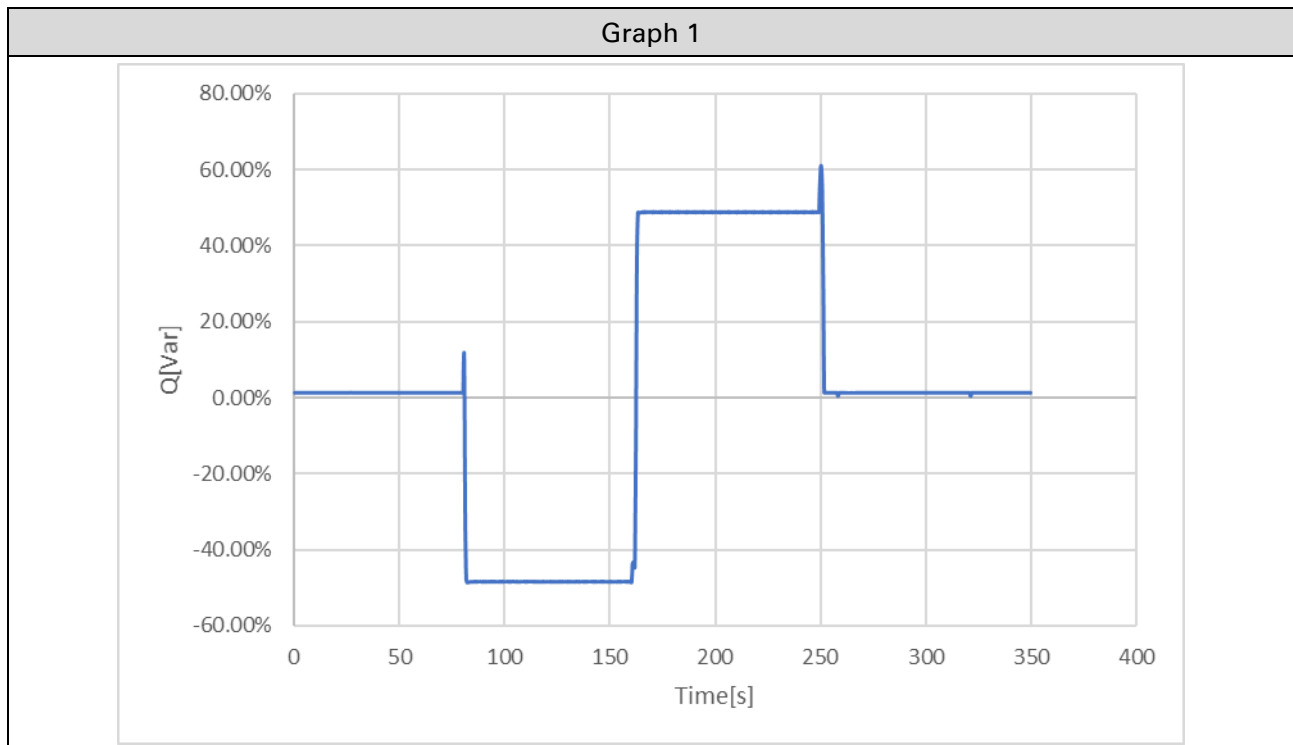
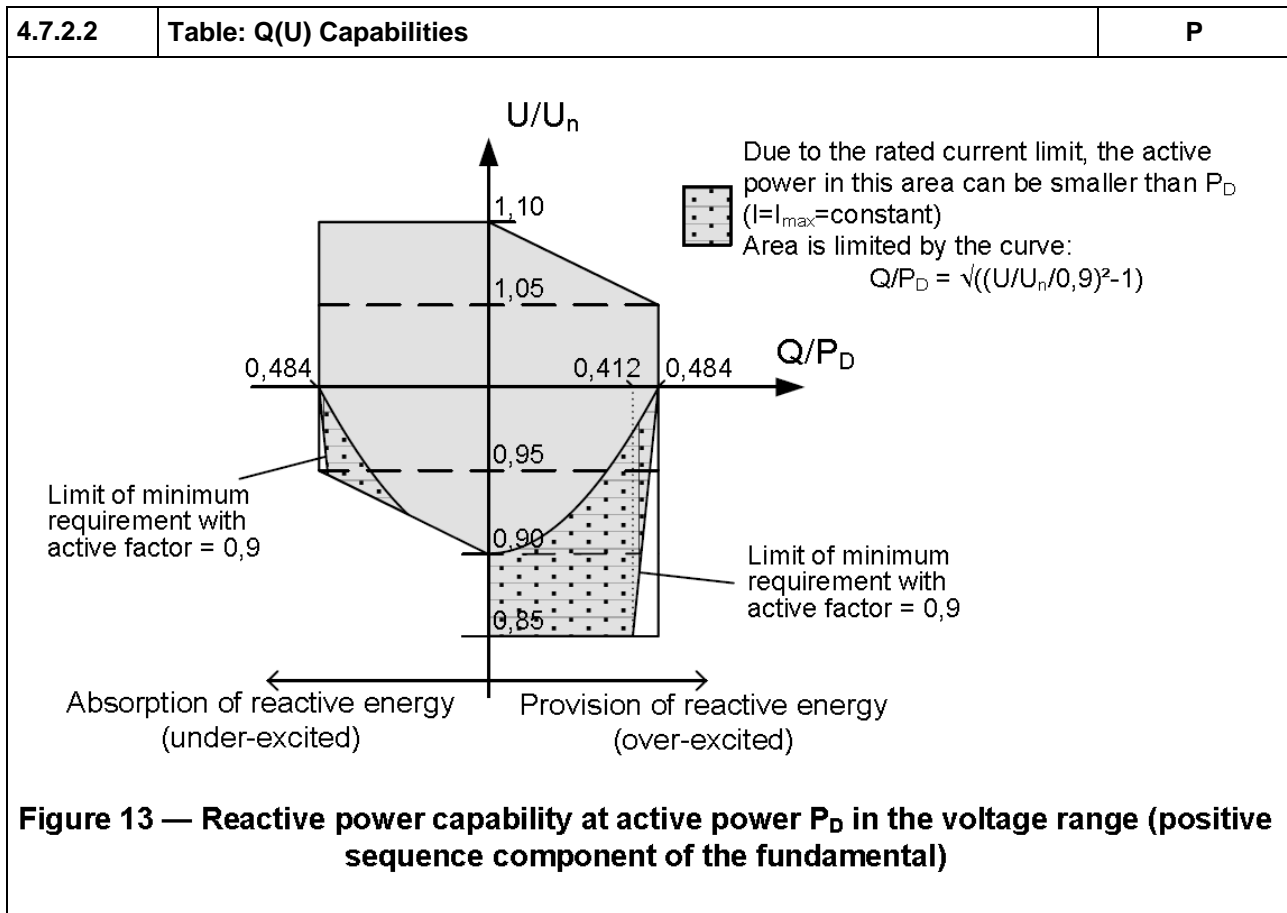

Table: Check the settling time					P	
Test 1			Test 2			
Output power [%]	Qmax ind [VA]	Qmax cap [VA]	Output power [%]	Qmax ind [VA]	Qmax cap [VA]	
100% Pn	-16044.96	16052.48	50% Pn	-15958.00	16081.41	
Test 1 (see Graph 1): 100% Pn						
Point	Output power	Transient	Vac	QE60 [VA]	Tr [s]	limit [s]
1	33113.11	0 → Qmax ind	229.00	-16044.96	2.00	60
2	33039.10	Qmax ind → Qmax cap	233.07	16052.48	3.50	60
3	33193.00	Qmax cap → 0	228.34	423.81	2.50	60
Test 2 : 50% Pn						
Point	Output power	transient	Vac	QE60 [VA]	Tr [s]	limit [s]
1	16559.85	0 → Qmax ind	229.76	-15958.00	2.30	60
2	16534.04	Qmax ind → Qmax cap	230.78	16081.41	3.40	60
3	16604.03	Qmax cap → 0	229.94	421.53	3.10	60





Over-excited:

AC output				Reactive power measured		
Voltage setting [V/V _n]	Measured			Reactive power [Var]	Value [Q/P _n]	Limits
	Voltage [V]	[V/V _n]	Active power [W]			
1.10	253.27	1.10	33195.88	524.65	0.0159	±0.02
1.08	249.12	1.08	33198.13	6407.44	0.1942	0.194±0.02
1.05	241.75	1.05	33074.79	15929.96	0.4827	--
1.00	230.63	1.00	33105.58	15944.71	0.4832	--
0.95	218.79	0.95	31382.19	15987.57	0.4845	--
0.92	211.95	0.92	29879.21	15998.70	0.4848	--
0.90	207.27	0.90	29383.03	15983.78	0.4844	--
0.85	195.79	0.85	27319.06	16010.46	0.4852	--

Under-excited:						
AC output				Reactive power measured		
Voltage setting [V/V _n]	Measured			Reactive power [Var]	Value [Q/P _n]	Limits
	Voltage [V]	[V/V _n]	Active power [W]			
1.10	253.04	1.10	32979.96	-15956.08	-0.4835	--
1.08	248.25	1.08	33031.09	-15984.27	-0.4844	--
1.05	241.24	1.05	33029.22	-16016.13	-0.4853	--
1.00	230.13	1.00	32978.95	-16066.30	-0.4869	--
0.95	218.13	0.95	31243.10	-15883.35	-0.4813	--
0.92	211.52	0.92	31869.28	-5782.29	-0.1752	-0.175±0.02
0.90	207.24	0.90	32961.50	526.72	0.0160	±0.02

4.7.2.3.3	Table: Q Control. Voltage related control mode					P
P/Pn [%] Set-point	Vac [V] Set-point	P/Pn [%] measured	Vac [V] Measured	Q [VAr] measured	Q [Var] expected	ΔQ [Var] ($\leq \pm 5\%$ Pn)
< 20 %	1,07 Vn	17.09	246.23	251.93	≈ 0 (< $\pm 5\%$ Pn)	0.76
< 20 %	1,09 Vn	17.10	250.63	253.51	≈ 0 (< $\pm 5\%$ Pn)	0.77
<20 % \rightarrow 30 %	1,09 Vn	30.13	250.53	-8007.24	-7992.60 (within 10sec)	-0.04
40 %	1,09 Vn	40.06	250.59	-8085.07	-7992.60	-0.28
50 %	1,09 Vn	50.17	250.58	-7894.08	-7992.60	0.30
60 %	1,09 Vn	60.15	250.55	-7768.84	-7992.60	0.68
70 %	1,09 Vn	70.21	250.61	-7857.17	-7992.60	0.41
80 %	1,09 Vn	80.13	250.74	-8082.63	-7992.60	-0.27
90 %	1,09 Vn	90.13	250.75	-7988.91	-7992.60	0.01
100 %	1,09 Vn	100.20	250.86	-8191.61	-7992.60	-0.60
100 %	1,1 Vn	99.91	253.25	-15883.76	-15981.90	0.30
100 % \rightarrow 10 %	1,1 Vn	9.65	253.00	-15919.40	-15981.90	0.19
10 % \rightarrow $\leq 5\%$	1,1 Vn	1.85	253.38	270.66	≈ 0 (< $\pm 5\%$ Pn)	0.82
P/Pn [%] Set-point	Vac [V] Set-point	P/Pn [%] measured	Vac [V] Measured	Q [VAr] measured	Q [Var] expected	ΔQ [Var] ($\leq \pm 5\%$ Pn)
< 20 %	0.93 Vn	17.04	214.03	241.36	≈ 0 (< $\pm 5\%$ Pn)	0.73
< 20 %	0.91 Vn	17.02	209.29	235.14	≈ 0 (< $\pm 5\%$ Pn)	0.71
<20 % \rightarrow 30 %	0.91 Vn	30.00	209.15	8128.06	7992.60 (within 10sec)	0.41
40 %	0.91 Vn	40.09	209.19	7879.79	7992.60	-0.34
50 %	0.91 Vn	50.12	209.19	8039.83	7992.60	0.14
60 %	0.91 Vn	60.14	209.30	7945.63	7992.60	-0.14
70 %	0.91 Vn	70.13	209.33	8113.97	7992.60	0.37
80 %	0.91 Vn	80.04	209.47	8102.79	7992.60	0.33
90 %	0.91 Vn	89.97	209.68	7907.07	7992.60	-0.26

100 %	0.91 Vn	99.10	209.77	8259.11	7992.60	0.81
100 %	0.90 Vn	88.31	206.82	16171.13	15981.90	0.57
100 % → 10 %	0.90 Vn	9.47	207.10	15993.09	15981.90	0.03
10 % → ≤ 5 %	0.91 Vn	1.82	206.76	281.09	≈ 0 (< ± 5 % Pn)	0.85

Graph: Lock-in at 1.08Vn

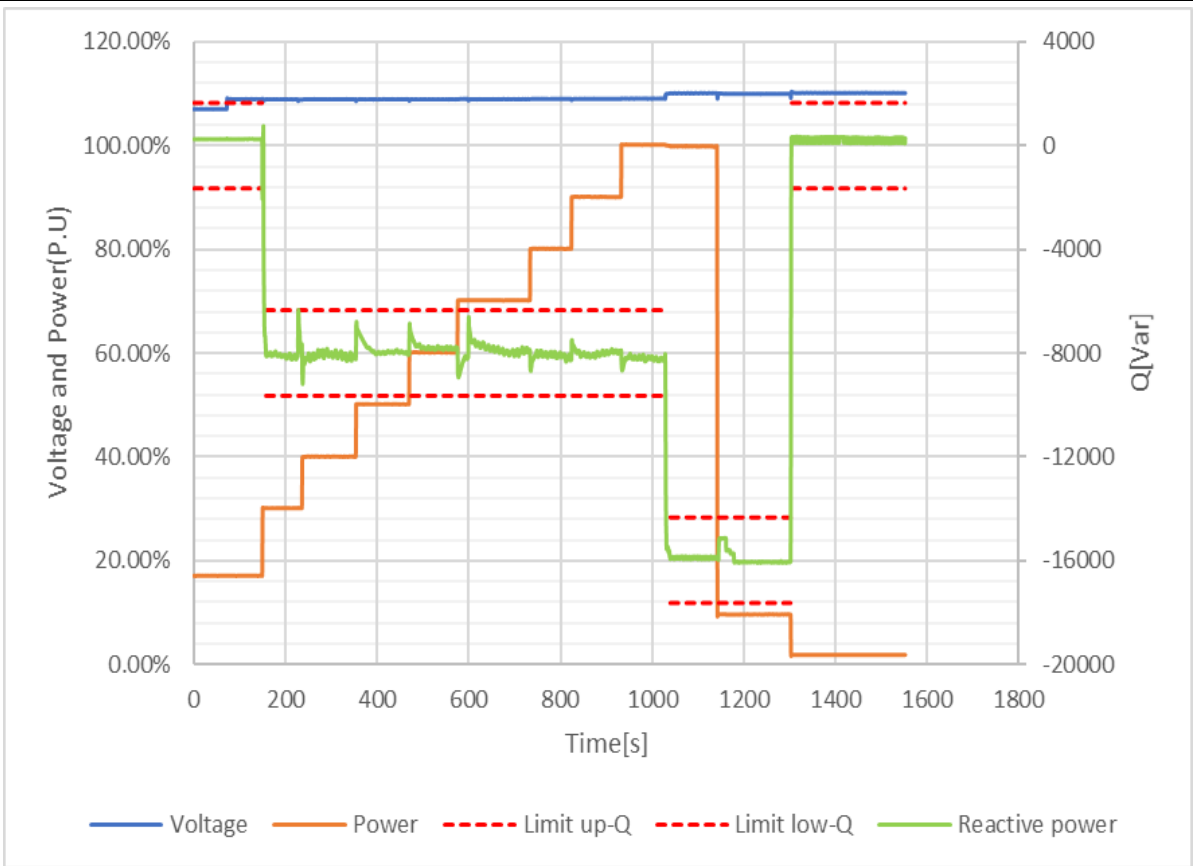

Graph: Lock-in at 0.92Vn

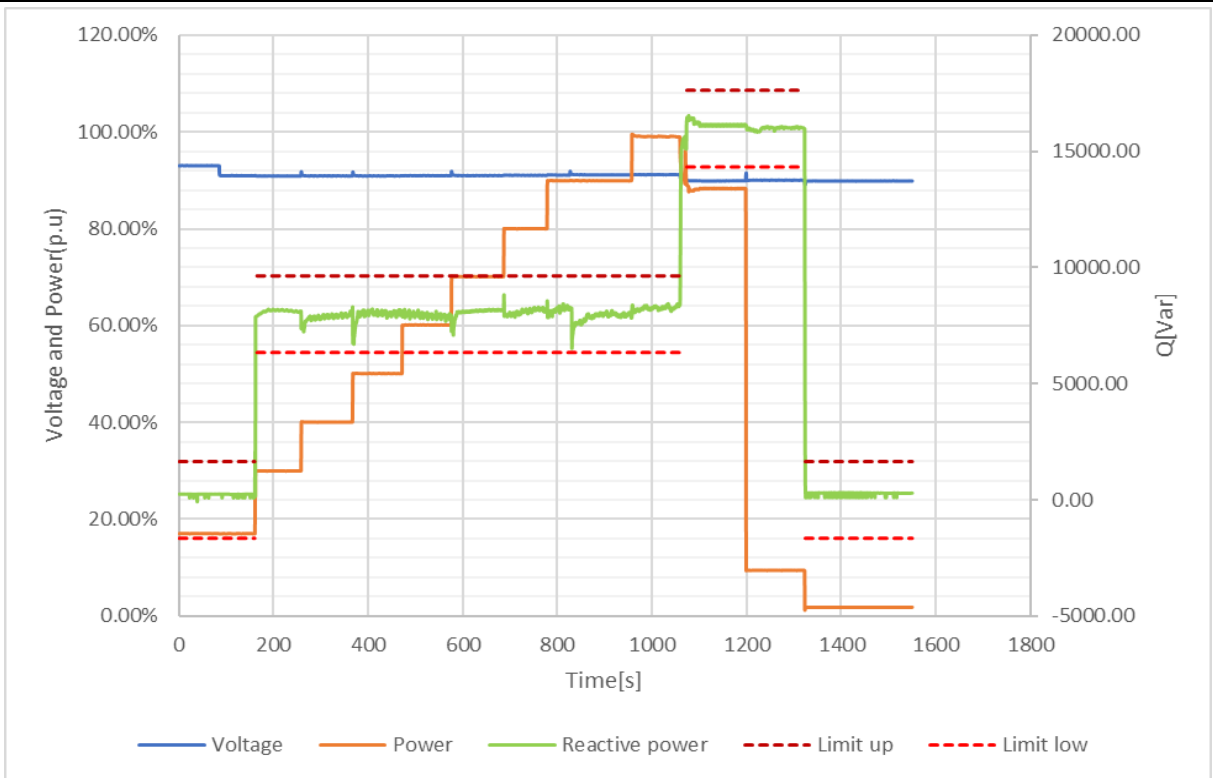

4.7.2.3.4 Table: Q Control Power related control modes								P	
P Desired (%Sn)	P measured (%Sn)	Q measured (Var)	Voltage Desired (%Un)	Voltage Measured (%Un)	Power Factor desired (cos φ)	Power Factor measured (cos φ)	ΔQ (%S _{Max})	Limit (%S _{Max})	
20%	20.12	253.45	<105%	100.08	1.0000	0.9993	0.77	±2	
30%	30.23	279.37	<105%	100.11	1.0000	0.9996	0.85	±2	
40%	40.12	351.78	<105%	100.16	1.0000	0.9996	1.07	±2	
50%	50.18	422.46	<105%	100.21	1.0000	0.9997	1.28	±2	
60%	60.37	499.41	<105%	100.27	1.0000	0.9997	1.51	±2	
60%	60.18	-3948.66	>105%	105.96	0.9800	0.9808	0.22	±2	
70%	70.18	-6613.45	>105%	105.86	0.9600	0.9616	0.38	±2	
80%	80.04	-9348.18	>105%	105.92	0.9400	0.9427	0.71	±2	
90%	89.94	-12311.39	>105%	105.94	0.9200	0.9237	1.03	±2	
100%	100.18	-15614.99	>105%	105.98	0.9000	0.9042	1.11	±2	
100%	100.24	543.55	<100%	98.73	1.0000	0.9994	1.65	±2	

Remark: Tested at lock-in voltage 1.05 Vn and lock-out voltage Vn.

The Lock-in value is adjustable between Vn and 1.1Vn in 0.01V steps, the Lock-out value is adjustable between 0.9Vn and Vn in 0.01V steps

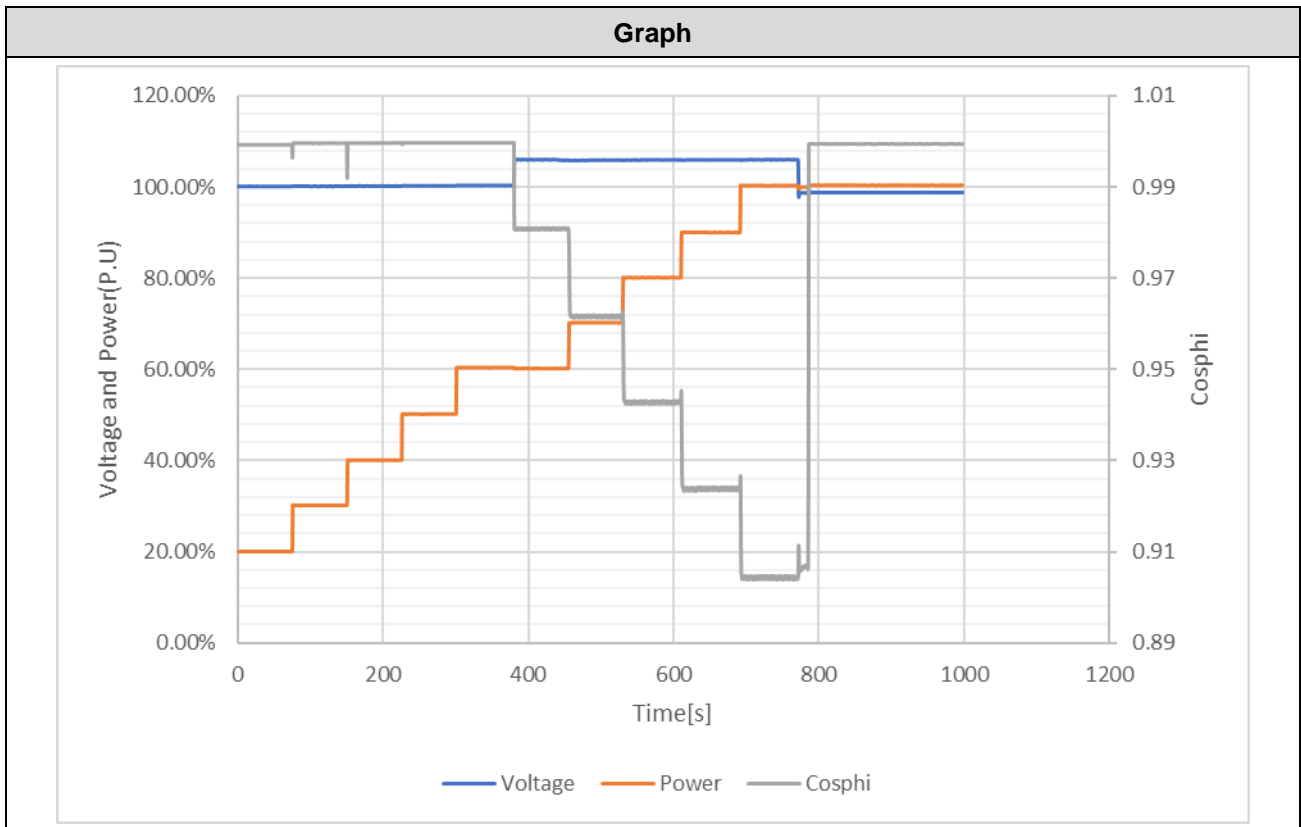

4.7.3	Table: Voltage control by active power			P
Step #	Set voltage vaule V	Measured voltage vaule V/Vn	Measured power values [W]	Measured power [%]
1	207	0.90	32946.60	99.84
2	219	0.95	33019.41	100.06
3	230	1.00	33080.19	100.24
4	240	1.05	33116.59	100.35
5	248	1.08	33165.60	100.50
6	253	1.10	27633.61	83.74
7	257	1.12	20602.44	62.43
8	265	1.15	6445.72	19.53

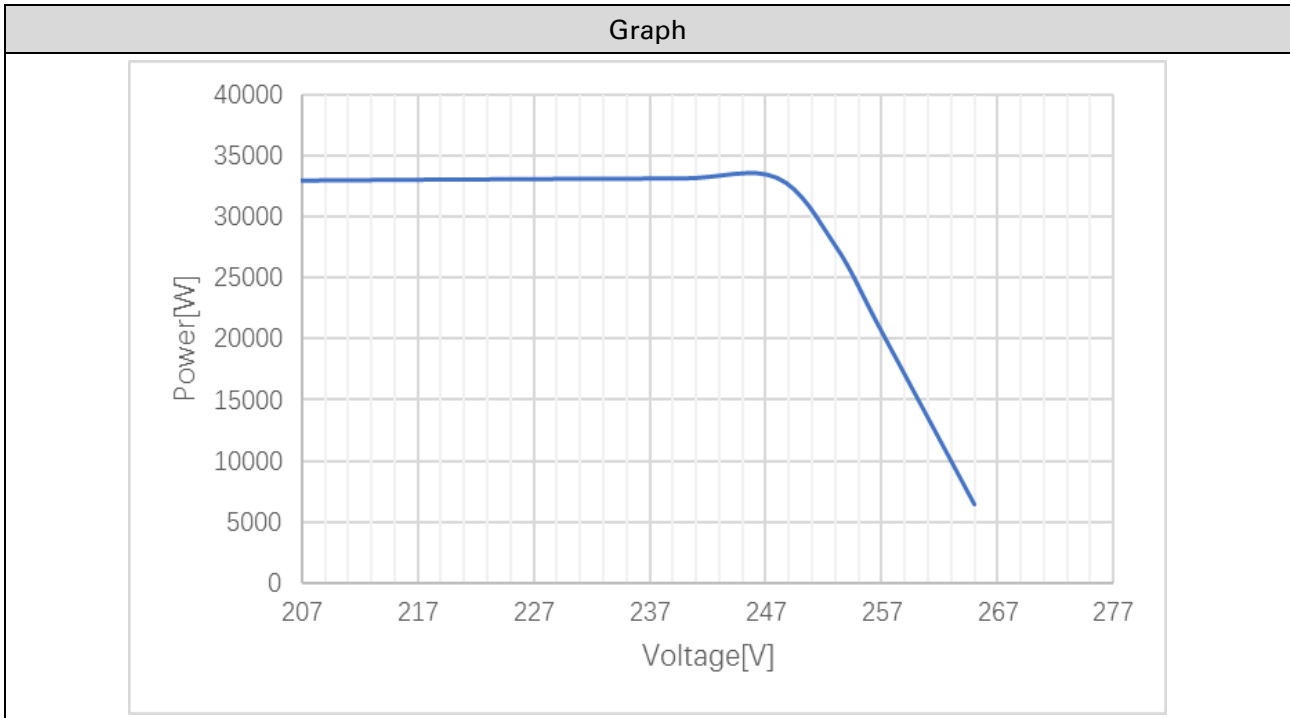

4.8		TABLE: Current harmonics emission test						P	
Model: SOFAR 20000TL-G2									
Normal ambient (EN 61000-3-12)									
Output power 33%									
Watts(kW)				2,198/ 2,198/ 2,192					
Vrms(V)				230,07/ 230,01/ 230,00					
Arms(A)				9,554/ 9,557/ 9,532					
Frequency(Hz)				50,00					
THD* (33% output power)				0,604%/ 0,575%/ 0,627%					
Harmonics	Current Magnitude (A)			% of Fundamental			Phase	Harmonic Current Limits (%)	
	L1	L2	L3	L1	L2	L3			
1st	9,554	9,556	9,532	--	--	--	Three Phase	--	
2nd	0,008	0,009	0,007	0,080	0,094	0,079	Three Phase	8,000	
3rd	0,027	0,009	0,014	0,281	0,094	0,148	Three Phase	21,600	
4th	0,008	0,01	0,009	0,087	0,102	0,090	Three Phase	4,000	
5th	0,015	0,027	0,018	0,158	0,281	0,186	Three Phase	10,700	
6th	0,01	0,008	0,01	0,101	0,080	0,101	Three Phase	2,667	
7th	0,012	0,011	0,015	0,121	0,118	0,157	Three Phase	7,200	
8th	0,008	0,006	0,007	0,079	0,068	0,076	Three Phase	2,000	
9th	0,023	0,008	0,015	0,239	0,082	0,159	Three Phase	3,800	
10th	0,004	0,005	0,004	0,042	0,050	0,043	Three Phase	1,600	
11th	0,007	0,014	0,012	0,072	0,143	0,128	Three Phase	3,100	
12th	0,004	0,004	0,005	0,042	0,045	0,051	Three Phase	1,333	
13th	0,008	0,01	0,017	0,088	0,107	0,183	Three Phase	2,000	
14th	0,003	0,003	0,004	0,035	0,030	0,040	Three Phase	8,000	
15th	0,009	0,006	0,012	0,096	0,067	0,130	Three Phase	N/A	
16th	0,003	0,003	0,003	0,030	0,030	0,030	Three Phase	N/A	
17th	0,013	0,013	0,019	0,131	0,132	0,198	Three Phase	N/A	
18th	0,003	0,003	0,003	0,031	0,034	0,036	Three Phase	N/A	
19th	0,009	0,014	0,017	0,096	0,151	0,179	Three Phase	N/A	
20th	0,003	0,003	0,002	0,027	0,028	0,026	Three Phase	N/A	
21th	0,006	0,004	0,007	0,063	0,045	0,078	Three Phase	N/A	
22th	0,002	0,003	0,002	0,025	0,027	0,025	Three Phase	N/A	
23th	0,016	0,017	0,018	0,171	0,174	0,193	Three Phase	N/A	
24th	0,003	0,003	0,003	0,033	0,028	0,035	Three Phase	N/A	
25th	0,013	0,013	0,015	0,140	0,138	0,158	Three Phase	N/A	
26th	0,003	0,003	0,003	0,027	0,031	0,028	Three Phase	N/A	
27th	0,003	0,003	0,004	0,030	0,032	0,044	Three Phase	N/A	
28th	0,003	0,002	0,002	0,027	0,025	0,026	Three Phase	N/A	
29th	0,011	0,013	0,01	0,112	0,136	0,102	Three Phase	N/A	
30th	0,003	0,003	0,003	0,027	0,028	0,028	Three Phase	N/A	
31th	0,01	0,01	0,008	0,110	0,101	0,087	Three Phase	N/A	
32th	0,002	0,002	0,002	0,024	0,025	0,026	Three Phase	N/A	
33th	0,004	0,003	0,006	0,038	0,035	0,066	Three Phase	N/A	
34th	0,002	0,002	0,002	0,024	0,025	0,025	Three Phase	N/A	
35th	0,01	0,009	0,006	0,108	0,098	0,065	Three Phase	N/A	
36th	0,003	0,003	0,003	0,029	0,031	0,030	Three Phase	N/A	
37th	0,006	0,009	0,006	0,065	0,089	0,061	Three Phase	N/A	
38th	0,002	0,002	0,002	0,023	0,024	0,024	Three Phase	N/A	
39th	0,003	0,003	0,004	0,029	0,036	0,042	Three Phase	N/A	
40th	0,002	0,002	0,002	0,033	0,031	0,028	Three Phase	N/A	

4.8		TABLE: Current harmonics emission test						P	
Model: SOFAR 20000TL-G2									
Normal ambient (EN 61000-3-12) Output power 66%									
Watts(kW)				4,424/ 4,412/ 4,400					
Vrms(V)				230,09/ 230,04/ 230,02					
Arms(A)				19,229/ 19,180/ 19,129					
Frequency(Hz)				50,00					
THD* (66% output power)				0,459%/0,518%/0,468%					
Harmonics	Current Magnitude (A)			% of Fundamental			Phase	Harmonic Current Limits (%)	
	L1	L2	L3	L1	L2	L3			
1st	19,229	19,180	19,129	--	--	--	Three Phase	--	
2nd	0,008	0,012	0,010	0,042	0,061	0,052	Three Phase	8,000	
3rd	0,013	0,043	0,038	0,069	0,226	0,199	Three Phase	21,600	
4th	0,010	0,011	0,011	0,052	0,058	0,056	Three Phase	4,000	
5th	0,052	0,040	0,018	0,272	0,208	0,097	Three Phase	10,700	
6th	0,011	0,009	0,012	0,057	0,047	0,061	Three Phase	2,667	
7th	0,028	0,040	0,024	0,144	0,211	0,124	Three Phase	7,200	
8th	0,009	0,008	0,008	0,046	0,042	0,041	Three Phase	2,000	
9th	0,019	0,023	0,014	0,100	0,122	0,072	Three Phase	3,800	
10th	0,005	0,007	0,006	0,026	0,035	0,029	Three Phase	1,600	
11th	0,022	0,038	0,035	0,115	0,200	0,184	Three Phase	3,100	
12th	0,006	0,004	0,007	0,031	0,023	0,039	Three Phase	1,333	
13th	0,035	0,021	0,020	0,181	0,107	0,104	Three Phase	2,000	
14th	0,005	0,004	0,005	0,027	0,019	0,024	Three Phase	8,000	
15th	0,005	0,023	0,021	0,026	0,120	0,109	Three Phase	N/A	
16th	0,004	0,005	0,004	0,021	0,025	0,018	Three Phase	N/A	
17th	0,011	0,018	0,026	0,055	0,092	0,135	Three Phase	N/A	
18th	0,004	0,003	0,004	0,020	0,017	0,019	Three Phase	N/A	
19th	0,025	0,006	0,024	0,130	0,030	0,123	Three Phase	N/A	
20th	0,003	0,003	0,003	0,016	0,016	0,016	Three Phase	N/A	
21th	0,010	0,010	0,018	0,054	0,053	0,096	Three Phase	N/A	
22th	0,003	0,003	0,003	0,015	0,015	0,015	Three Phase	N/A	
23th	0,006	0,017	0,016	0,030	0,088	0,085	Three Phase	N/A	
24th	0,003	0,003	0,003	0,017	0,014	0,016	Three Phase	N/A	
25th	0,015	0,005	0,015	0,080	0,024	0,077	Three Phase	N/A	
26th	0,003	0,003	0,003	0,015	0,016	0,015	Three Phase	N/A	
27th	0,005	0,009	0,012	0,027	0,048	0,063	Three Phase	N/A	
28th	0,003	0,003	0,003	0,013	0,013	0,014	Three Phase	N/A	
29th	0,004	0,012	0,013	0,022	0,061	0,067	Three Phase	N/A	
30th	0,003	0,002	0,003	0,013	0,013	0,013	Three Phase	N/A	
31th	0,012	0,004	0,009	0,060	0,019	0,049	Three Phase	N/A	
32th	0,002	0,002	0,003	0,013	0,012	0,014	Three Phase	N/A	
33th	0,005	0,008	0,011	0,025	0,040	0,057	Three Phase	N/A	
34th	0,003	0,003	0,003	0,014	0,014	0,014	Three Phase	N/A	
35th	0,004	0,008	0,009	0,020	0,044	0,045	Three Phase	N/A	
36th	0,003	0,003	0,003	0,014	0,015	0,014	Three Phase	N/A	
37th	0,010	0,004	0,010	0,052	0,021	0,051	Three Phase	N/A	
38th	0,002	0,002	0,002	0,013	0,013	0,013	Three Phase	N/A	
39th	0,004	0,006	0,007	0,019	0,033	0,034	Three Phase	N/A	
40th	0,002	0,002	0,002	0,012	0,012	0,012	Three Phase	N/A	

4.8	TABLE: Current harmonics emission test							P
Model: SOFAR 20000TL-G2								
Normal ambient (EN 61000-3-12) Output power 100%								
Watts				6,735/ 6,713/ 6,700				
Vrms				230,12/ 230,06/ 230,05				
Arms				29,271/ 29,181/ 29,127				
Frequency				50,00				
THD				0,447%/ 0,462%/ 0,597%				
Harmonics	Current Magnitude (A)			% of Fundamental			Phase	Harmonic Current Limits (%)
	L1	L2	L3	L1	L2	L3		
1st	29,271	29,181	29,126	--	--	--	Three Phase	--
2nd	0,014	0,015	0,012	0,048	0,053	0,041	Three Phase	8,000
3rd	0,021	0,049	0,062	0,073	0,169	0,212	Three Phase	21,600
4th	0,009	0,013	0,013	0,032	0,044	0,045	Three Phase	4,000
5th	0,069	0,027	0,056	0,235	0,093	0,191	Three Phase	10,700
6th	0,012	0,010	0,011	0,040	0,035	0,038	Three Phase	2,667
7th	0,044	0,074	0,062	0,151	0,253	0,213	Three Phase	7,200
8th	0,008	0,010	0,009	0,026	0,034	0,032	Three Phase	2,000
9th	0,045	0,025	0,026	0,155	0,085	0,090	Three Phase	3,800
10th	0,005	0,005	0,007	0,017	0,019	0,023	Three Phase	1,600
11th	0,024	0,061	0,074	0,083	0,210	0,255	Three Phase	3,100
12th	0,006	0,004	0,006	0,022	0,014	0,020	Three Phase	1,333
13th	0,054	0,023	0,051	0,184	0,079	0,174	Three Phase	2,000
14th	0,005	0,005	0,007	0,018	0,018	0,024	Three Phase	8,000
15th	0,011	0,024	0,035	0,039	0,082	0,120	Three Phase	N/A
16th	0,004	0,006	0,004	0,015	0,021	0,014	Three Phase	N/A
17th	0,026	0,029	0,049	0,089	0,099	0,169	Three Phase	N/A
18th	0,005	0,005	0,003	0,016	0,017	0,011	Three Phase	N/A
19th	0,033	0,020	0,043	0,113	0,068	0,147	Three Phase	N/A
20th	0,003	0,005	0,004	0,011	0,016	0,014	Three Phase	N/A
21th	0,014	0,008	0,022	0,048	0,028	0,077	Three Phase	N/A
22th	0,004	0,004	0,003	0,013	0,015	0,011	Three Phase	N/A
23th	0,009	0,027	0,029	0,031	0,093	0,101	Three Phase	N/A
24th	0,003	0,003	0,004	0,011	0,011	0,012	Three Phase	N/A
25th	0,022	0,012	0,027	0,077	0,041	0,094	Three Phase	N/A
26th	0,004	0,004	0,003	0,012	0,014	0,010	Three Phase	N/A
27th	0,008	0,009	0,018	0,026	0,031	0,061	Three Phase	N/A
28th	0,003	0,003	0,003	0,011	0,012	0,009	Three Phase	N/A
29th	0,012	0,020	0,023	0,039	0,067	0,079	Three Phase	N/A
30th	0,003	0,003	0,003	0,009	0,012	0,009	Three Phase	N/A
31th	0,021	0,011	0,023	0,072	0,038	0,078	Three Phase	N/A
32th	0,003	0,003	0,003	0,009	0,011	0,009	Three Phase	N/A
33th	0,006	0,006	0,012	0,022	0,021	0,042	Three Phase	N/A
34th	0,004	0,004	0,004	0,012	0,013	0,012	Three Phase	N/A
35th	0,010	0,018	0,019	0,034	0,061	0,065	Three Phase	N/A
36th	0,003	0,003	0,003	0,010	0,011	0,009	Three Phase	N/A
37th	0,016	0,009	0,018	0,053	0,032	0,061	Three Phase	N/A
38th	0,002	0,003	0,002	0,009	0,009	0,009	Three Phase	N/A
39th	0,004	0,007	0,010	0,015	0,023	0,035	Three Phase	N/A
40th	0,002	0,002	0,002	0,009	0,008	0,008	Three Phase	N/A

4.8		TABLE: Current harmonics emission test						P	
Model: SOFAR 33000TL-G2									
Normal ambient (EN 61000-3-12) Output power 33%									
Watts(kW)				3,579/3,557/3,556					
Vrms(V)				230,19/229,55/230,05					
Arms(A)				15,552/15,495/15,461					
Frequency(Hz)				50,00					
THD* (33% output power)				0,908%/0,892%/0,776%					
Harmonics	Current Magnitude (A)			% of Fundamental			Phase	Harmonic Current Limits (%)	
	L1	L2	L3	L1	L2	L3			
1st	15,552	15,495	15,461	99,996	99,996	99,997	Three Phase	--	
2nd	0,029	0,015	0,027	0,186	0,099	0,173	Three Phase	8,000	
3rd	0,037	0,046	0,063	0,235	0,297	0,408	Three Phase	21,600	
4th	0,030	0,011	0,026	0,193	0,071	0,170	Three Phase	4,000	
5th	0,071	0,059	0,025	0,456	0,379	0,164	Three Phase	10,700	
6th	0,026	0,010	0,022	0,167	0,064	0,145	Three Phase	2,667	
7th	0,055	0,064	0,034	0,353	0,413	0,221	Three Phase	7,200	
8th	0,018	0,010	0,013	0,119	0,064	0,086	Three Phase	2,000	
9th	0,025	0,033	0,021	0,162	0,216	0,137	Three Phase	3,800	
10th	0,011	0,011	0,010	0,068	0,069	0,063	Three Phase	1,600	
11th	0,027	0,051	0,030	0,175	0,328	0,192	Three Phase	3,100	
12th	0,009	0,007	0,007	0,058	0,046	0,047	Three Phase	1,333	
13th	0,038	0,028	0,013	0,246	0,184	0,083	Three Phase	2,000	
14th	0,009	0,008	0,008	0,057	0,050	0,055	Three Phase	8,000	
15th	0,012	0,026	0,024	0,077	0,170	0,154	Three Phase	N/A	
16th	0,009	0,007	0,007	0,057	0,048	0,046	Three Phase	N/A	
17th	0,008	0,016	0,018	0,050	0,103	0,114	Three Phase	N/A	
18th	0,007	0,007	0,006	0,048	0,043	0,041	Three Phase	N/A	
19th	0,015	0,008	0,014	0,096	0,050	0,094	Three Phase	N/A	
20th	0,008	0,007	0,006	0,050	0,044	0,042	Three Phase	N/A	
21th	0,010	0,010	0,021	0,067	0,063	0,135	Three Phase	N/A	
22th	0,007	0,006	0,006	0,047	0,042	0,039	Three Phase	N/A	
23th	0,009	0,011	0,012	0,055	0,069	0,075	Three Phase	N/A	
24th	0,007	0,007	0,006	0,048	0,043	0,041	Three Phase	N/A	
25th	0,010	0,008	0,011	0,063	0,050	0,068	Three Phase	N/A	
26th	0,007	0,007	0,007	0,048	0,043	0,043	Three Phase	N/A	
27th	0,008	0,012	0,010	0,050	0,078	0,065	Three Phase	N/A	
28th	0,007	0,006	0,006	0,047	0,042	0,039	Three Phase	N/A	
29th	0,010	0,007	0,009	0,066	0,045	0,058	Three Phase	N/A	
30th	0,007	0,007	0,006	0,046	0,042	0,038	Three Phase	N/A	
31th	0,008	0,009	0,009	0,050	0,059	0,061	Three Phase	N/A	
32th	0,007	0,006	0,006	0,047	0,042	0,041	Three Phase	N/A	
33th	0,007	0,007	0,010	0,046	0,048	0,066	Three Phase	N/A	
34th	0,007	0,007	0,006	0,048	0,042	0,039	Three Phase	N/A	
35th	0,010	0,007	0,008	0,064	0,048	0,052	Three Phase	N/A	
36th	0,008	0,007	0,006	0,048	0,044	0,040	Three Phase	N/A	
37th	0,010	0,009	0,012	0,063	0,055	0,076	Three Phase	N/A	
38th	0,008	0,007	0,006	0,049	0,044	0,040	Three Phase	N/A	
39th	0,007	0,009	0,007	0,046	0,057	0,048	Three Phase	N/A	
40th	0,007	0,006	0,006	0,047	0,041	0,038	Three Phase	N/A	

4.8		TABLE: Current harmonics emission test						P	
Model: SOFAR 33000TL-G2									
Normal ambient (EN 61000-3-12)									
Output power 66%									
Watts(kW)				7,289/7,242/7,249					
Vrms(V)				230,31/229,72/230,20					
Arms(A)				31,652/31,528/31,495					
Frequency(Hz)				50,00					
THD* (66% output power)				0,622%/0,592%/0,764%					
Harmonics	Current Magnitude (A)			% of Fundamental			Phase	Harmonic Current Limits (%)	
	L1	L2	L3	L1	L2	L3			
1st	31,652	31,528	31,494	99,998	99,998	99,997	Three Phase	--	
2nd	0,036	0,029	0,031	0,114	0,092	0,098	Three Phase	8,000	
3rd	0,053	0,041	0,097	0,167	0,131	0,307	Three Phase	21,600	
4th	0,037	0,015	0,032	0,115	0,048	0,101	Three Phase	4,000	
5th	0,093	0,055	0,098	0,294	0,176	0,311	Three Phase	10,700	
6th	0,025	0,011	0,024	0,078	0,036	0,077	Three Phase	2,667	
7th	0,082	0,111	0,093	0,259	0,351	0,297	Three Phase	7,200	
8th	0,018	0,014	0,016	0,057	0,043	0,050	Three Phase	2,000	
9th	0,059	0,035	0,026	0,187	0,110	0,082	Three Phase	3,800	
10th	0,011	0,012	0,010	0,036	0,039	0,031	Three Phase	1,600	
11th	0,029	0,079	0,092	0,090	0,252	0,293	Three Phase	3,100	
12th	0,011	0,009	0,007	0,035	0,027	0,022	Three Phase	1,333	
13th	0,061	0,023	0,060	0,191	0,074	0,190	Three Phase	2,000	
14th	0,007	0,010	0,010	0,024	0,031	0,032	Three Phase	8,000	
15th	0,024	0,017	0,039	0,076	0,055	0,125	Three Phase	N/A	
16th	0,009	0,009	0,007	0,030	0,029	0,023	Three Phase	N/A	
17th	0,026	0,038	0,051	0,083	0,121	0,161	Three Phase	N/A	
18th	0,008	0,007	0,006	0,024	0,024	0,020	Three Phase	N/A	
19th	0,033	0,028	0,045	0,104	0,087	0,144	Three Phase	N/A	
20th	0,008	0,008	0,006	0,025	0,026	0,020	Three Phase	N/A	
21th	0,020	0,008	0,025	0,063	0,025	0,080	Three Phase	N/A	
22th	0,008	0,007	0,006	0,024	0,024	0,019	Three Phase	N/A	
23th	0,014	0,033	0,033	0,045	0,104	0,105	Three Phase	N/A	
24th	0,007	0,007	0,006	0,023	0,022	0,018	Three Phase	N/A	
25th	0,023	0,014	0,030	0,074	0,046	0,096	Three Phase	N/A	
26th	0,007	0,007	0,006	0,023	0,023	0,019	Three Phase	N/A	
27th	0,013	0,010	0,019	0,040	0,030	0,060	Three Phase	N/A	
28th	0,007	0,007	0,005	0,023	0,021	0,017	Three Phase	N/A	
29th	0,011	0,020	0,023	0,035	0,063	0,073	Three Phase	N/A	
30th	0,007	0,006	0,005	0,021	0,019	0,017	Three Phase	N/A	
31th	0,021	0,013	0,024	0,066	0,041	0,077	Three Phase	N/A	
32th	0,007	0,006	0,006	0,023	0,021	0,018	Three Phase	N/A	
33th	0,010	0,008	0,014	0,030	0,026	0,045	Three Phase	N/A	
34th	0,007	0,006	0,005	0,022	0,020	0,017	Three Phase	N/A	
35th	0,011	0,020	0,019	0,035	0,065	0,061	Three Phase	N/A	
36th	0,007	0,007	0,006	0,023	0,022	0,019	Three Phase	N/A	
37th	0,014	0,009	0,017	0,045	0,030	0,052	Three Phase	N/A	
38th	0,007	0,007	0,006	0,022	0,021	0,018	Three Phase	N/A	
39th	0,008	0,008	0,010	0,025	0,027	0,031	Three Phase	N/A	
40th	0,007	0,006	0,005	0,022	0,020	0,017	Three Phase	N/A	

4.8		TABLE: Current harmonics emission test						P	
Model: SOFAR 33000TL-G2									
Normal ambient (EN 61000-3-12)									
Output power 100%									
Watts(kW)				11,043/10,972/10,980					
Vrms(V)				230,31/229,69/230,10					
Arms(A)				47,951/47,773/47,724					
Frequency(Hz)				50,00					
THD* (100% output power)				0,633%/0,624%/0,567%					
Harmonics	Current Magnitude (A)			% of Fundamental			Phase	Harmonic Current Limits (%)	
	L1	L2	L3	L1	L2	L3			
1st	47,950	47,772	47,724	99,998	99,998	99,998	Three Phase	--	
2nd	0,124	0,087	0,076	0,258	0,181	0,158	Three Phase	8,000	
3rd	0,057	0,054	0,094	0,120	0,113	0,197	Three Phase	21,800	
4th	0,066	0,047	0,037	0,138	0,099	0,077	Three Phase	4,000	
5th	0,060	0,075	0,066	0,124	0,157	0,139	Three Phase	10,700	
6th	0,043	0,013	0,035	0,090	0,028	0,073	Three Phase	2,667	
7th	0,178	0,198	0,114	0,371	0,415	0,240	Three Phase	7,200	
8th	0,052	0,017	0,042	0,108	0,036	0,088	Three Phase	2,000	
9th	0,095	0,077	0,018	0,198	0,161	0,038	Three Phase	3,800	
10th	0,027	0,011	0,023	0,056	0,024	0,047	Three Phase	1,800	
11th	0,058	0,112	0,126	0,121	0,235	0,264	Three Phase	3,100	
12th	0,019	0,010	0,012	0,039	0,021	0,025	Three Phase	1,333	
13th	0,070	0,032	0,069	0,147	0,067	0,145	Three Phase	2,000	
14th	0,014	0,013	0,007	0,030	0,027	0,014	Three Phase	8,000	
15th	0,024	0,025	0,026	0,051	0,052	0,055	Three Phase	N/A	
16th	0,017	0,012	0,008	0,035	0,025	0,016	Three Phase	N/A	
17th	0,022	0,038	0,046	0,046	0,080	0,097	Three Phase	N/A	
18th	0,014	0,011	0,006	0,029	0,023	0,012	Three Phase	N/A	
19th	0,039	0,038	0,056	0,081	0,079	0,118	Three Phase	N/A	
20th	0,009	0,007	0,007	0,018	0,015	0,014	Three Phase	N/A	
21th	0,028	0,009	0,018	0,057	0,019	0,038	Three Phase	N/A	
22th	0,007	0,006	0,007	0,015	0,012	0,014	Three Phase	N/A	
23th	0,024	0,039	0,034	0,049	0,082	0,072	Three Phase	N/A	
24th	0,007	0,006	0,005	0,014	0,012	0,011	Three Phase	N/A	
25th	0,023	0,018	0,029	0,047	0,037	0,061	Three Phase	N/A	
26th	0,006	0,006	0,005	0,014	0,012	0,011	Three Phase	N/A	
27th	0,014	0,006	0,017	0,029	0,013	0,036	Three Phase	N/A	
28th	0,007	0,006	0,005	0,014	0,013	0,011	Three Phase	N/A	
29th	0,014	0,023	0,023	0,029	0,049	0,048	Three Phase	N/A	
30th	0,006	0,006	0,005	0,013	0,012	0,011	Three Phase	N/A	
31th	0,024	0,020	0,028	0,049	0,042	0,058	Three Phase	N/A	
32th	0,006	0,006	0,005	0,013	0,012	0,010	Three Phase	N/A	
33th	0,010	0,006	0,010	0,021	0,013	0,020	Three Phase	N/A	
34th	0,006	0,006	0,005	0,013	0,012	0,010	Three Phase	N/A	
35th	0,018	0,027	0,025	0,038	0,056	0,051	Three Phase	N/A	
36th	0,006	0,006	0,005	0,013	0,012	0,010	Three Phase	N/A	
37th	0,016	0,012	0,017	0,034	0,026	0,036	Three Phase	N/A	
38th	0,006	0,005	0,005	0,013	0,011	0,010	Three Phase	N/A	
39th	0,007	0,006	0,008	0,015	0,012	0,016	Three Phase	N/A	
40th	0,006	0,005	0,005	0,013	0,011	0,010	Three Phase	N/A	

4.8	TABLE: Flicker				P
Flicker measurement					
According to EN 61000-3-3/EN 61000-3-11					
Model: SOFAR 33000TL-G2					
Value	P _{st}	P _{It}	d _c	d _{max}	
Limit	≤ 1	≤ 0.65	≤ 3.30%	4%	
Test value	0.14	0.14	0.03	0.20	
Test: SOFAR 33000TL-G2					
	No.	dc[%]	dmax[%]	d(t)[ms]	Pst
	1	0.02	0.17	0.00	0.13
	2	0.01	0.18	0.00	0.13
	3	0.01	0.19	0.00	0.14
	4	0.03	0.18	0.00	0.13
	5	0.02	0.19	0.00	0.13
	6	0.00	0.12	0.00	0.13
	7	0.01	0.20	0.00	0.16
	8	0.02	0.18	0.00	0.14
	9	0.02	0.20	0.00	0.16
	10	0.03	0.20	0.00	0.16
	11	0.02	0.20	0.00	0.14
	12	0.02	0.18	0.00	0.14
					P _{It}
					0.14
Model: SOFAR 20000TL-G2					
Value	P _{st}	P _{It}	d _c	d _{max}	
Limit	≤ 1	≤ 0.65	≤ 3.30%	4%	
Test value	0.11	0.11	0.06	0.11	
Test: SOFAR 20000TL-G2					
	No.	dc[%]	dmax[%]	d(t)[ms]	Pst
	1	0.06	0.11	0.00	0.11
	2	0.00	0.00	0.00	0.11
	3	0.00	0.00	0.00	0.11
	4	0.00	0.00	0.00	0.11
	5	0.01	0.10	0.00	0.11
	6	0.00	0.00	0.00	0.11
	7	0.00	0.00	0.00	0.11
	8	0.00	0.00	0.00	0.11
	9	0.00	0.00	0.00	0.11
	10	0.00	0.00	0.00	0.11
	11	0.00	0.00	0.00	0.11
	12	0.00	0.00	0.00	0.11
					P _{It}
					0.11

4.8	TABLE: DC injection						P
Model: SOFAR 20000TL-G2							
Power level	DC current [A]			% of nominal current			Limit
	R	S	T	R	S	T	
33%	-0.088	-0.053	-0.068	-0.297	-0.183	-0.235	±0.5%
66%	-0.087	-0.054	-0.076	-0.300	-0.186	-0.262	±0.5%
100%	-0.074	-0.054	-0.063	-0.255	-0.188	-0.217	±0.5%

4.8	TABLE: DC injection						P
Model: SOFAR 33000TL-G2							
Power level	DC current [A]			% of nominal current			Limit
	R	S	T	R	S	T	
33%	0.078	0.031	-0.073	0.163	0.065	-0.153	±0.5%
66%	0.060	-0.030	-0.067	0.130	-0.063	-0.140	±0.5%
100%	0.046	-0.062	-0.077	0.096	-0.130	-0.161	±0.5%

4.9.3		Table: Interface protection				P
Undervoltage threshold stage 1 [27 <]					Yes	No
Adjustment range						
Trip value Config. from 0.2 to 1 Un (0.01 Un steps)					Yes	--
Trip time Config. from 0.1 to 100 s (0.1 s steps)					Yes	--
Parameter	Settings	Test 1	Test 2	Test 3	Limits	
Trip value L1[V]	46	44.58	44.90	45.00	46±2.3	
Trip time [s]	0.1	0.092	0.098	0.107	0.1±10%	
Trip value L2[V]	46	44.58	44.90	45.00	46±2.3	
Trip time [s]	0.1	0.095	0.096	0.099	0.1±10%	
Trip value L3[V]	46	44.86	44.91	44.99	46±2.3	
Trip time [s]	0.1	0.095	0.096	0.103	0.1±10%	
Trip value L1L2L3[V]	46	44.95	44.90	44.92	46±2.3	
Trip time [s]	0.1	0.098	0.095	0.097	0.1±10%	
Parameter	Settings	Test 1	Test 2	Test 3	Limits	
Trip value L1[V]	46	44.58	44.90	45.00	46±2.3	
Trip time [s]	100	100.2	100.4	100.5	100±10%	
Trip value L2[V]	46	44.58	44.90	45.00	46±2.3	
Trip time [s]	100	99.9	100.2	100.0	100±10%	
Trip value L3[V]	46	44.86	44.91	44.99	46±2.3	
Trip time [s]	100	99.6	100.2	100.5	100±10%	
Trip value L1L2L3[V]	46	44.95	44.90	44.92	46±2.3	
Trip time [s]	100	100.4	100.5	100.3	100±10%	

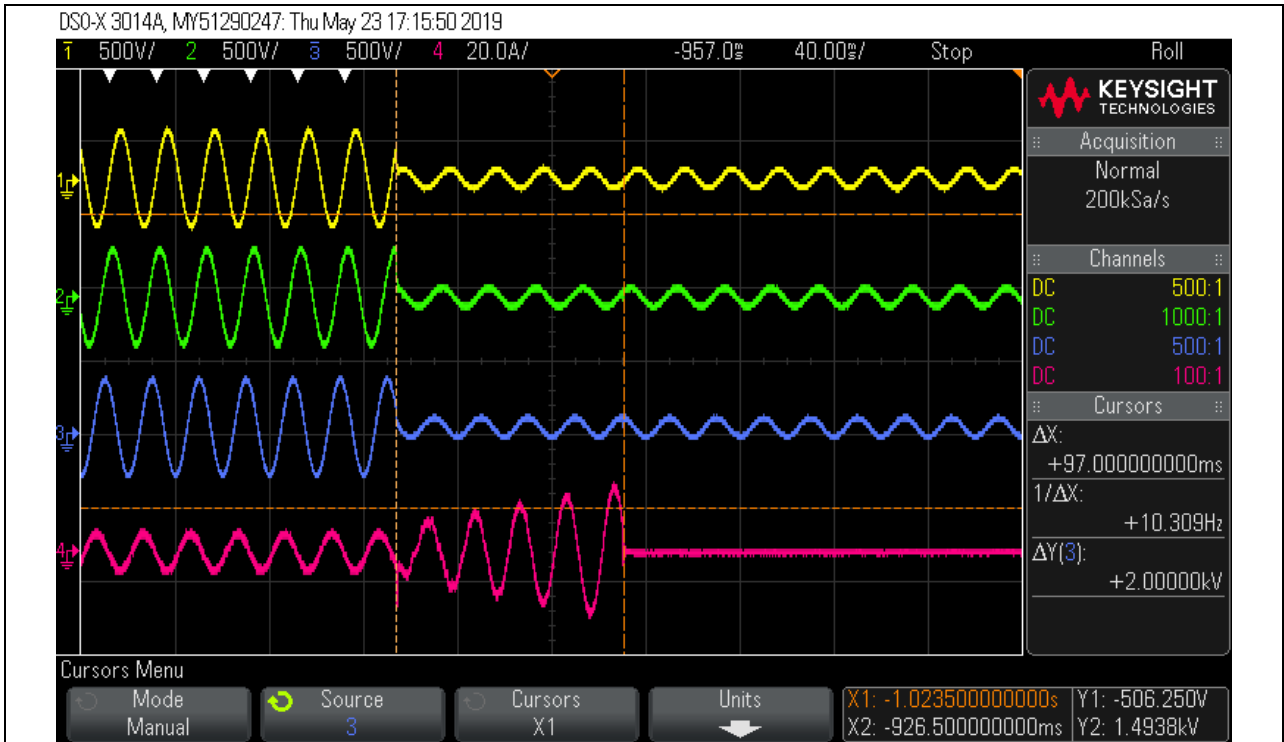

L1 L2 L3 Trip time (0.1s setting)

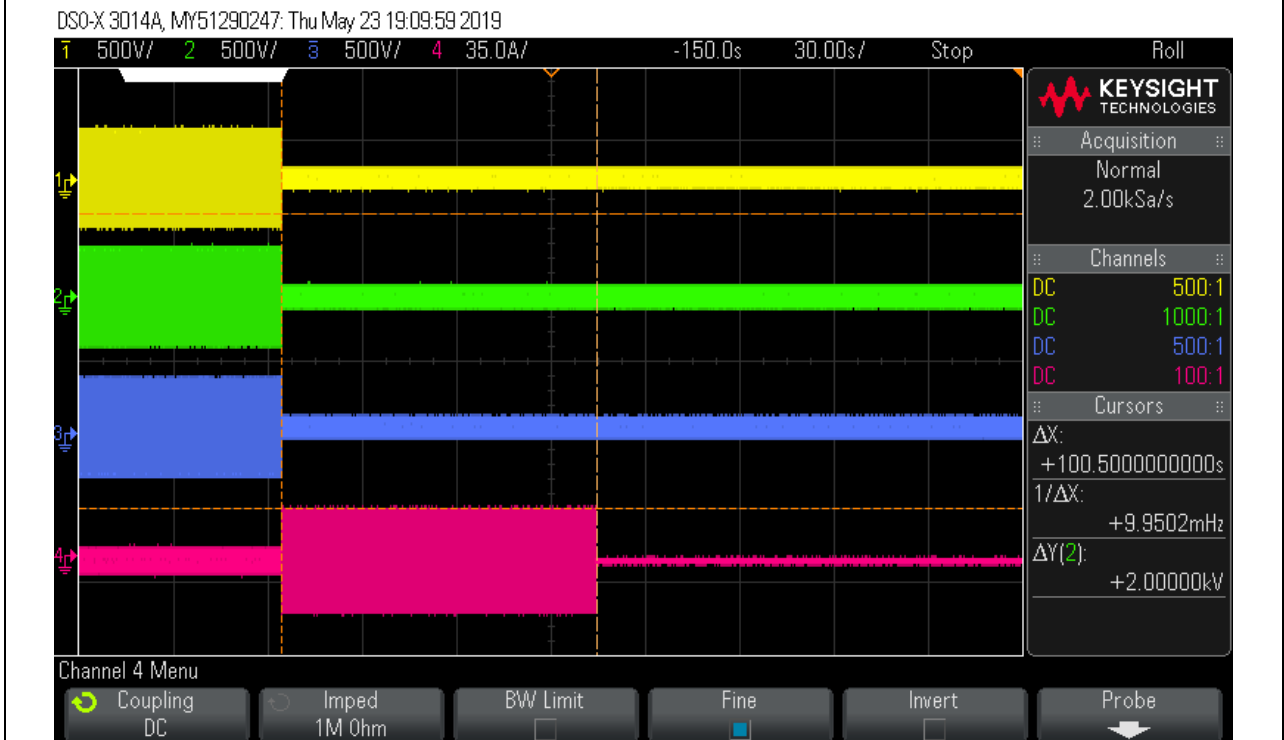

L1 L2 L3 Trip time (100s setting)

4.9.3		Table: Interface protection				P
Undervoltage threshold stage 2 [27 <<]					Yes	No
Adjustment range						
Trip value Config. from 0.2 to 1 Un (0.01 Un steps)					Yes	--
Trip time Config. from 0.1 to 5s (0.05 s steps)					Yes	--
Parameter	Settings	Test 1	Test 2	Test 3	Limits	
Trip value L1[V]	46	44.58	44.90	45.00	46±2.3	
Trip time [s]	0.1	0.099	0.101	0.103	0.1±10%	
Trip value L2[V]	46	44.58	44.90	45.00	46±2.3	
Trip time [s]	0.1	0.096	0.099	0.101	0.1±10%	
Trip value L3[V]	46	44.86	44.91	44.99	46±2.3	
Trip time [s]	0.1	0.093	0.094	0.096	0.1±10%	
Trip value L1L2L3[V]	46	44.95	44.90	44.92	46±2.3	
Trip time [s]	0.1	0.100	0.100	0.099	0.1±10%	
Parameter	Settings	Test 1	Test 2	Test 3	Limits	
Trip value L1[V]	46	44.58	44.90	45.00	46±2.3	
Trip time [s]	5	5.02	5.04	5.00	5±10%	
Trip value L2[V]	46	44.58	44.90	45.00	46±2.3	
Trip time [s]	5	5.01	5.02	5.02	5±10%	
Trip value L3[V]	46	44.86	44.91	44.99	46±2.3	
Trip time [s]	5	4.98	5.02	5.00	5±10%	
Trip value L1L2L3[V]	46	44.95	44.90	44.92	46±2.3	
Trip time [s]	5	5.02	5.03	5.00	5±10%	

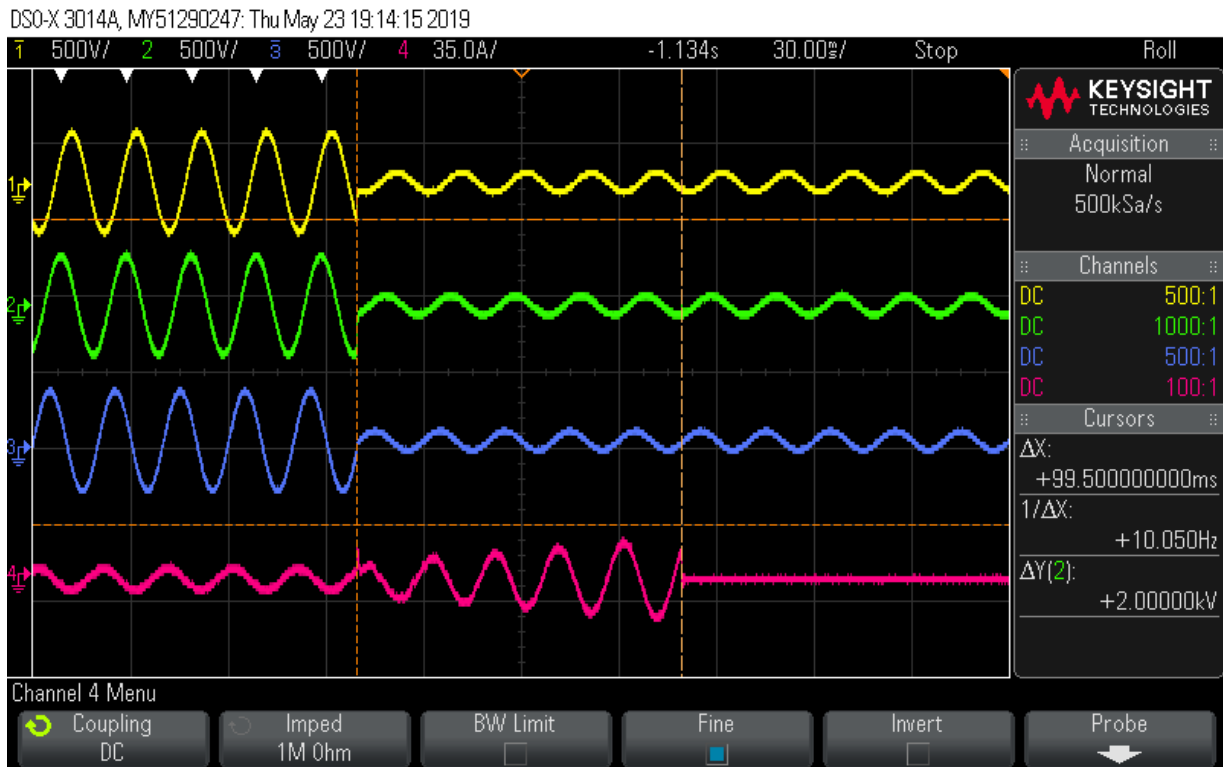

L1L2L3Trip time (0.1s setting)

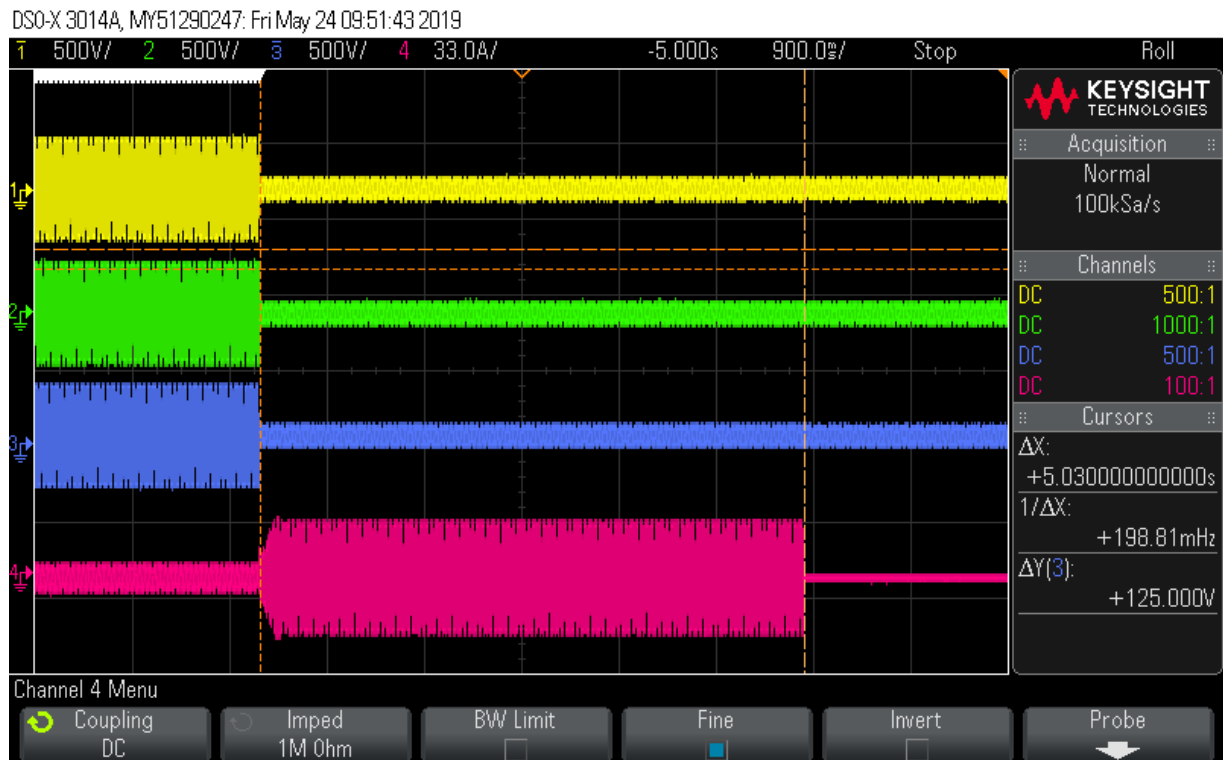

L1L2L3Trip time (5s setting)

4.9.3		Table: Interface protection				P
Overvoltage threshold stage 1 [59 >]					Yes	No
Adjustment range						
Trip value Config. from 1.0 to 1.2 Un (0.01 Un steps)					Yes	--
Trip time Config. from 0.1 to 100s (0.1 s steps)					Yes	--
Parameter	Settings	Test 1	Test 2	Test 3	Limits	
Trip value L1[V]	276	276.06	276.11	276.12	276±2.3	
Trip time [s]	0.1	0.098	0.101	0.104	0.1±10%	
Trip value L2[V]	276	276.47	276.51	276.58	276±2.3	
Trip time [s]	0.1	0.098	0.099	0.099	0.1±10%	
Trip value L3[V]	276	276.19	276.34	276.41	276±2.3	
Trip time [s]	0.1	0.095	0.095	0.104	0.1±10%	
Trip value L1L2L3[V]	276	276.28	276.33	276.38	276±2.3	
Trip time [s]	0.1	0.101	0.103	0.105	0.1±10%	
Parameter	Settings	Test 1	Test 2	Test 3	Limits	
Trip value L1[V]	276	276.06	276.11	276.12	276±2.3	
Trip time [s]	100	100.2	100.8	100.8	100±10%	
Trip value L2[V]	276	276.47	276.51	276.58	276±2.3	
Trip time [s]	100	100.4	100.6	100.8	100±10%	
Trip value L3[V]	276	276.19	276.34	276.41	276±2.3	
Trip time [s]	100	100.6	100.8	101.5	100±10%	
Trip value L1L2L3[V]	276	276.28	276.33	276.38	276±2.3	
Trip time [s]	100	100.2	100.4	100.5	100±10%	

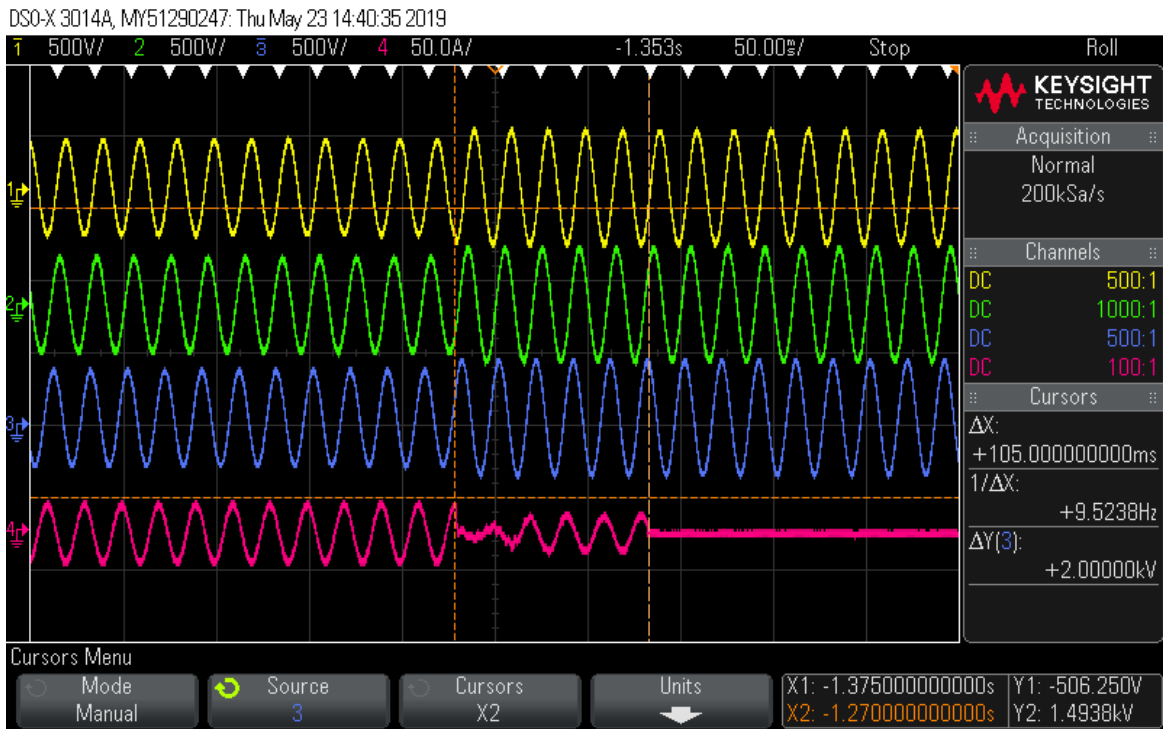

L1L2L3Trip time (0.1s setting)

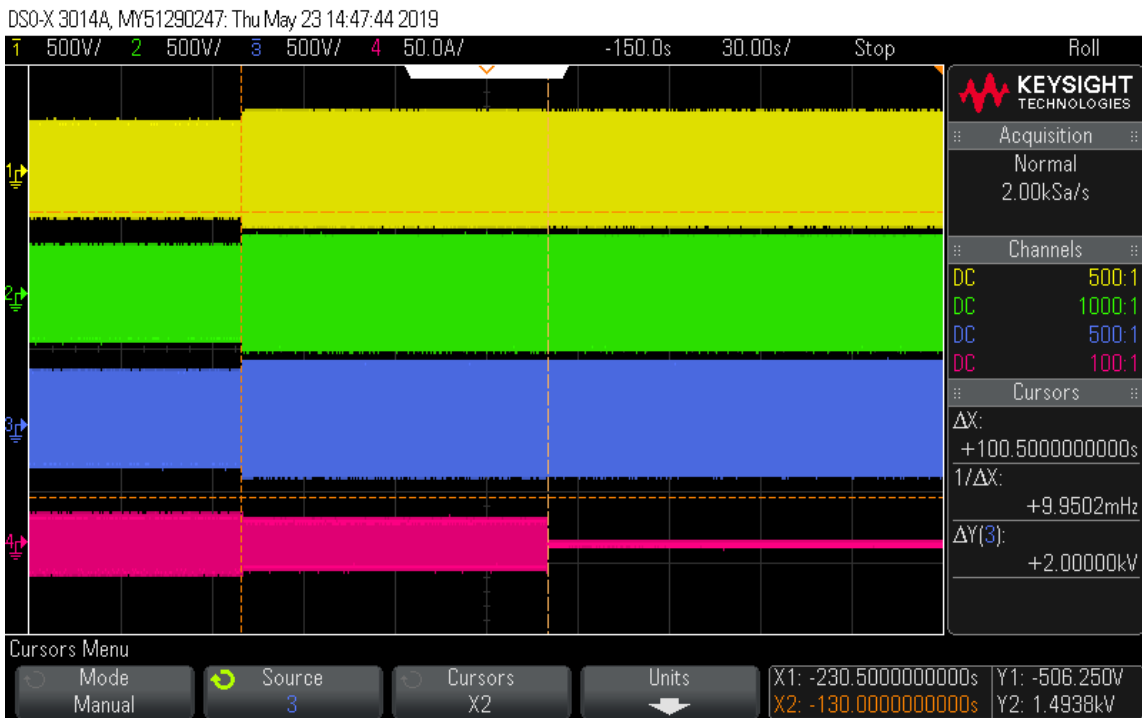

L1L2L3Trip time (100s setting)

4.9.3	Table: Interface protection					P
Overvoltage threshold stage 2 [59>>]					Yes	No
Adjustment range						
Trip value Config. from 1.0 to 1.3 Un (0.01 Un steps)					Yes	--
Trip time Config. from 0.1 to 5s (0.05 s steps)					Yes	--
Parameter	Settings	Test 1	Test 2	Test 3	Limits	
Trip value L1[V]	299	299.78	299.80	299.80	299±2.3	
Trip time [s]	0.1	0.093	0.093	0.098	0.1±10%	
Trip value L2[V]	299	299.74	299.98	300.04	299±2.3	
Trip time [s]	0.1	0.100	0.092	0.093	0.1±10%	
Trip value L3[V]	299	299.78	299.94	300.04	299±2.3	
Trip time [s]	0.1	0.102	0.104	0.107	0.1±10%	
Trip value L1L2L3[V]	299	299.07	299.11	299.16	299±2.3	
Trip time [s]	0.1	0.98	0.99	0.104	0.1±10%	
Parameter	Settings	Test 1	Test 2	Test 3	Limits	
Trip value L1[V]	299	299.78	299.80	299.80	299±2.3	
Trip time [s]	5	5.04	5.04	5.06	5±10%	
Trip value L2[V]	299	299.74	299.98	300.04	299±2.3	
Trip time [s]	5	5.21	5.22	5.26	5±10%	
Trip value L3[V]	299	299.78	299.94	300.04	299±2.3	
Trip time [s]	5	5.01	5.02	5.04	5±10%	
Trip value L1L2L3[V]	299	299.07	299.11	299.16	299±2.3	
Trip time [s]	5	5.03	5.04	5.06	5±10%	

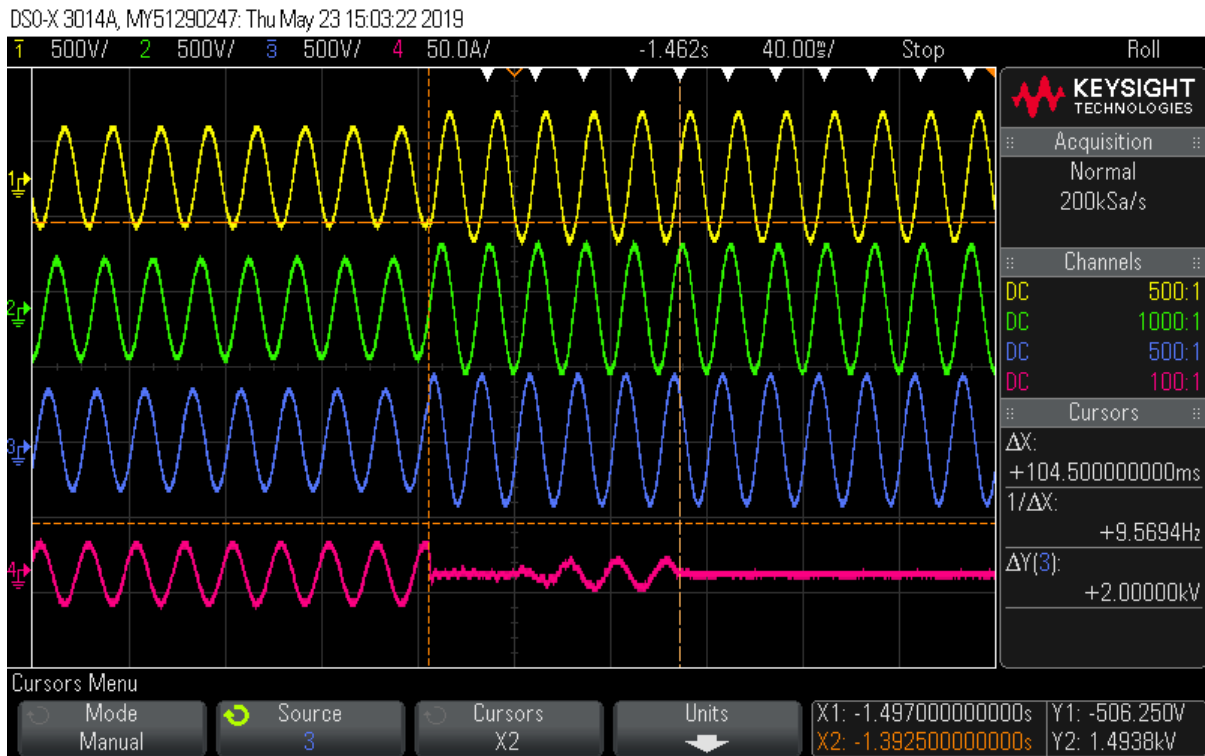

L1L2L3 Trip time (0.1s setting)

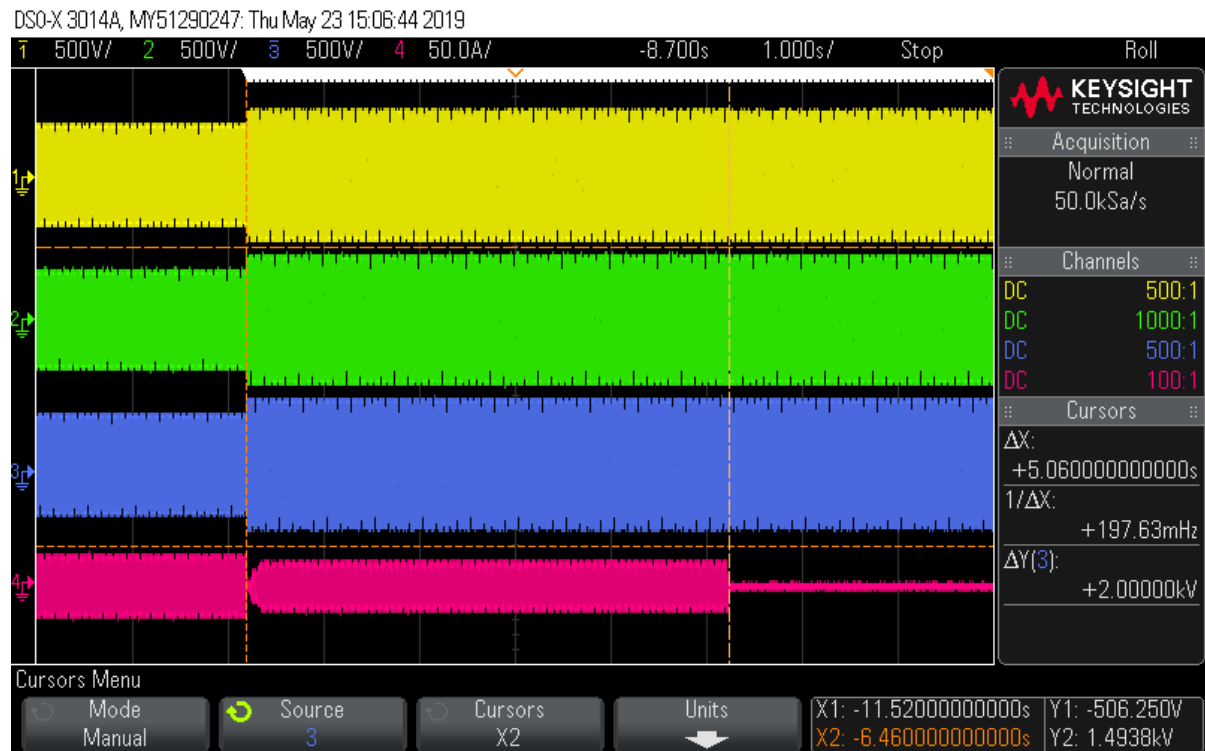

L1L2L3 Trip time (5s setting)

4.9.3		Table: Interface protection				P
Overvoltage 10 min mean protection					Yes	No
Adjustment range						
Trip value Config. from 1.0 to 1.15Un (0.01 Un steps)					Yes	--
Trip time Config ≤ 3s not adjustable Time delay setting = 0 ms					Yes	--
Parameter	Settings	Test 1	Test 2	Test 3	Limits	
Trip value L1[V]	253	252.60	252.66	252.66	253±2.3	
Trip time [s]	≤ 603s	491	496	496	≤ 603s	
Trip value L2[V]	253	253.09	253.13	253.13	253±2.3	
Trip time [s]	≤ 603s	503	504	504	≤ 603s	
Trip value L3[V]	253	253.29	253.47	253.48	253±2.3	
Trip time [s]	≤ 603s	505	507	507	≤ 603s	
Trip value L1L2L3[V]	253	252.75	252.79	252.79	253±2.3	
Trip time [s]	≤ 603s	497	485	485	≤ 603s	

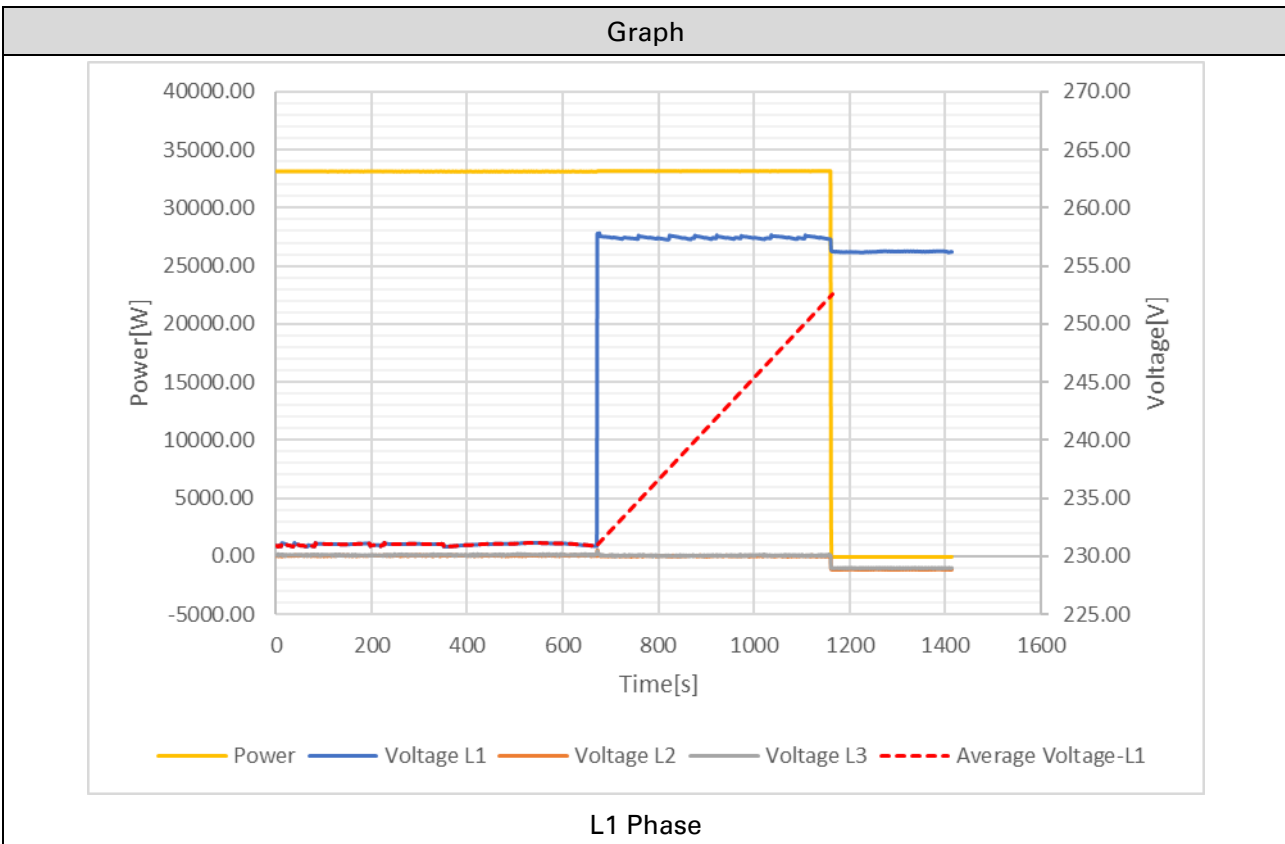

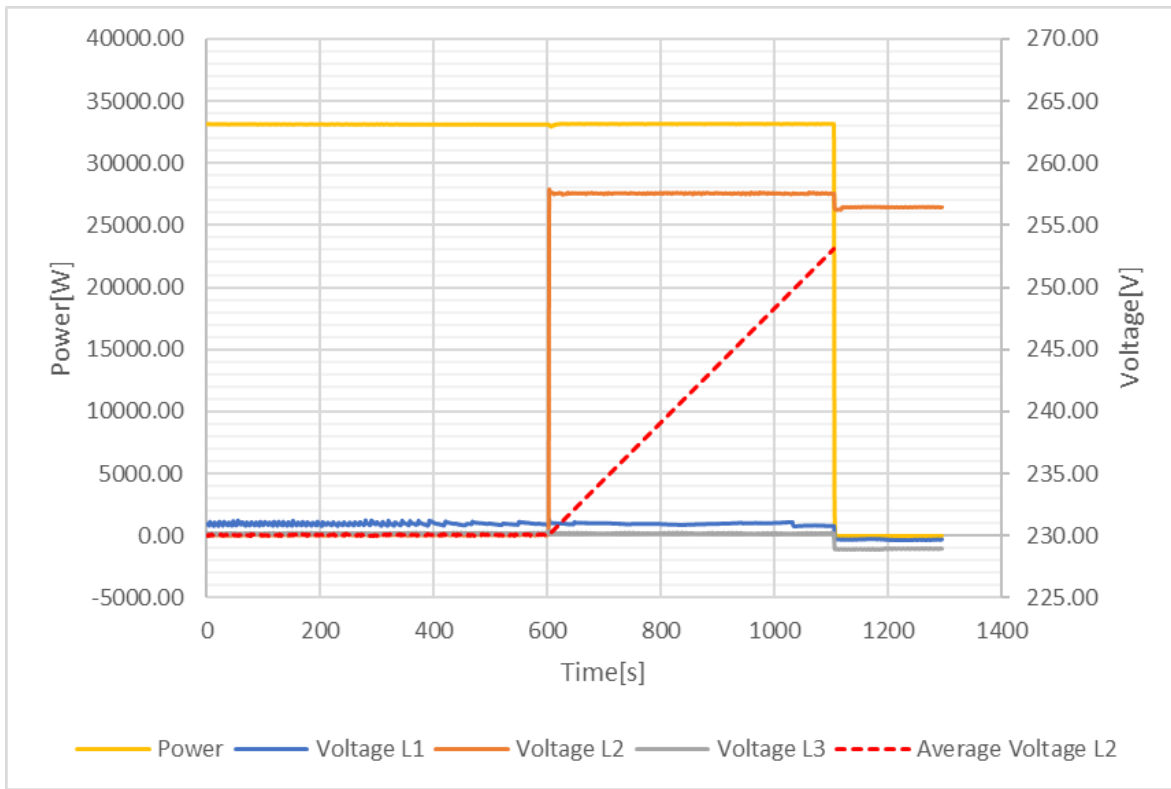

L2 phase

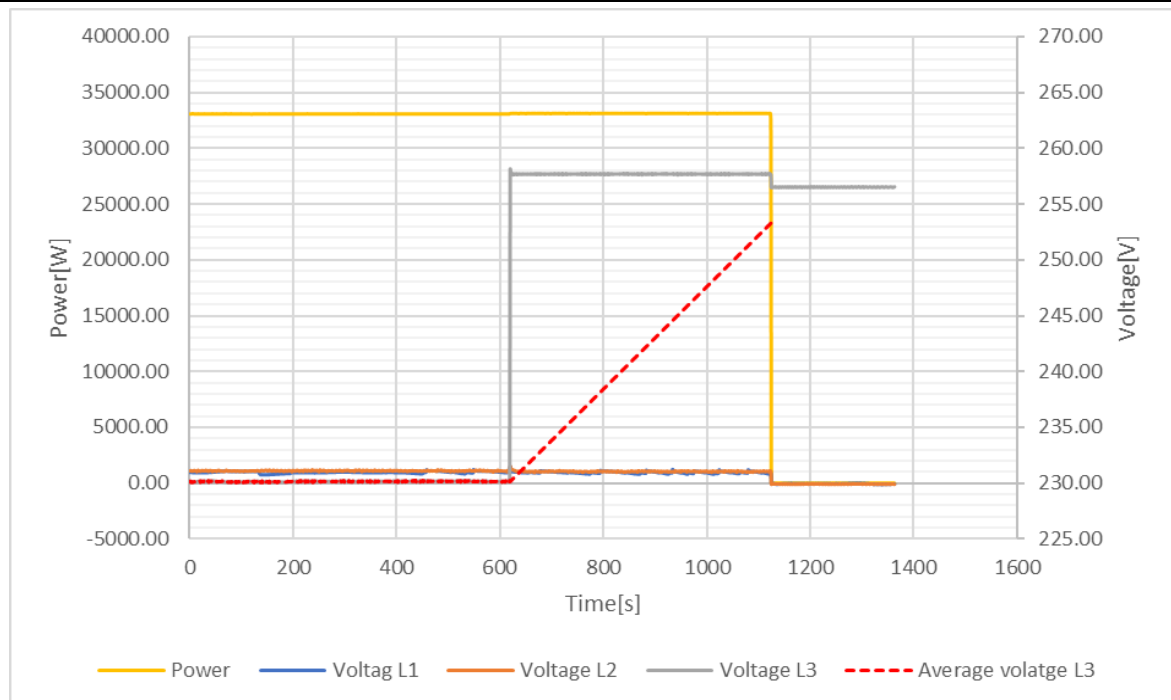

L3 phase

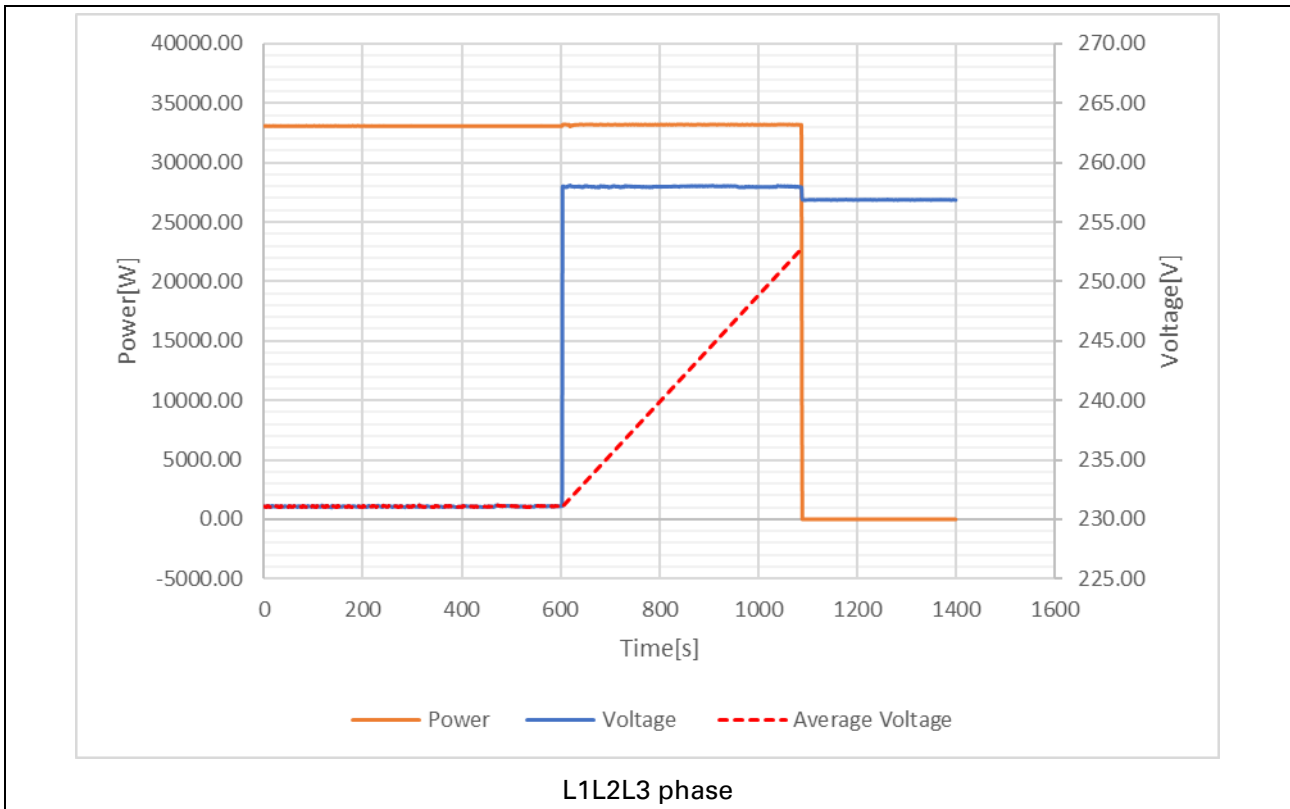

4.9.3	Table: Interface protection				P
Underfrequency threshold stage 1 [81 <] Adjustment range				Yes	No
Trip value Config. from 47.0 to 50.0Hz (0.1Hz steps)				Yes	--
Trip time Config. from 0.1 to 100s (0.1s steps)				Yes	--
it may be required to have the ability to activate and deactivate a stage by an external signal.				Yes	
This protection trips in the range from 0.2Un to 1.20Un.it is inhibited for input voltages of less than 20 % Un				Yes	
Parameter	Settings	Test 1	Test 2	Test 3	Limits
Trip value [Hz]	47.0	46.96	46.98	47.01	47.0±0.05
Trip time [s]	0.1	0.100	0.101	0.101	0.1±10%
Parameter	Settings	Test 1	Test 2	Test 3	Limits
Trip value [Hz]	47.0	46.96	46.98	47.01	47.0±0.05
Trip time [s]	100	100.8	100.0	101.5	100±10%

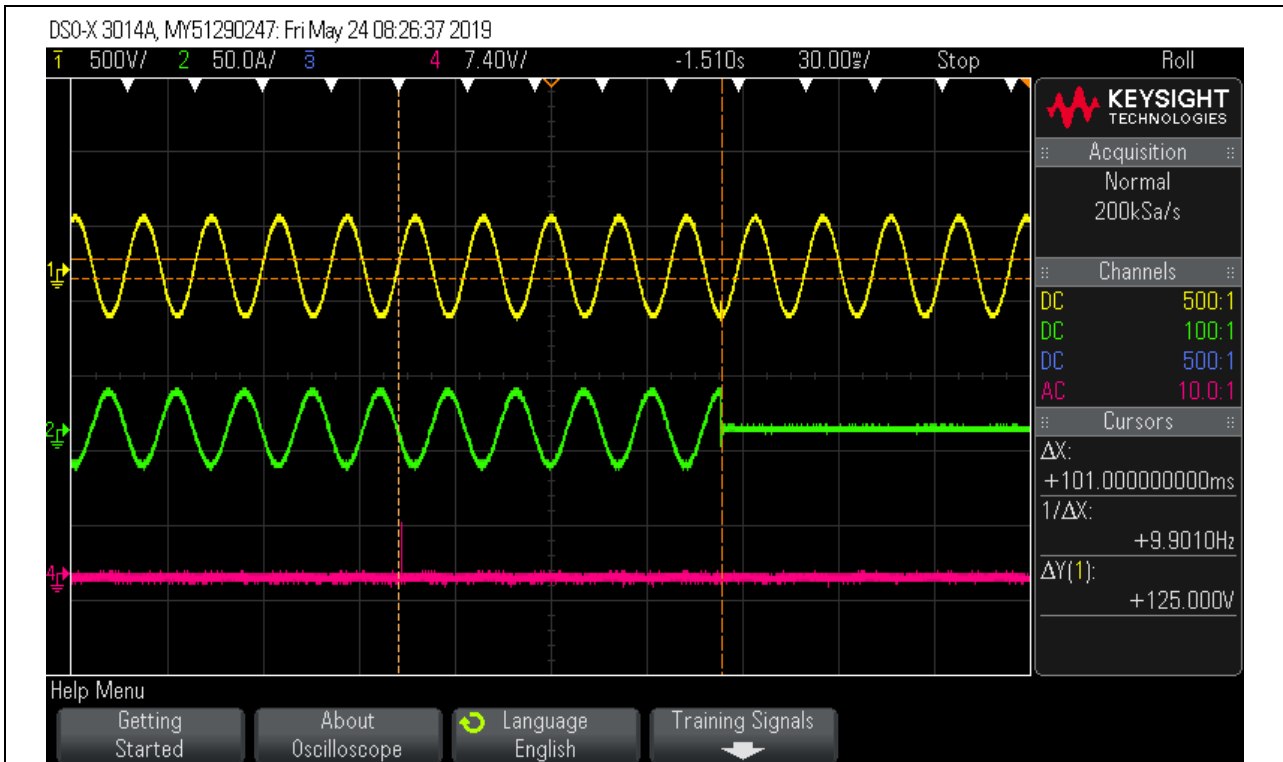

Trip time (0.1s setting)

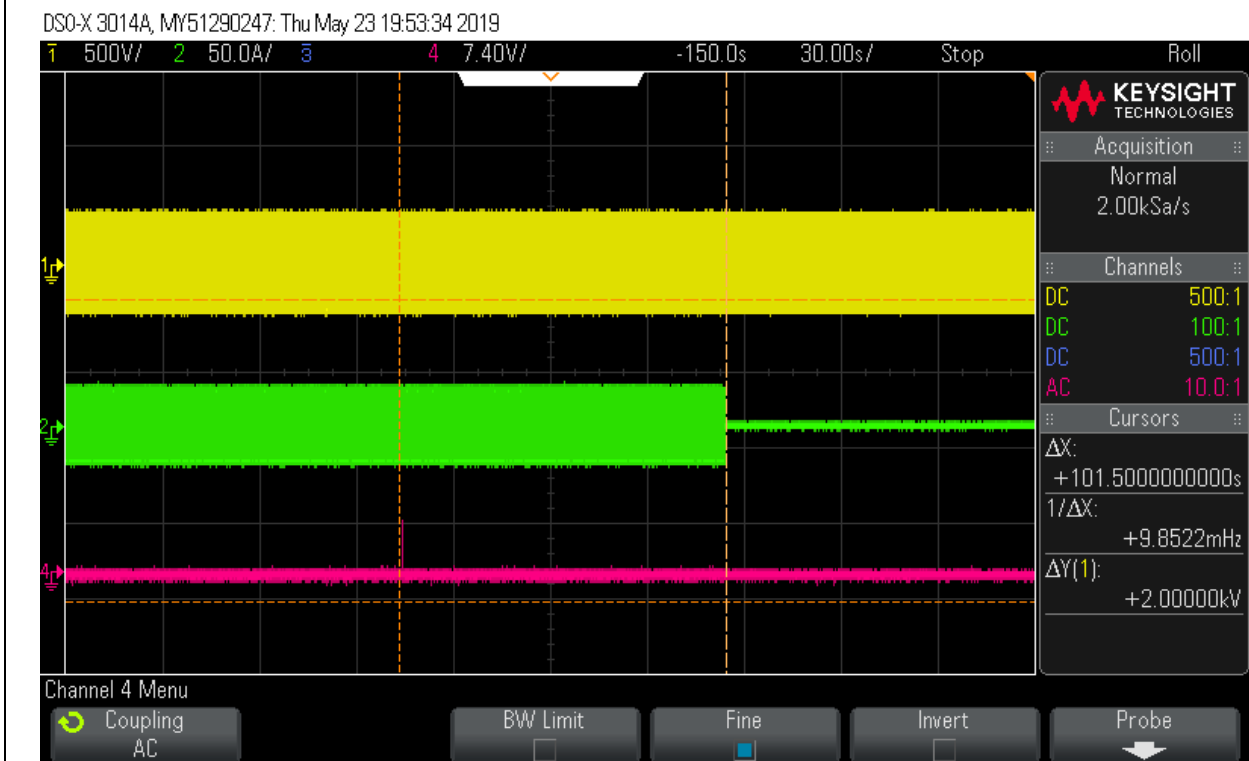

Trip time (100s setting)

4.9.3	Table: Interface protection				P
Underfrequency threshold stage 2 [81 <<] Adjustment range				Yes	No
Trip value Config. from 47.0 to 50.0Hz (0.1Hz steps)				Yes	--
Trip time Config. from 0.1 to 5s (0.05s steps)				Yes	--
it may be required to have the ability to activate and deactivate a stage by an external signal.				Yes	
This protection trips in the range from 0.2Un to 1.20Un.it is inhibited for input voltages of less than 20 % Un				Yes	
Parameter	Settings	Test 1	Test 2	Test 3	Limits
Trip value [Hz]	47.0	46.96	46.98	47.01	47.0±0.05
Trip time [s]	0.1	0.091	0.097	0.097	0.1±10%
Parameter	Settings	Test 1	Test 2	Test 3	Limits
Trip value [Hz]	47.0	46.96	46.98	47.01	47.0±0.05
Trip time [s]	5	5.03	5.03	5.06	5±10%

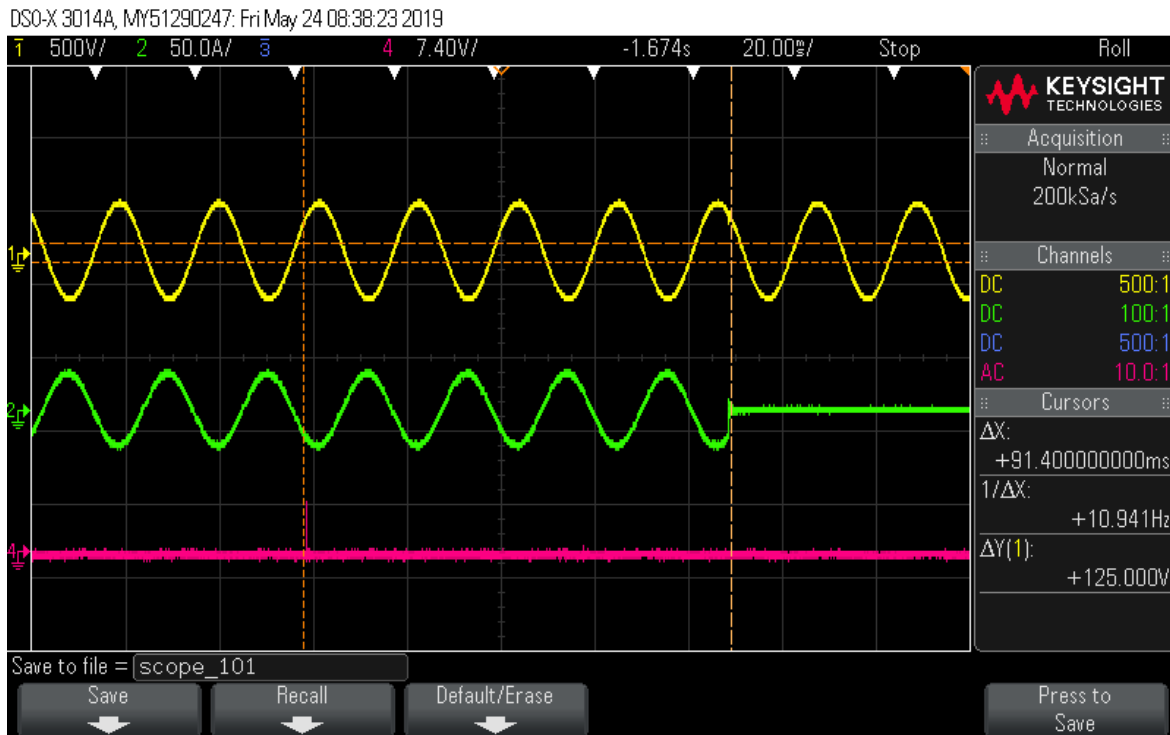

Trip time (0.1s setting)

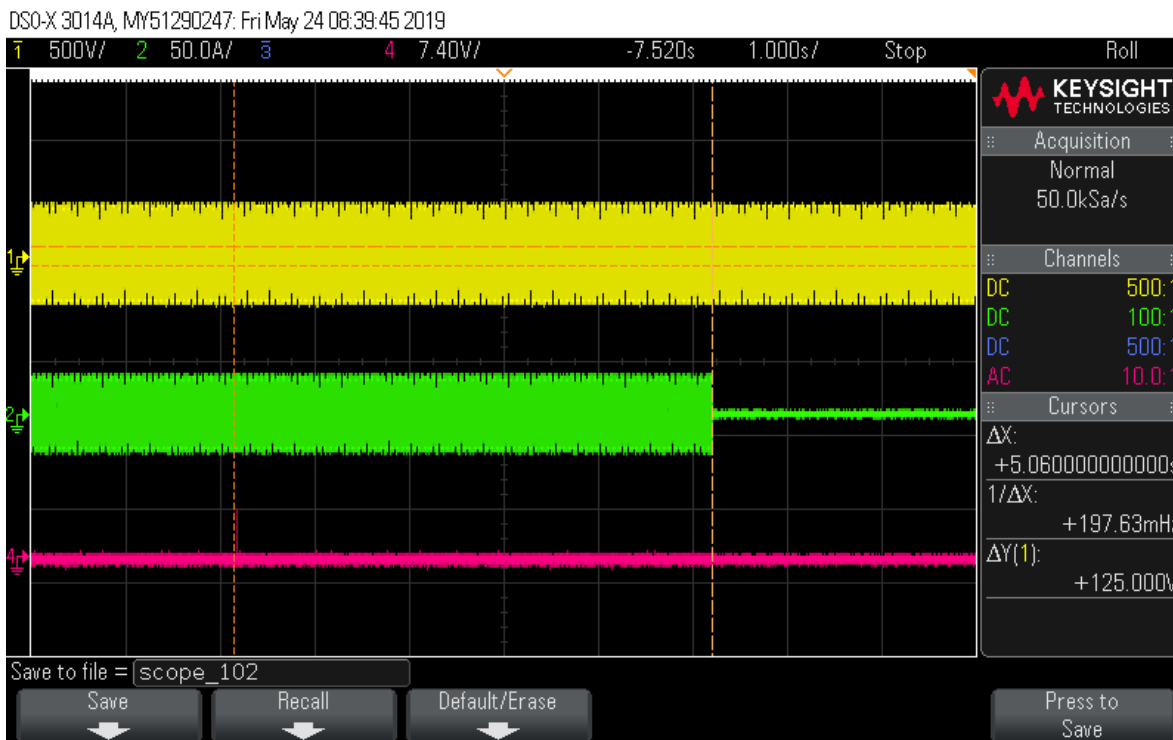

Trip time (5s setting)

4.9.3	Table: Interface protection				P
Overfrequency threshold stage 1 [81 >] Adjustment range				Yes	No
Trip value Config. from 50.0 to 52.0Hz (0.1Hz steps)				Yes	--
Trip time Config. from 0.1 to 100s (0.1s steps)				Yes	--
it may be required to have the ability to activate and deactivate a stage by an external signal.				Yes	
This protection trips in the range from 0.2Un to 1.20Un.it is inhibited for input voltages of less than 20 % Un				Yes	
Parameter	Settings	Test 1	Test 2	Test 3	Limits
Trip value [Hz]	52.0	52.02	52.03	52.04	52.0±0.05
Trip time [s]	0.1	0.096	0.105	0.106	0.1±10%
Parameter	Settings	Test 1	Test 2	Test 3	Limits
Trip value [Hz]	52.0	52.02	52.03	52.04	52.0±0.05
Trip time [s]	100	100.4	100.6	101.0	100±10%

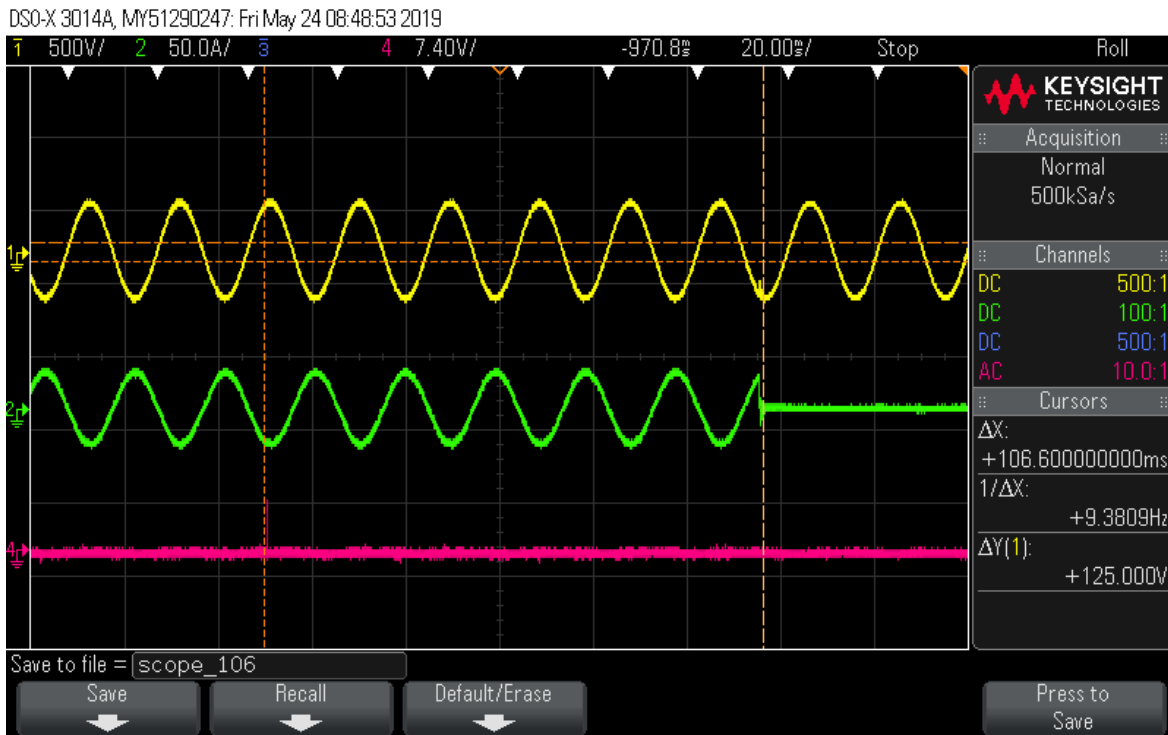

Trip time (0.1s setting)

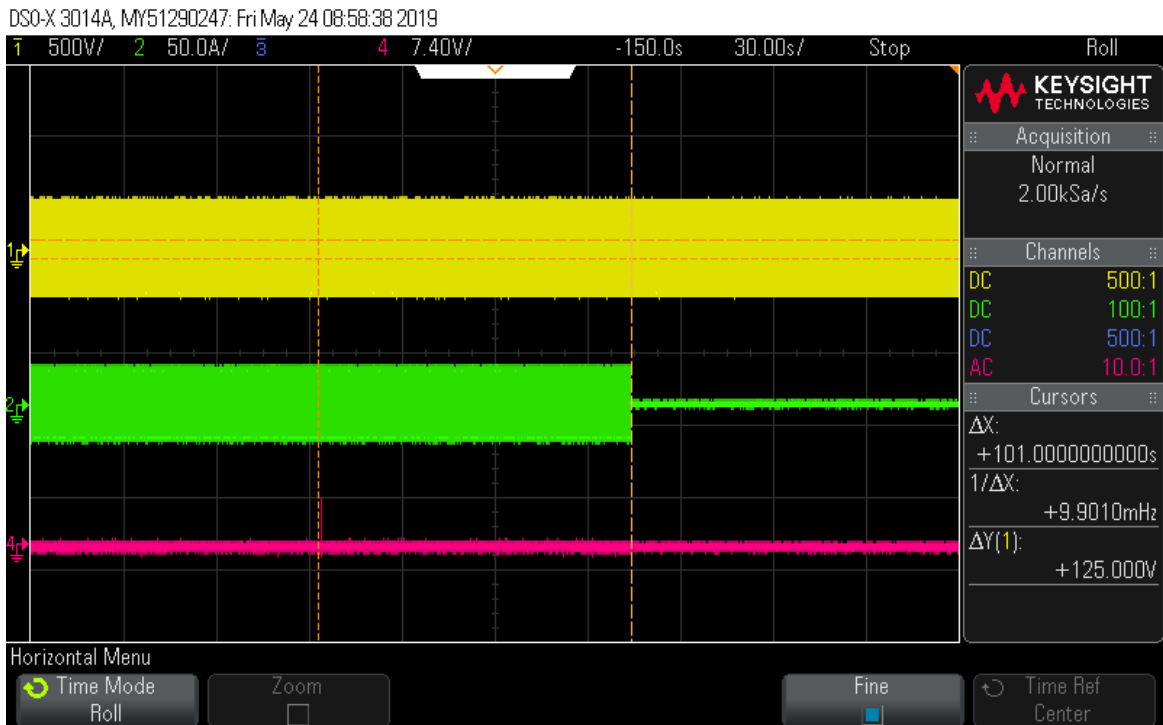

Trip time (100s setting)

4.9.3	Table: Interface protection				P
Overfrequency threshold stage 2 [81 >>]				Yes	No
Adjustment range					
Trip value Config. from 50.0 to 52.0Hz (0.1Hz steps)				Yes	--
Trip time Config. from 0.1 to 5s (0.05s steps)				Yes	--
it may be required to have the ability to activate and deactivate a stage by an external signal.				Yes	
This protection trips in the range from 0.2Un to 1.20Un.it is inhibited for input voltages of less than 20 % Un				Yes	
Parameter	Settings	Test 1	Test 2	Test 3	Limits
Trip value [Hz]	52.0	52.02	52.03	52.04	52.0±0.05
Trip time [s]	0.1	0.094	0.098	0.107	0.1±10%
Parameter	Settings	Test 1	Test 2	Test 3	Limits
Trip value [Hz]	52.0	52.02	52.03	52.04	52.0±0.05
Trip time [s]	5	5.06	5.06	5.08	5±10%

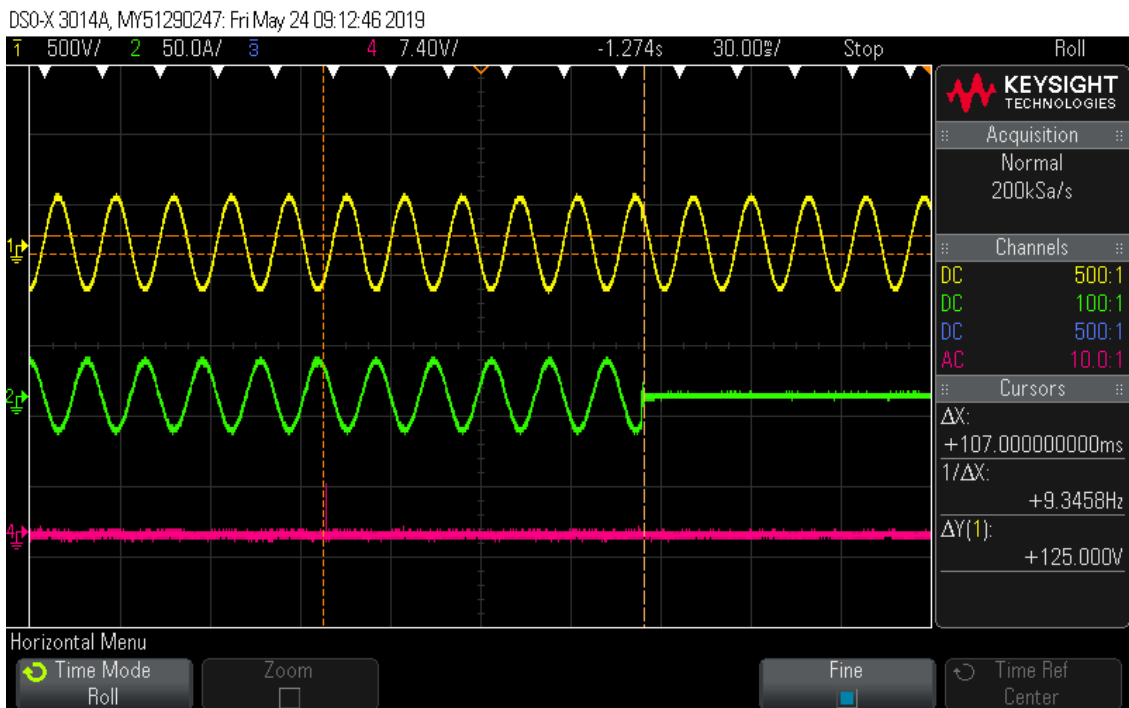

Trip time (0.1s setting)

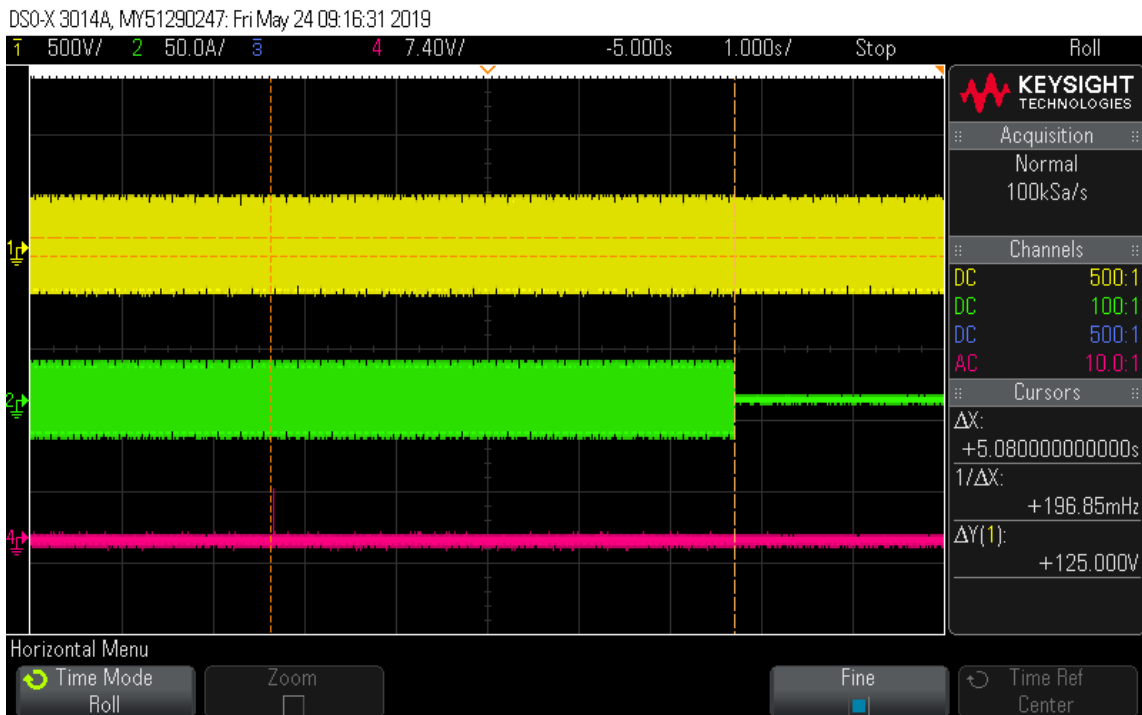

Trip time (5s setting)

4.9.4.2		Table: Islanding							P
No.	PEUT ¹⁾ (% of EUT rating)	Reactive load (% of QL in 6.1.d)1)	PAC ²⁾ (% of nominal)	QAC ³⁾ (% of nominal)	Run on time (ms)	PEUT (KW)	Actual Qf	VDC	Remarks ⁴⁾
1	100	100	0	0	992.0	33.74	1.00	850	Test A at BL
2	66	66	0	0	779.0	21.96	1.00	600	Test B at BL
3	33	33	0	0	930.0	11.38	1.00	300	Test C at BL
4	100	100	-5	-5	523.0	33.74	0.98	850	Test A at IB
5	100	100	-5	0	663.0	33.74	0.95	850	Test A at IB
6	100	100	-5	5	637.0	33.74	0.93	850	Test A at IB
7	100	100	0	-5	956.0	33.74	1.03	850	Test A at IB
8	100	100	0	5	534.0	33.75	0.97	850	Test A at IB
9	100	100	5	-5	557.0	33.74	1.02	850	Test A at IB
10	100	100	5	0	951.0	33.74	1.08	850	Test A at IB
11	100	100	5	5	695.0	33.74	1.04	850	Test A at IB
12	66	66	0	-5	854.0	21.96	1.02	600	Test B at IB
13	66	66	0	-4	876.0	21.96	1.02	600	Test B at IB
14	66	66	0	-3	887.0	21.96	1.02	600	Test B at IB
15	66	66	0	-2	972.0	21.96	1.01	600	Test B at IB
16	66	66	0	-1	630.0	21.96	1.01	600	Test B at IB
17	66	66	0	1	992.0	21.96	0.99	600	Test B at IB
18	66	66	0	2	903.0	21.96	0.99	600	Test B at IB
19	66	66	0	3	979.0	21.96	0.98	600	Test B at IB
20	66	66	0	4	985.0	21.96	0.98	600	Test B at IB
21	66	66	0	5	946.0	21.96	0.97	600	Test B at IB
22	33	33	0	-5	916.0	11.38	1.03	300	Test C at IB
23	33	33	0	-4	930.0	11.38	1.03	300	Test C at IB
24	33	33	0	-3	905.0	11.38	1.02	300	Test C at IB
25	33	33	0	-2	946.0	11.38	1.01	300	Test C at IB
26	33	33	0	-1	836.0	11.38	1.01	300	Test C at IB
27	33	33	0	1	992.0	11.38	0.99	300	Test C at IB
28	33	33	0	2	984.0	11.38	0.99	300	Test C at IB
29	33	33	0	3	943.0	11.38	0.99	300	Test C at IB
30	33	33	0	4	953.0	11.38	0.98	300	Test C at IB
31	33	33	0	5	950.0	11.38	0.98	300	Test C at IB

Remark:

- 1) PEUT: EUT output power
- 2) PAC: Real power flow at S1 in Figure 1. Positive means power from EUT to utility. Nominal is the 0% test condition value.
- 3) QAC: Reactive power flow at S1 in Figure 1. Positive means power from EUT to utility. Nominal is the 0% test condition value.
- 4) BL: Balance condition, IB: Imbalance condition.
- 5) *Note: test condition A (100%): If any of the recorded run-on times are longer than the one recorded for the rated balance condition, i.e. test procedure 6.1 f), then the non-shaded parameter combinations (no.32~47) also require testing.

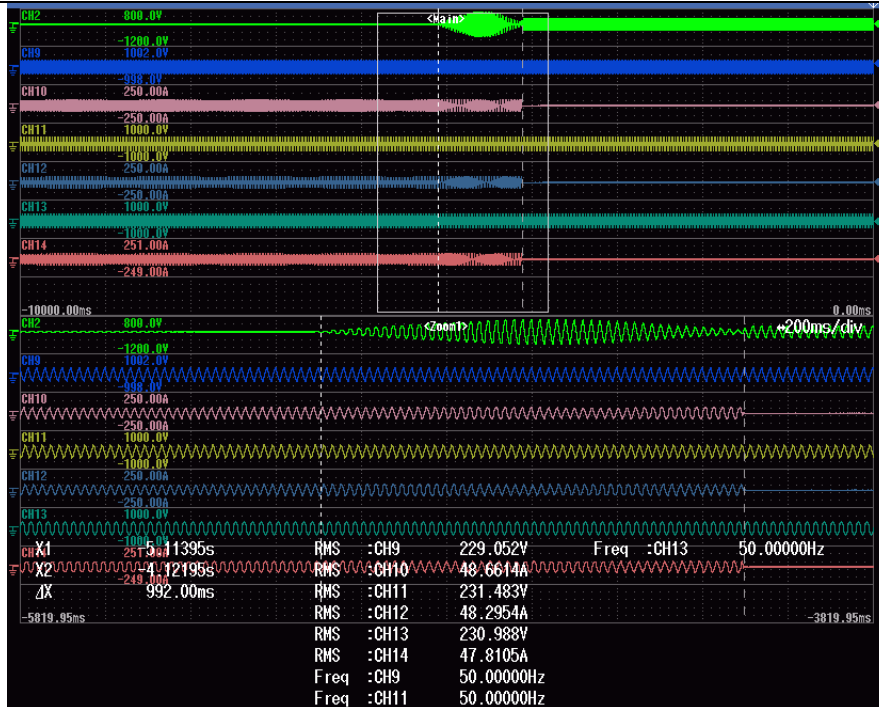

P_{EUT} 100%, P_{AC} 0%, Q_{AC} 0%, = 992ms

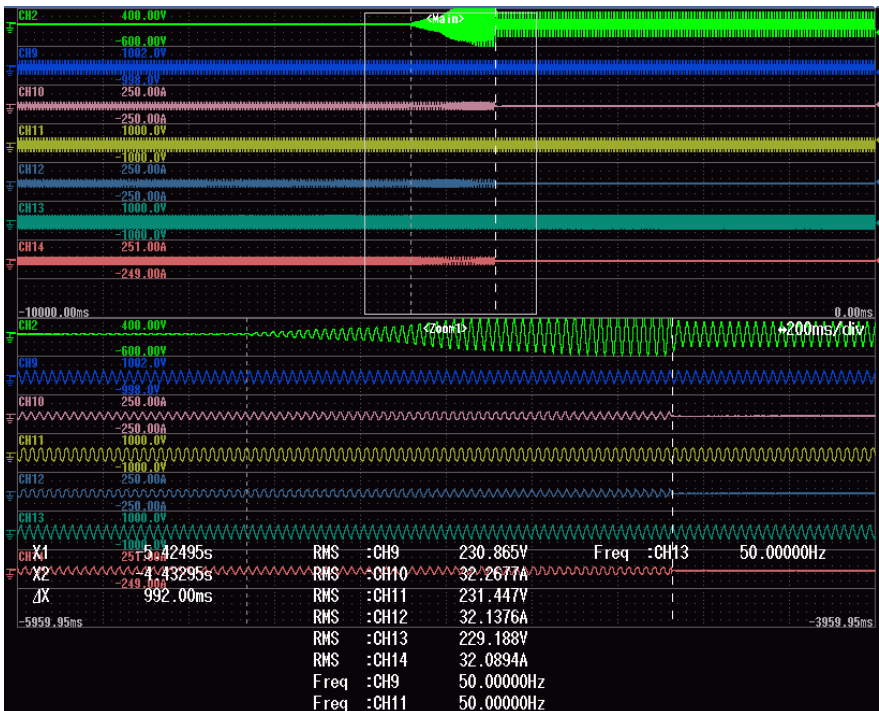

P_{EUT} 66%, P_{AC} 0%, Q_{AC} 1%, = 992.0ms

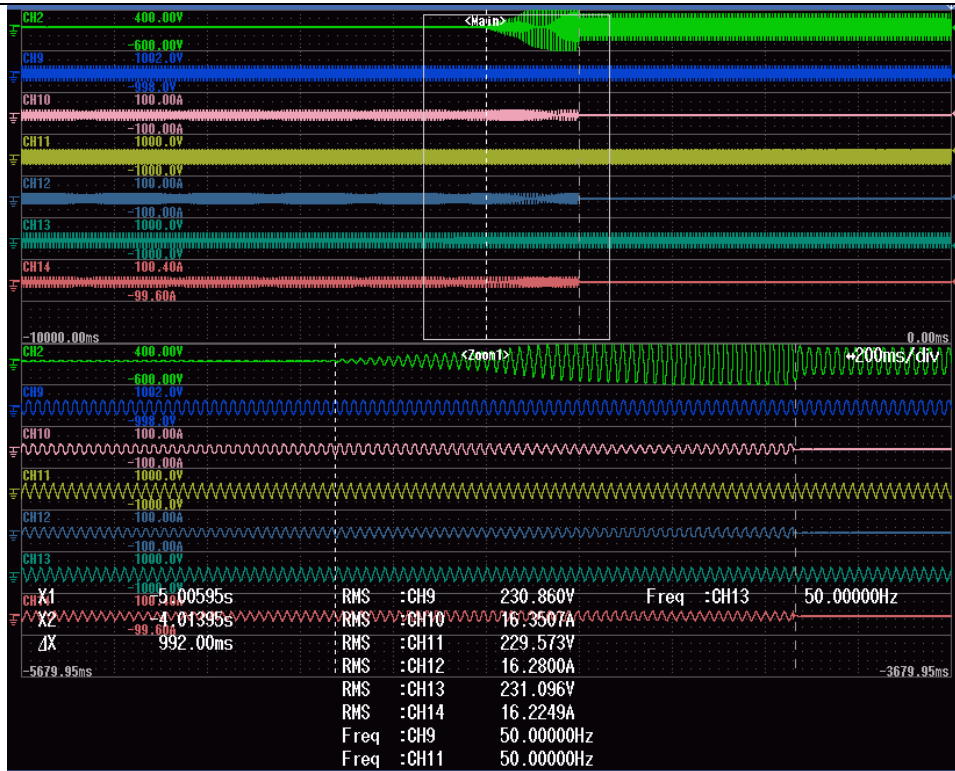

$P_{EUT} 33\%$, $P_{AC} 0\%$, $Q_{AC} 1\%$, = 992.0ms

Note: CH10,CH12,CH14 denotes current of EUT; CH2 denotes Voltage of signal (the signal from switch), CH9,CH11,CH13 denotes Voltage of Grid

4.10.2	Table: Reconnection after tripping			P
Table 3 — Automatic reconnection after tripping				
Parameter	Range	Default setting		
Lower frequency	47,0Hz – 50,0Hz	49,5Hz		
Upper frequency	50,0Hz – 52,0Hz	50,2Hz		
Lower voltage	50% – 100%U _n	85 % U _n		
Upper voltage	100% – 120% U _n	110 % U _n		
Observation time	10s – 600s	60s		
Active power increase gradient	6% – 3000%/min	10%/min		
Test sequence after trip	connection	connection allowed	Observation time (s)	Power gradient after connection
Step a)	47.0Hz – 50.0Hz adjustable <47.0Hz setting	No	--	--
Step b)	47.0Hz – 50.0Hz ≥49.50Hz setting	Yes	10s setting Measured: 24s	6%P _n /min setting Measured:6.09% P _n /min
Step c)	50.0Hz – 52.0Hz adjustable >52.0Hz setting	No	--	--
Step d)	50.0Hz – 52.0Hz adjustable ≤50.2Hz setting	Yes	600s setting Measured:607s	3000%P _n /min setting Measured:2937 %P _n /min
Step e)	115V – 230V adjustable <195.5V setting	No	--	--
Step f)	115V – 230V adjustable ≥195.5V setting	Yes	10s setting Measured:24s	6%P _n /min setting Measured:6.61% P _n /min
Step g)	230V – 276V adjustable >253V setting	No	--	--
Step h)	230V – 276V adjustable ≤253V setting	Yes	600s setting Measured:606.6s	3000%P _n /min setting Measured:2817 %P _n /min

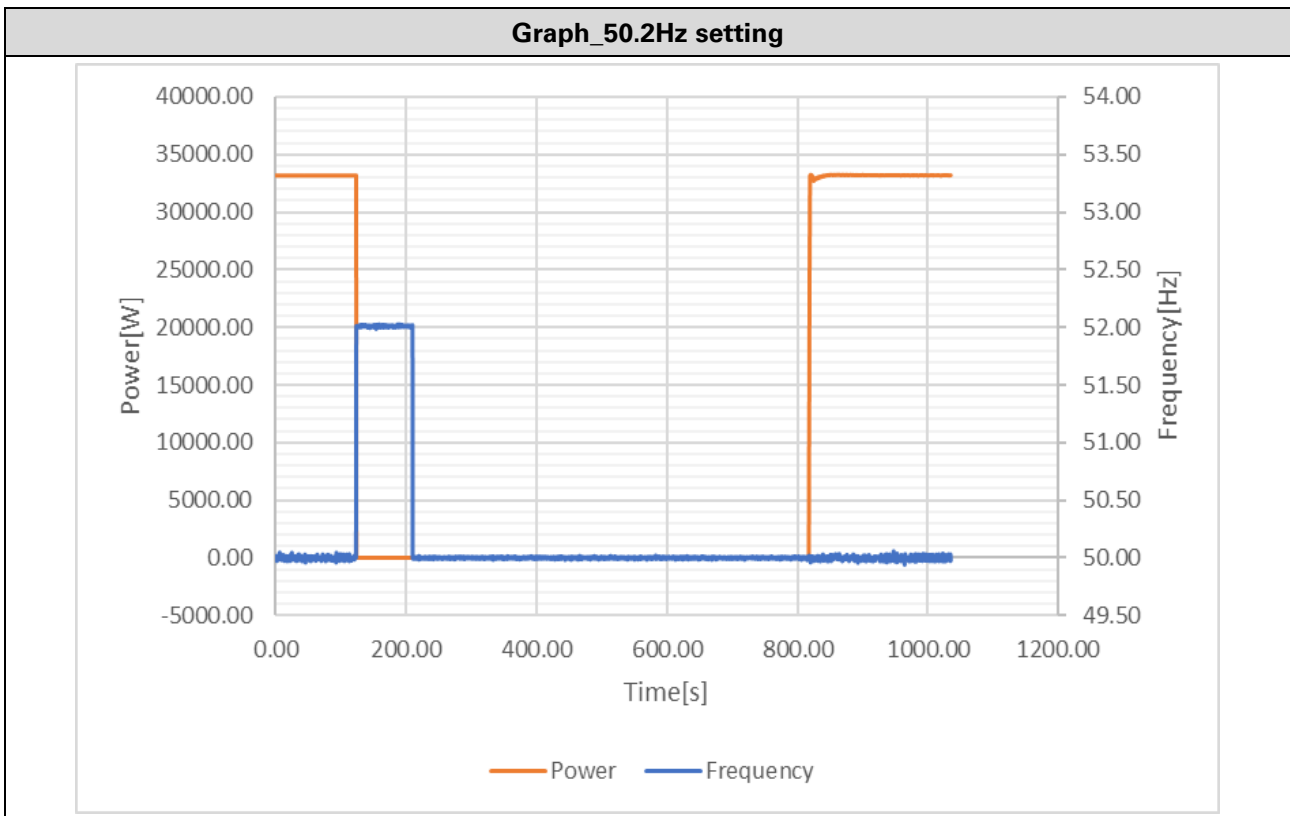
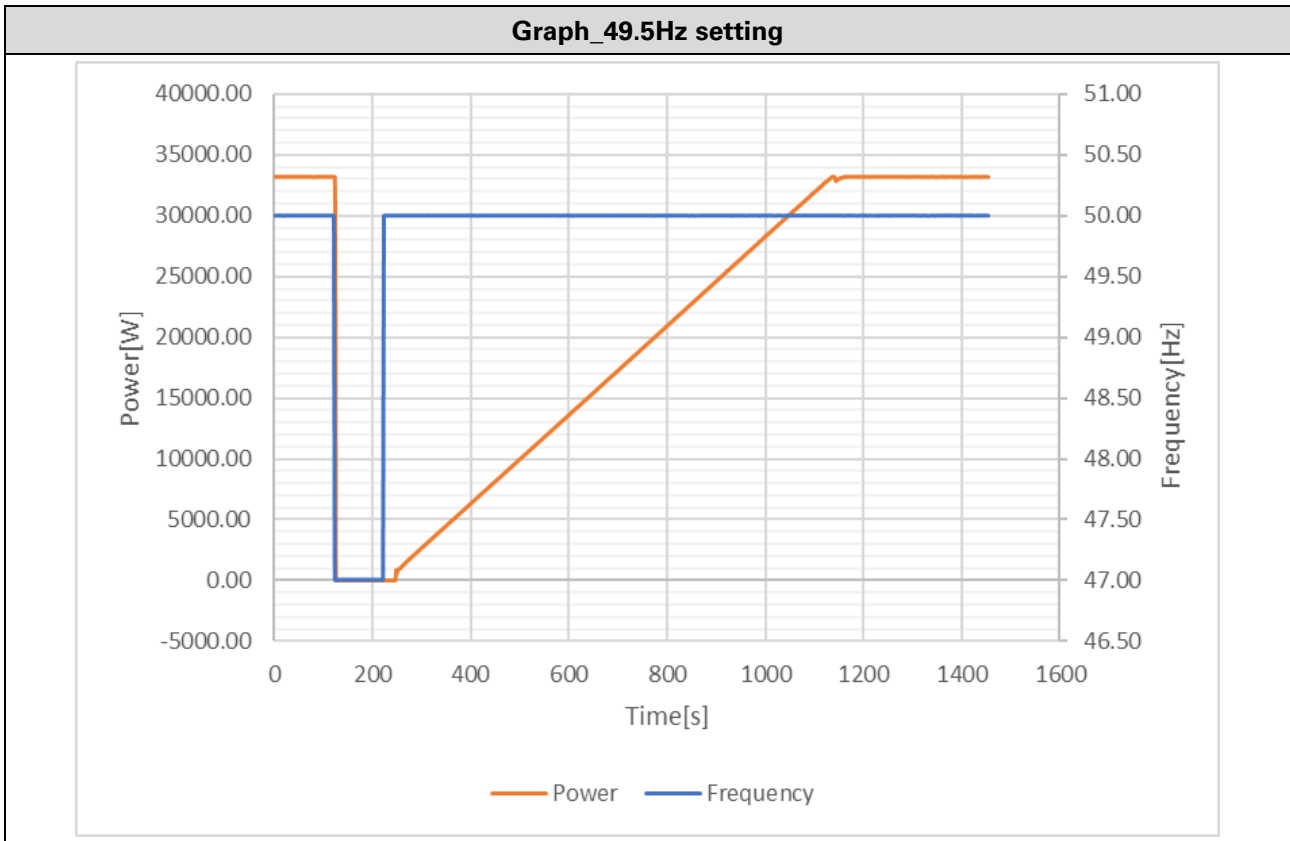

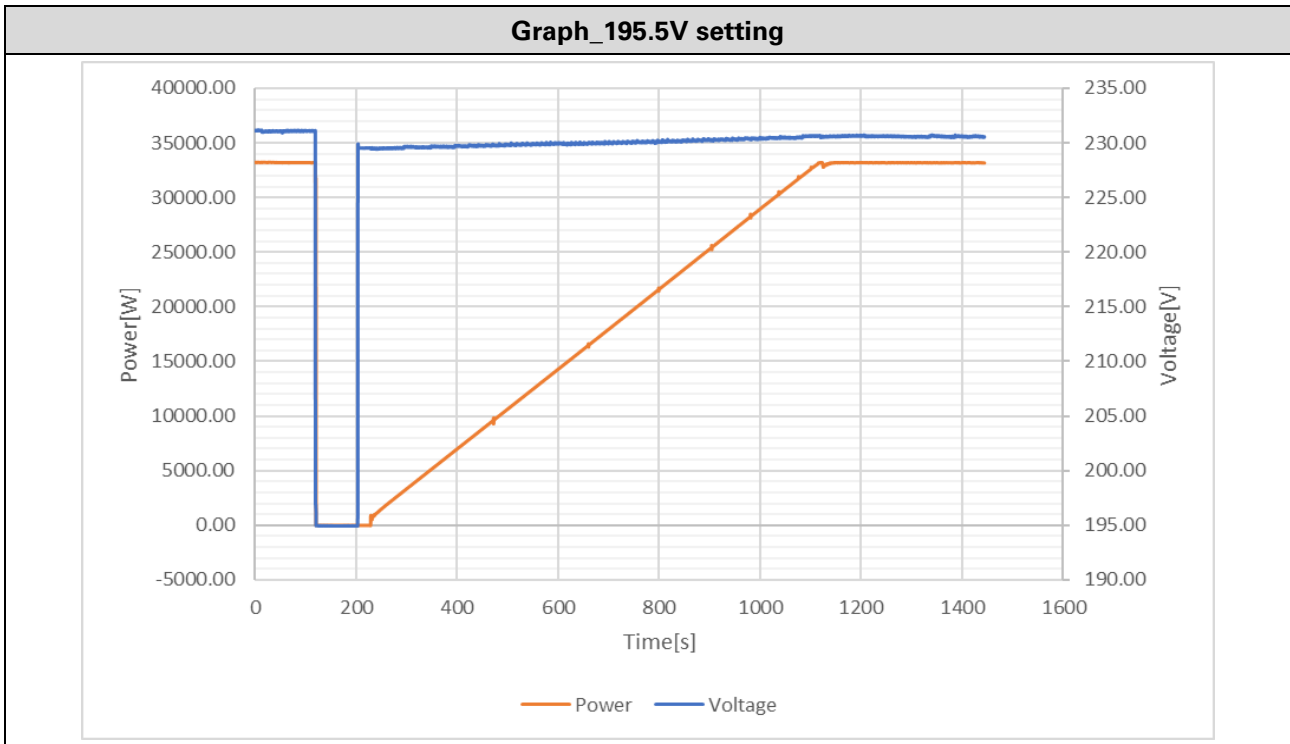

4.10.3	Table: Starting to generate electrical power			P																					
Table 4 — Starting to generate electrical power																									
<table border="1"> <thead> <tr> <th data-bbox="183 414 590 459">Parameter</th> <th data-bbox="598 414 1005 459">Range</th> <th data-bbox="1013 414 1404 459">Default setting</th> </tr> </thead> <tbody> <tr> <td data-bbox="183 465 590 510">Lower frequency</td> <td data-bbox="598 465 1005 510">47,0Hz – 50,0Hz</td> <td data-bbox="1013 465 1404 510">49,5Hz</td> </tr> <tr> <td data-bbox="183 517 590 562">Upper frequency</td> <td data-bbox="598 517 1005 562">50,0Hz – 52,0Hz</td> <td data-bbox="1013 517 1404 562">50,1Hz</td> </tr> <tr> <td data-bbox="183 568 590 613">Lower voltage</td> <td data-bbox="598 568 1005 613">50% – 100% U_n</td> <td data-bbox="1013 568 1404 613">85 % U_n</td> </tr> <tr> <td data-bbox="183 620 590 665">Upper voltage</td> <td data-bbox="598 620 1005 665">100% – 120% U_n</td> <td data-bbox="1013 620 1404 665">110 % U_n</td> </tr> <tr> <td data-bbox="183 672 590 716">Observation time</td> <td data-bbox="598 672 1005 716">10s – 600s</td> <td data-bbox="1013 672 1404 716">60s</td> </tr> <tr> <td data-bbox="183 723 590 768">Active power increase gradient</td> <td data-bbox="598 723 1005 768">6% – 3000%/min</td> <td data-bbox="1013 723 1404 768">disabled</td> </tr> </tbody> </table>					Parameter	Range	Default setting	Lower frequency	47,0Hz – 50,0Hz	49,5Hz	Upper frequency	50,0Hz – 52,0Hz	50,1Hz	Lower voltage	50% – 100% U _n	85 % U _n	Upper voltage	100% – 120% U _n	110 % U _n	Observation time	10s – 600s	60s	Active power increase gradient	6% – 3000%/min	disabled
Parameter	Range	Default setting																							
Lower frequency	47,0Hz – 50,0Hz	49,5Hz																							
Upper frequency	50,0Hz – 52,0Hz	50,1Hz																							
Lower voltage	50% – 100% U _n	85 % U _n																							
Upper voltage	100% – 120% U _n	110 % U _n																							
Observation time	10s – 600s	60s																							
Active power increase gradient	6% – 3000%/min	disabled																							
Test sequence after trip	connection	connection allowed	Observation time (s)	Power gradient after connection																					
Step a)	47.0Hz – 50.0Hz adjustable <49.5Hz setting	No	--	--																					
Step b)	47.0Hz – 50.0Hz ≥49.5Hz setting	Yes	60s setting Measured: 67.5s	100%Pn/min setting Measured:103% Pn/min																					
Step c)	50.0Hz – 52.0Hz adjustable >50.1Hz setting	No	--	--																					
Step d)	50.0Hz – 52.0Hz adjustable ≤50.1Hz setting	Yes	60s setting Measured:64.5s	100%Pn/min setting Measured:103% Pn/min																					
Step e)	115V – 230V adjustable <195.5V setting	No	--	--																					
Step f)	115V – 230V adjustable ≥195.5V setting	Yes	60s setting Measured: 67.0s	100%Pn/min setting Measured:110% Pn/min																					
Step g)	230V – 276V adjustable >253V setting	No	--	--																					
Step h)	230V – 276V adjustable ≤253V setting	Yes	60s setting Measured:69.5s	100%Pn/min setting Measured:106% Pn/min																					

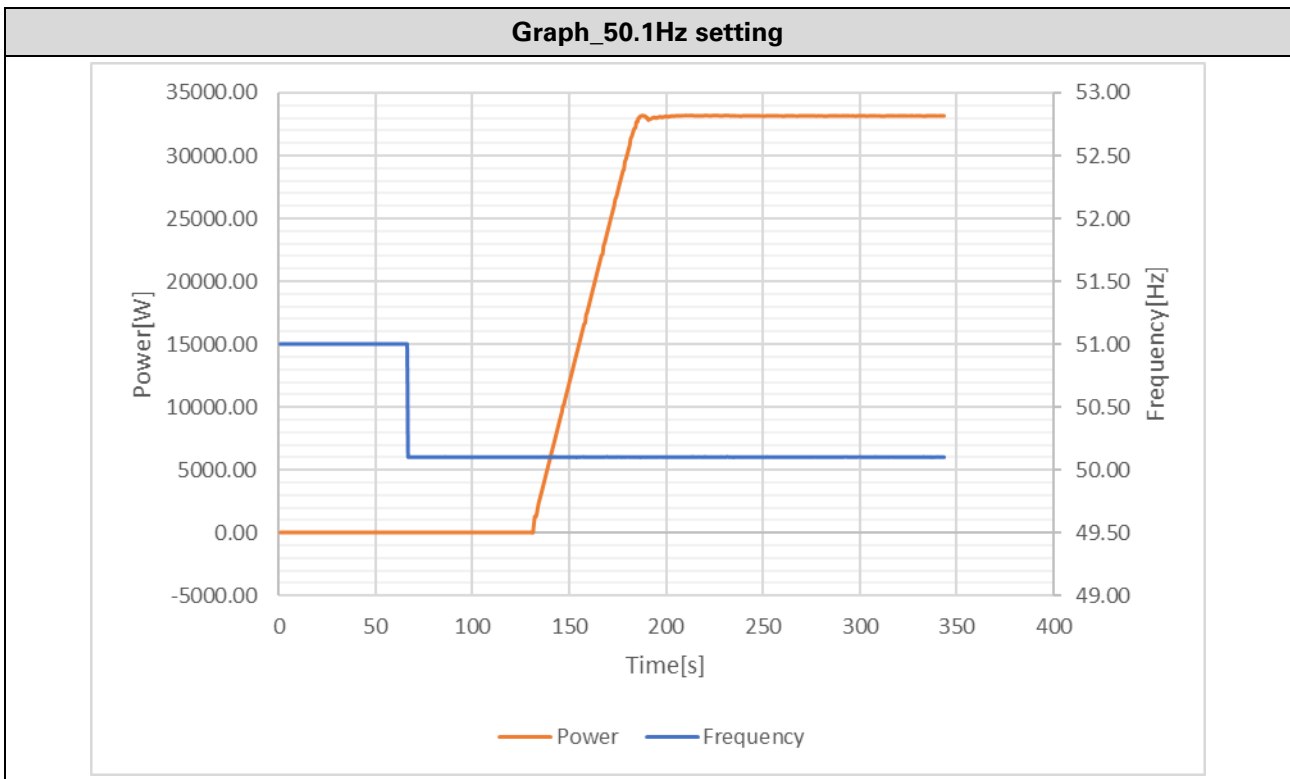
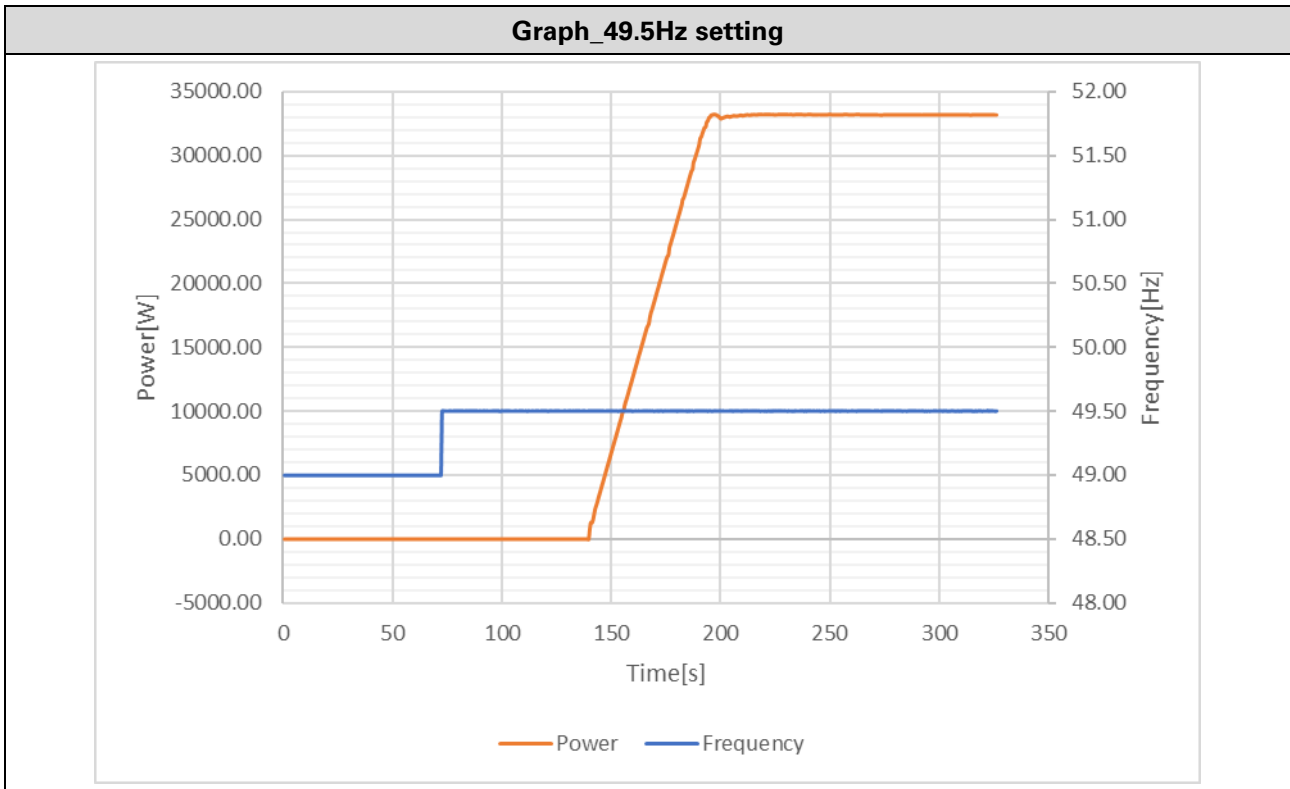

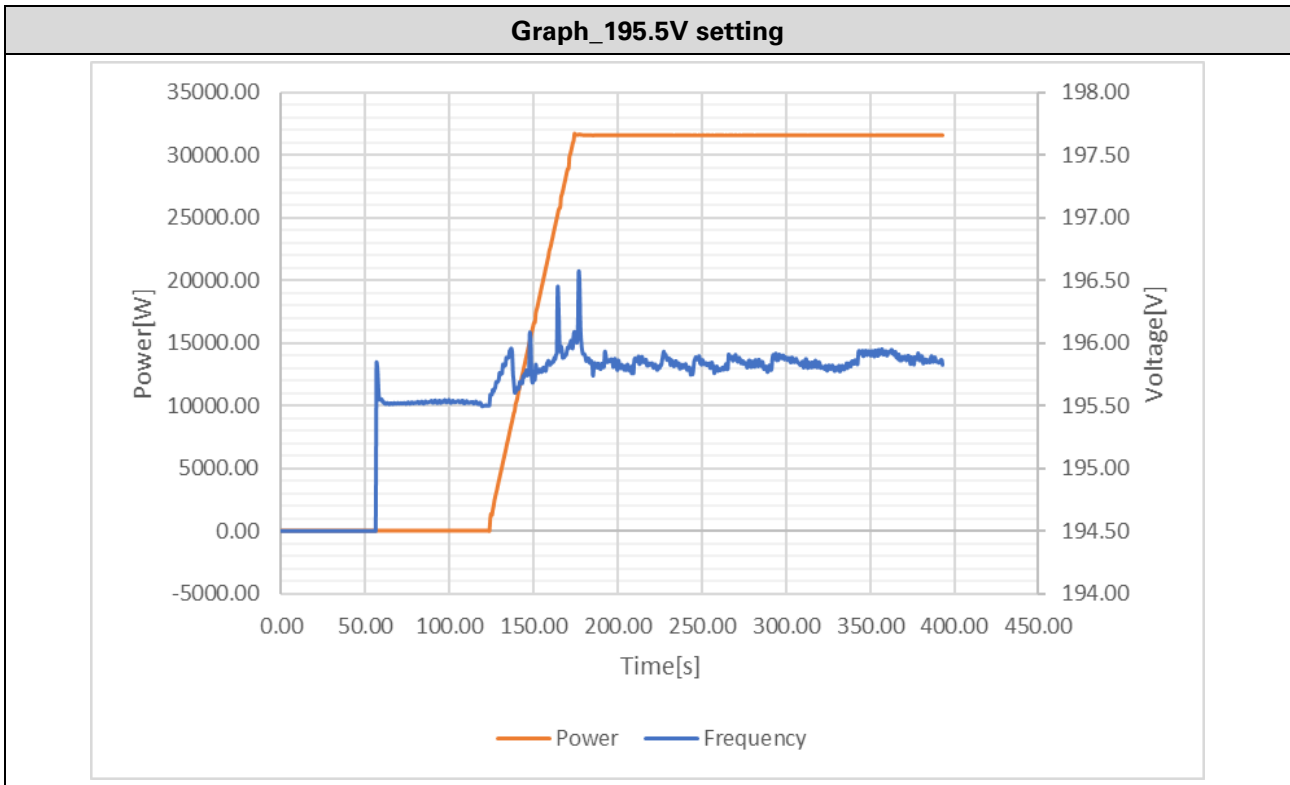

4.11		Table: Active power reduction by setpoint and Ceasing active power (Logic interface)					P	
String	1	U _{DC} =	800 Vdc	U _{ac} = U _n	230 Vac	P _{E_{max}} (KW)	33.0	
1 min mean value P/P _n Psetpoint (%)			P _{measured} (%)	ΔP _{measured} (%)	Limit [%]			
100%			100.88	0.88	±5%			
90%			89.75	-0.25	±5%			
80%			79.61	-0.39	±5%			
70%			70.01	0.01	±5%			
60%			59.88	-0.12	±5%			
50%			49.79	-0.21	±5%			
40%			39.73	-0.27	±5%			
30%			29.69	-0.31	±5%			
20%			19.93	-0.07	±5%			
10%			10.27	0.27	±5%			
The power gradient for increasing and reducing (%P _n /s)						0.50%P _n /s		
Time for Logic interface (at input port) activated						0.836s		

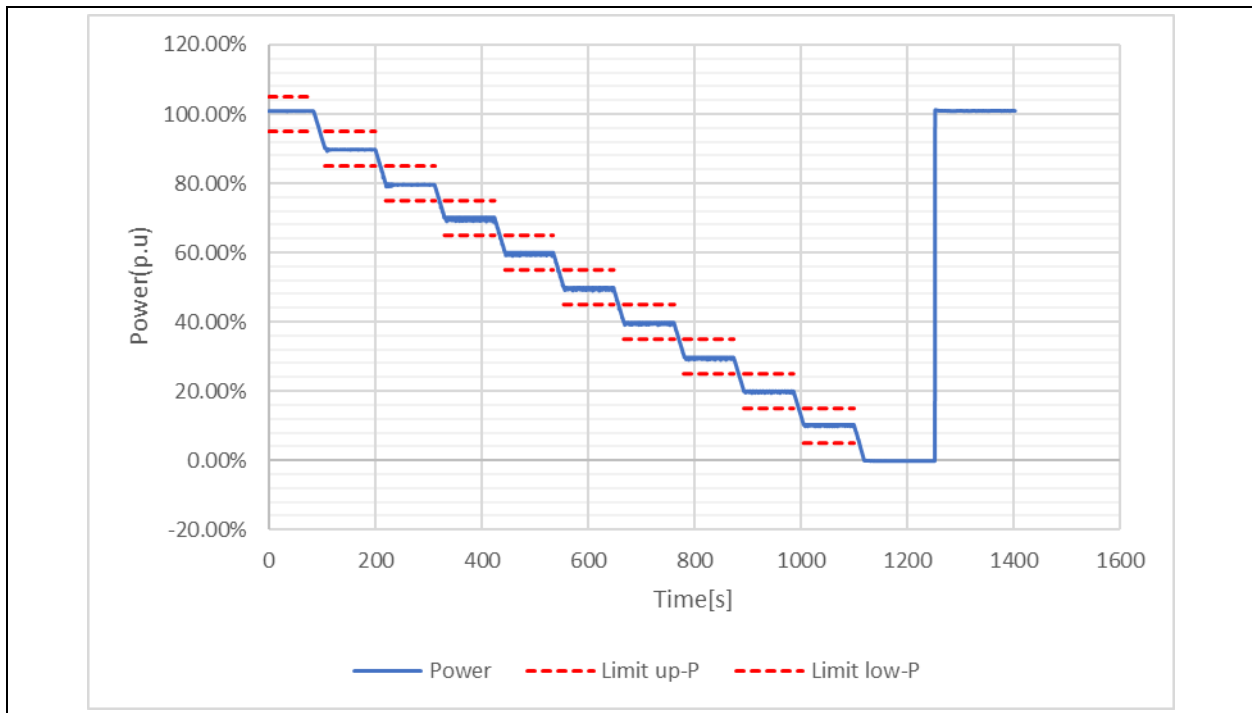

Waveform for logic interface

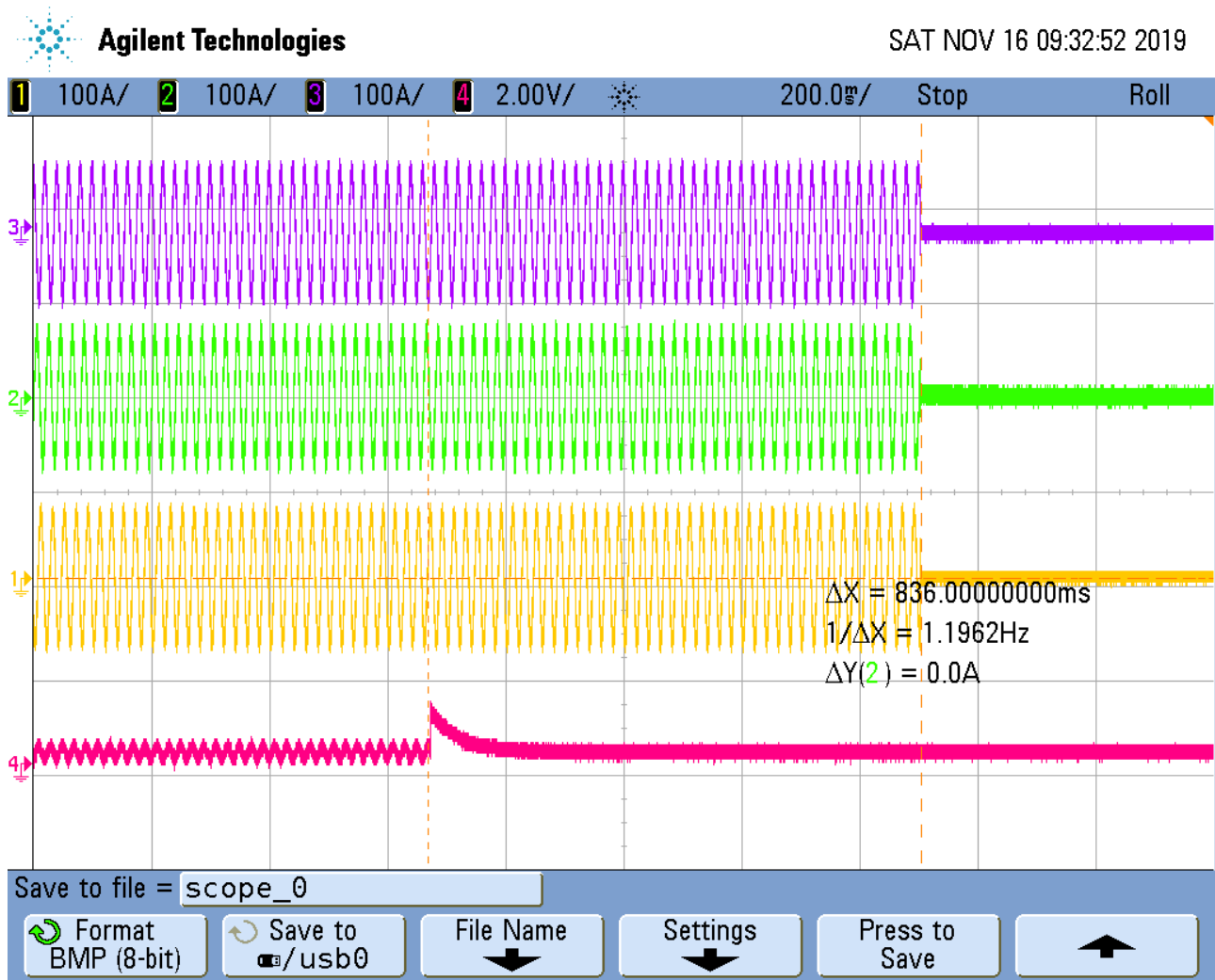

Remark: Once activation, the inverter will cease the power during 5s, detail also refer to instruction manual

4.13		TABLE: Single fault tolerance					P
		ambient temperature (°C) :				25	
		model/type of power supply :				PV simulator	
No.	component No.	fault	test voltage (V)	test time	fuse No.	fuse current (A)	result
1.	XLC2 Pin 2 to 3	Short	850	10 min	--	--	Inverter operated normally. No damaged.No hazards.
2.	RB 137	Open	850	10 min	--	--	Inverter disconnected from grid immediately. Error message:" The grid voltage error". No damaged.No hazards.
3.	RB 139	Short	850	10 min	--	--	Inverter disconnected from grid immediately. Error message:" The grid voltage error". No damaged.No hazards.
4.	RB 131	Open	850	10 min	--	--	Inverter disconnected from grid immediately. Error message:" The grid voltage error". No damaged.No hazards.
5.	RB 122	Open	850	10 min	--	--	Inverter disconnected from grid immediately. Error message:" The grid voltage error". No damaged.No hazards.
6.	RB 110	Short	850	10 min	--	--	Inverter disconnected from grid immediately. Error message:" The grid voltage error". No damaged.No hazards.
7.	RB 96	Short	850	10 min	--	--	Inverter disconnected from grid immediately. Error message:"GFCI error". No damaged.No hazard.
8.	RB 11	Open	850	10 min	--	--	Inverter disconnected from grid immediately. Error message:"GFCI error". No damaged.No hazard.
9.	RB 8	Short	850	10 min	--	--	Inverter disconnected from grid immediately. Error message:"GFCI error". No damaged.No hazard.
10.	UB1 PIN5 to 6	Short	850	10 min	--	--	Inverter disconnected from grid immediately. Error message:"GFCI error". No damaged.No hazard.

11.	RB 23	Short	850	10 min	--	--	Inverter disconnected from grid immediately. Error message:"GFCI error". No damaged.No hazard.
12.	QD1 PIN1 to 2	Short	850	10 min	--	--	Inverter disconnected from grid immediately. Error message:"The DCI overcurrent". No damaged.No hazard.
13.	XLC2 PIN1 to 2	Short	850	10 min	--	--	Inverter disconnected from grid immediately. Error message:"The communication error". No damaged.No hazard.
14.	DC 71	Short	850	10 min	--	--	Inverter disconnected from grid immediately. Error message:"The communication error". No damaged.No hazard.
15.	U13 PIN2 to 3	Short	850	10 min	--	--	Inverter disconnected from grid immediately. Error message:"The communication error". No damaged.No hazard.
16.	XLC1 PIN1 to 2	Short	850	10 min	--	--	Inverter did not start-up. Error message:"The SPI error" No damage.No hazard.
17.	RC6	Short	850	10 min	--	--	Inverter disconnected from grid immediately. Error message:" The grid voltage error". No damaged.No hazards.
18.	RC19	Short	850	10 min	--	--	Inverter disconnected from grid immediately. Error message:" The grid voltage error". No damaged.No hazards.
19.	UC627 PIN2 to 3	Short	850	10 min	--	--	Inverter disconnected from grid immediately. Error message:" The grid voltage error". No damaged.No hazards.
20.	UC637 PIN12 to 13	Short	850	10 min	--	--	Inverter disconnected from grid immediately. Error message:"GFCI error". No damaged.No hazard.
21.	RC 167	Short before start-up	850	10 min	--	--	Inverter did not start-up. Error message:"The ISO error" No damage.No hazard.
22.	RC 98	Short before start-up	850	10 min	--	--	Inverter did not start-up. Error message:"The ISO error" No damage.No hazard.

Supplement:

s-c: short-circuited, o-c: open-circuited, o-l: overload

Appended photos

Enclosure front view: SOFAR 20000TL-G2

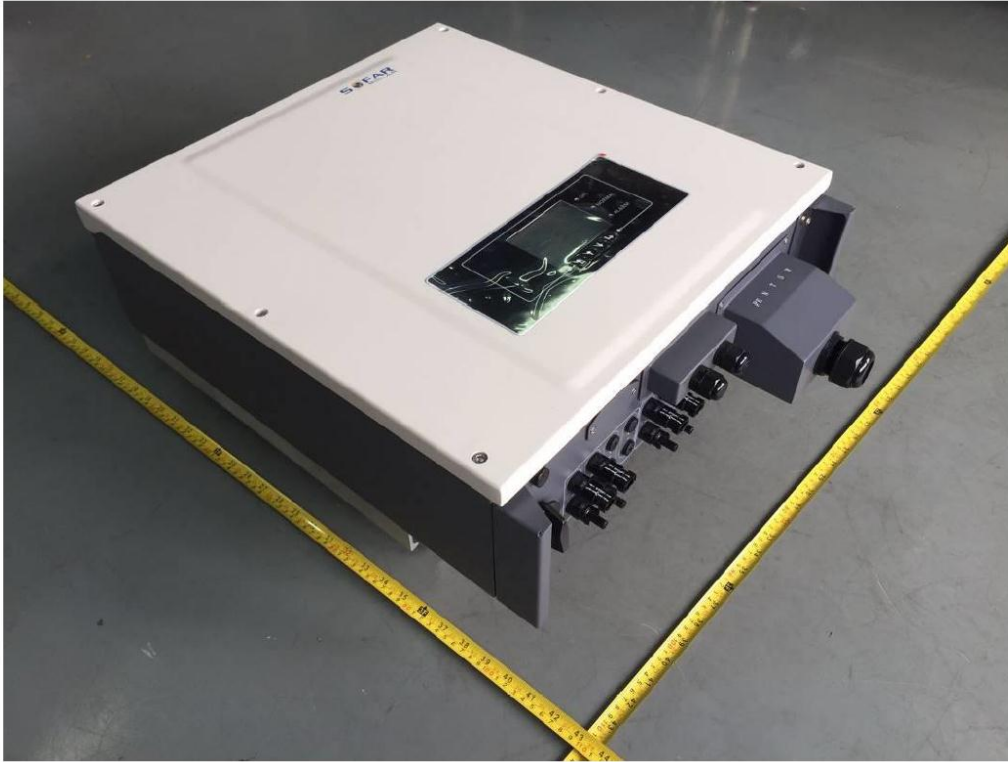

Enclosure rear view: SOFAR 20000TL-G2

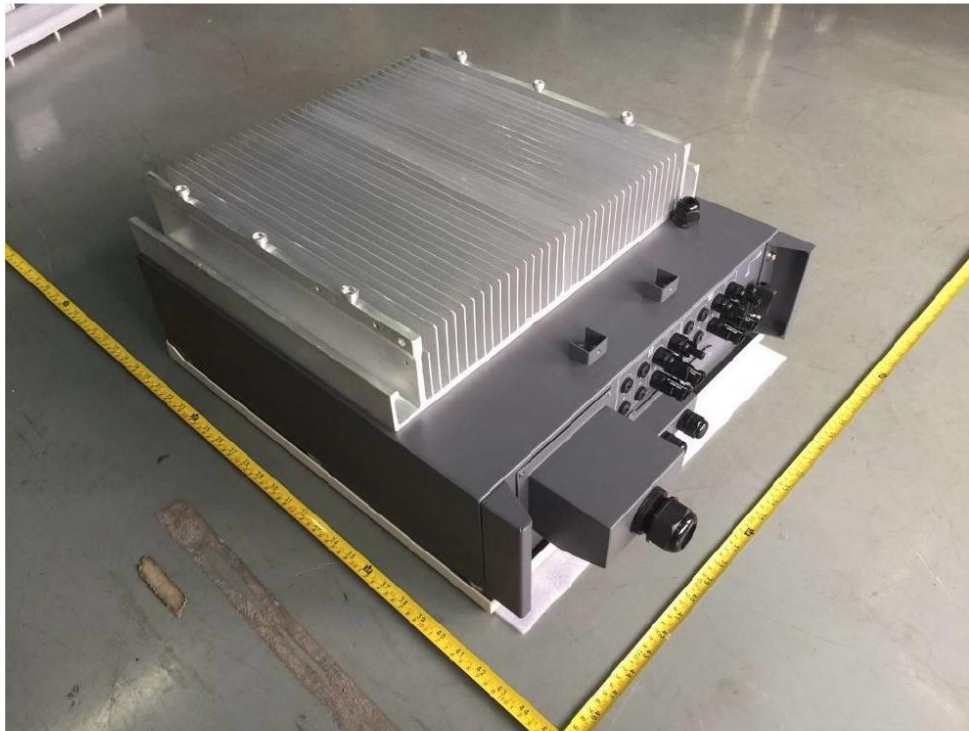

Enclosure front view: SOFAR 25000TL-G2

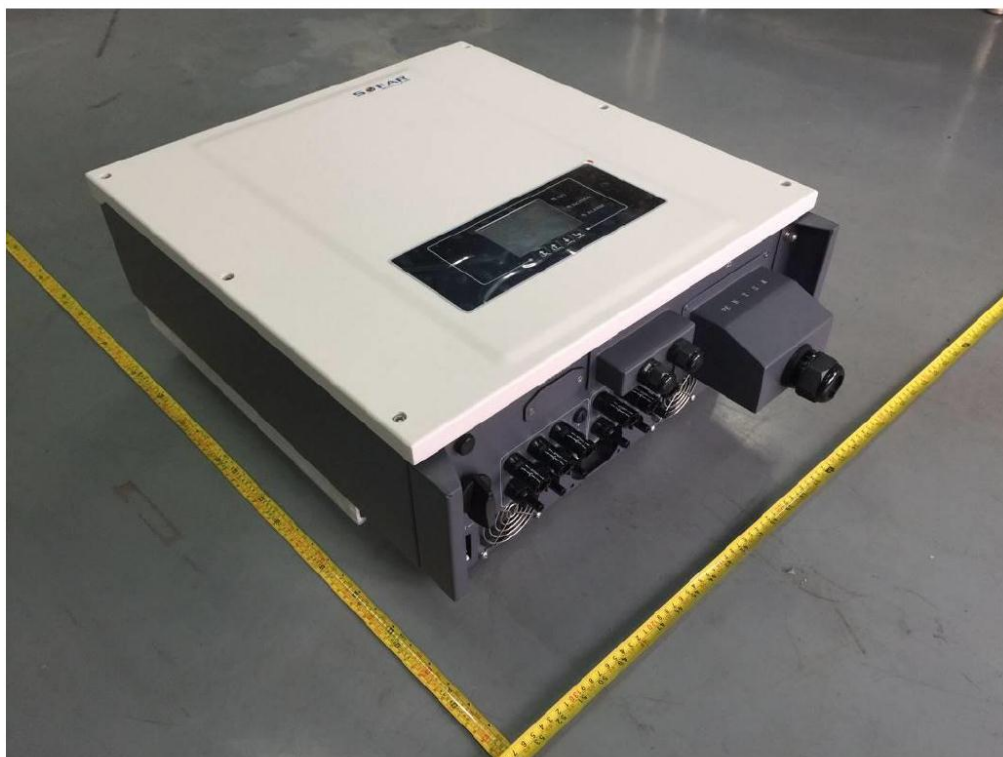

Enclosure rear view: SOFAR 25000TL-G2



Enclosure front view: SOFAR 30000TL-G2, SOFAR 33000TL-G2



Enclosure rear view: SOFAR 30000TL-G2, SOFAR 33000TL-G2



Enclosure terminal view: SOFAR 20000TL-G2



Enclosure terminal view: SOFAR 25000TL-G2



Enclosure terminal view: SOFAR 30000TL-G2, SOFAR 33000TL-G2



Internal view: SOFAR 20000TL-G2



Internal view: SOFAR 25000TL-G2



Internal view: SOFAR 30000TL-G2, SOFAR 33000TL-G2

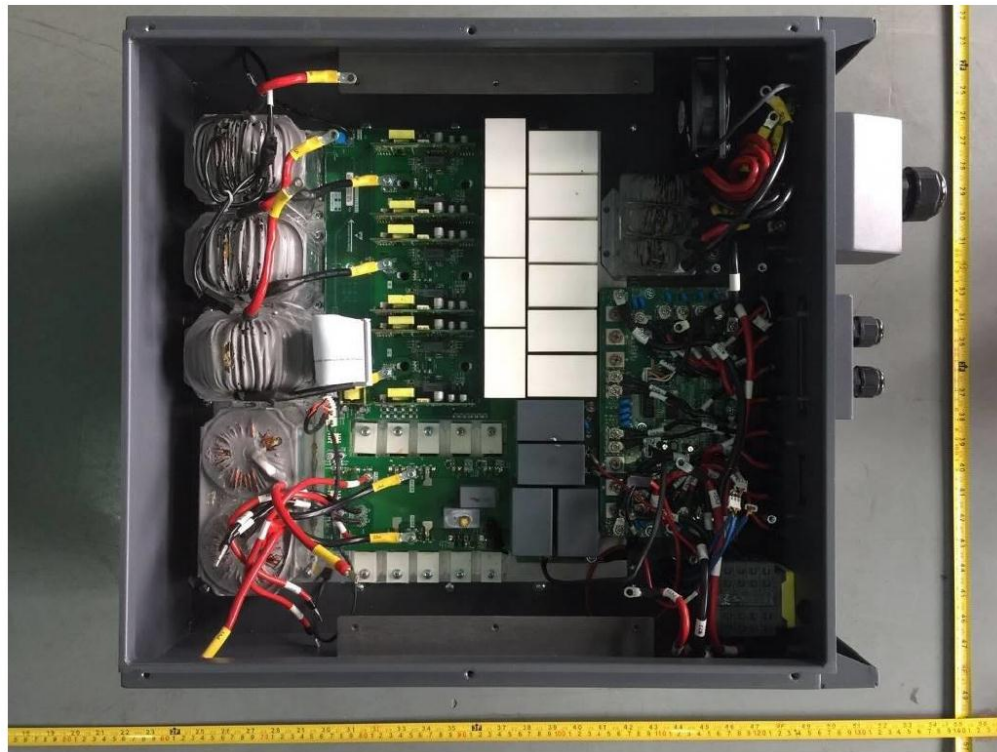

(End of report)