

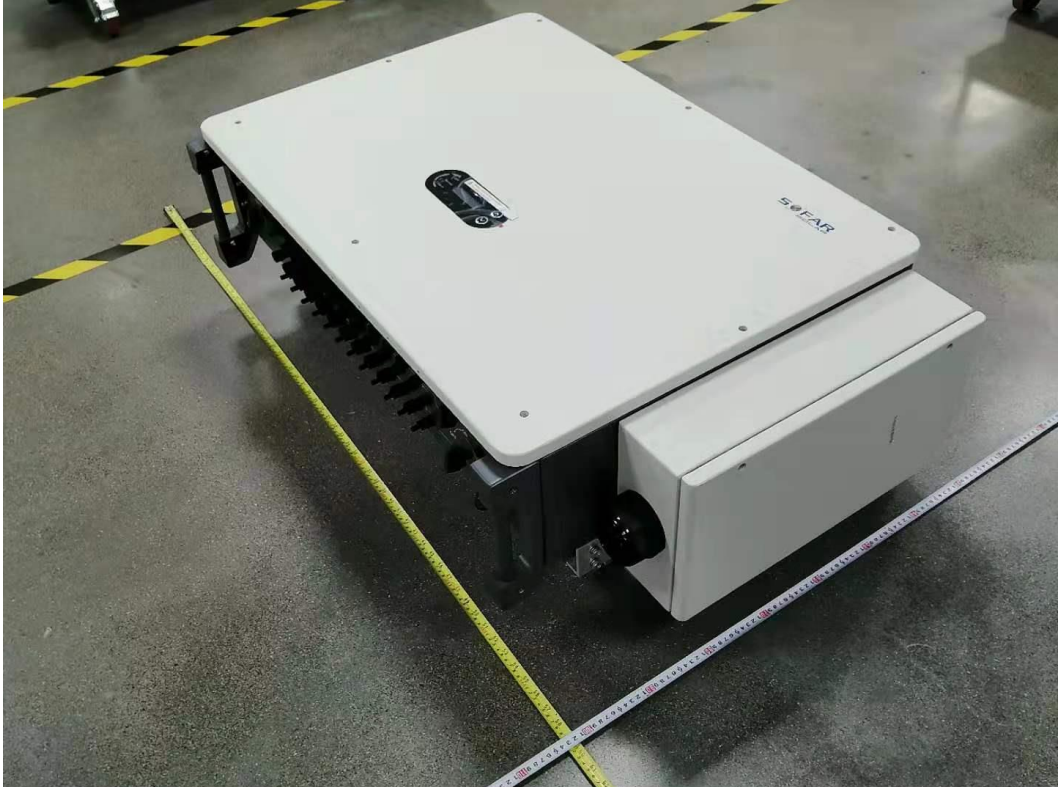

# Attachment

## Photo Documentation

Details of:	Figure.1 Overall view1
<b>View:</b> <input checked="" type="checkbox"/> General	

Details of:	Figure.2 Overall view2
<b>View:</b> <input checked="" type="checkbox"/> General	

**Attachment**

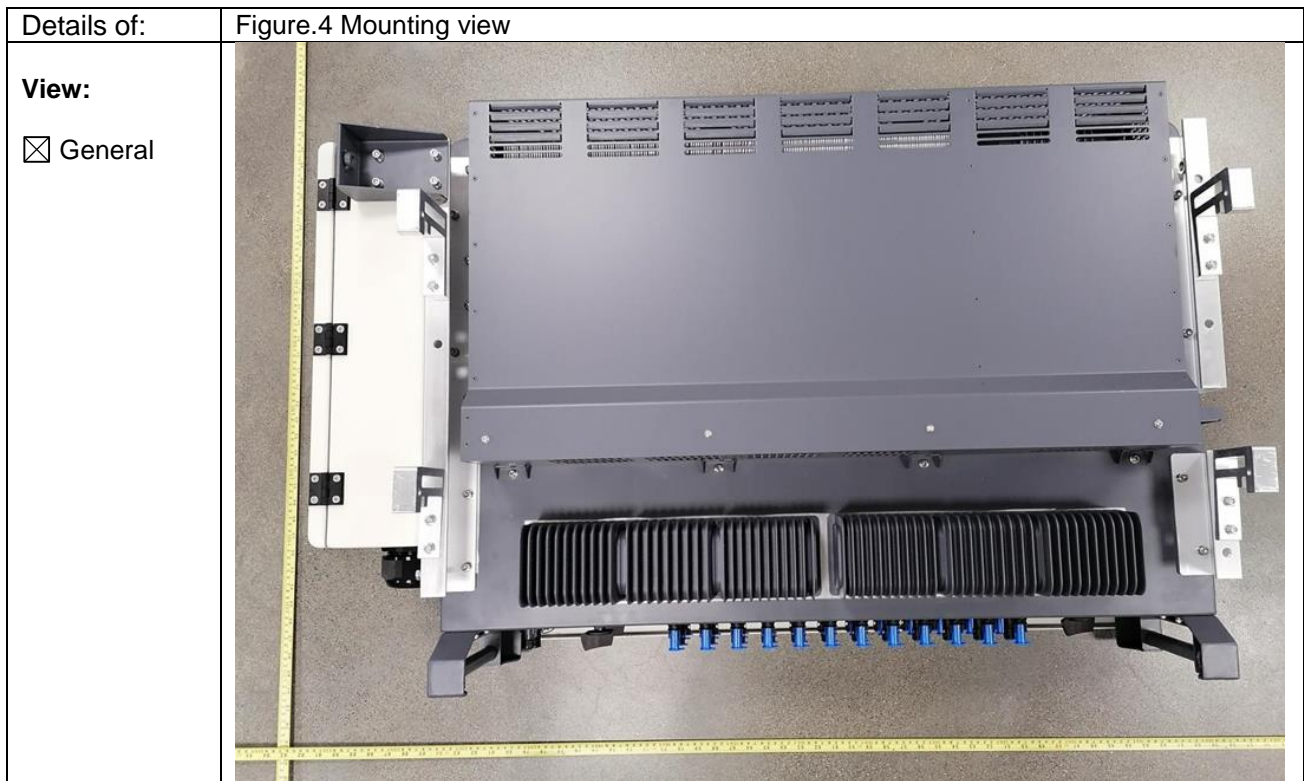
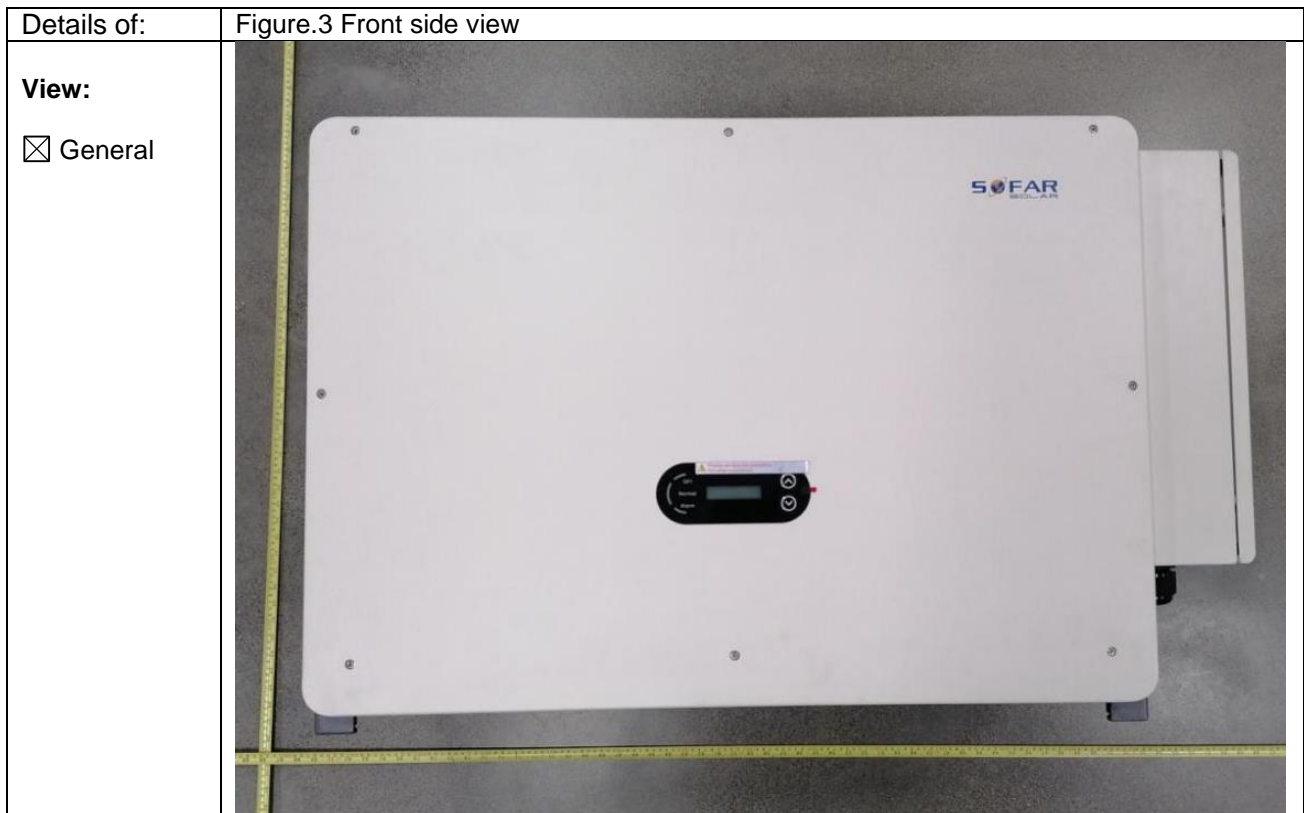

# Attachment

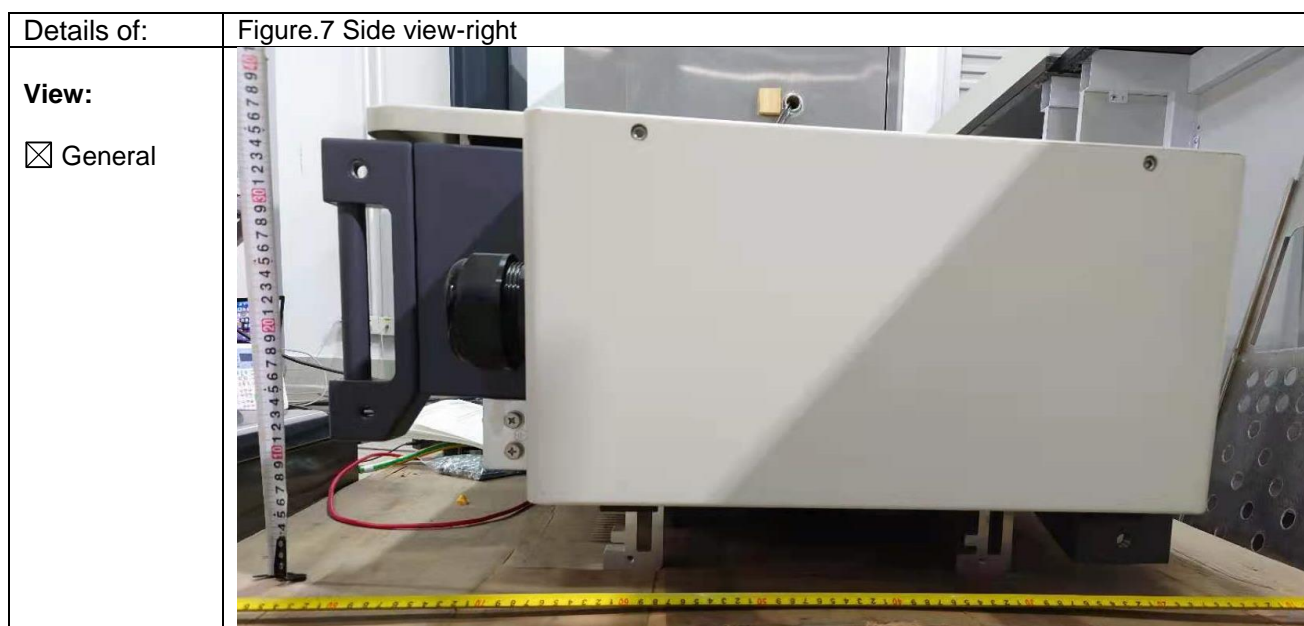
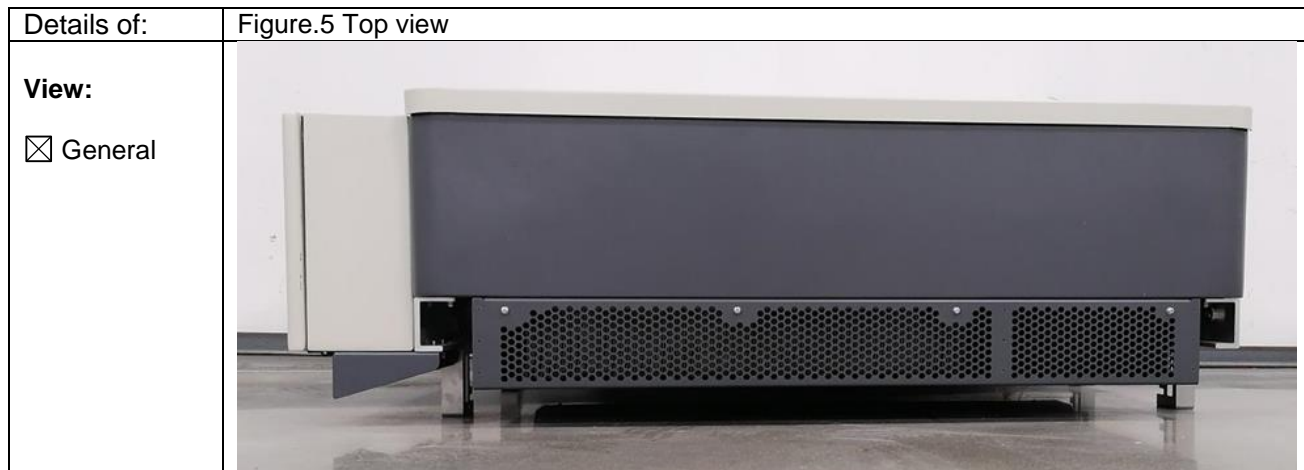

Attachment

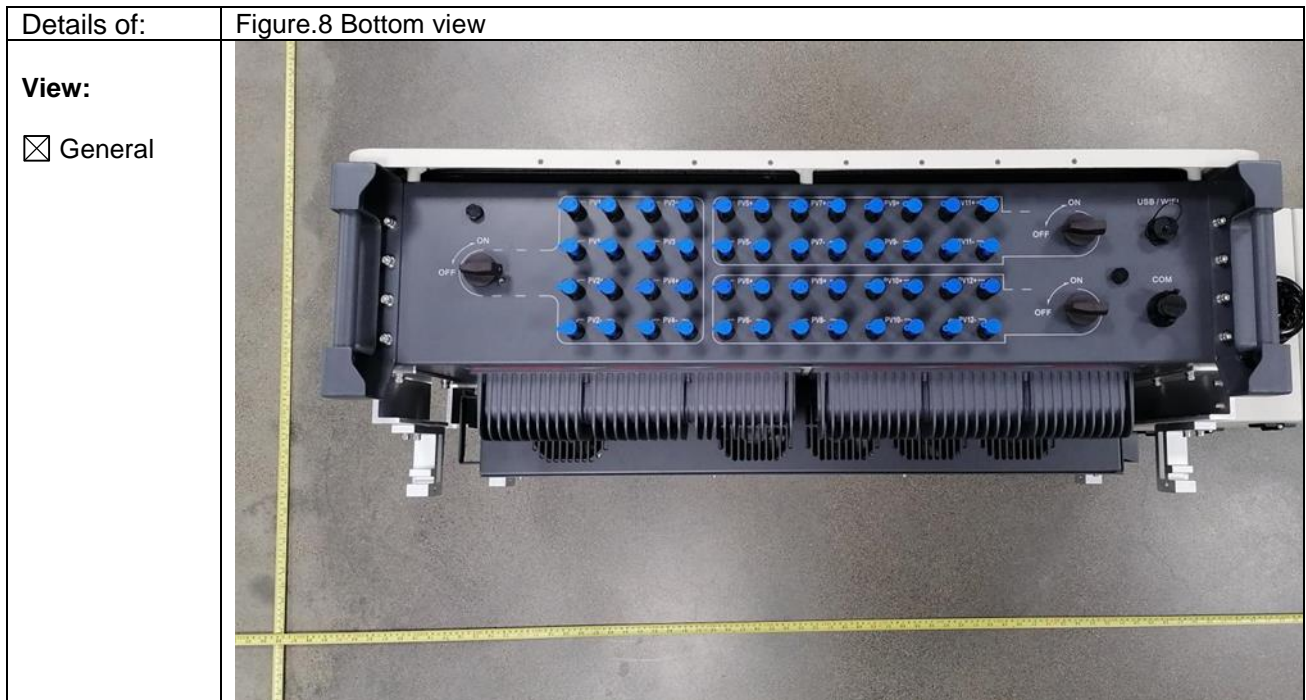

# Attachment

Details of:	Figure.10 Cover board
<b>View:</b> <input checked="" type="checkbox"/> Internal view	

Details of:	Figure.11 Remove cover board
<b>View:</b> <input checked="" type="checkbox"/> Internal view	

**Attachment**

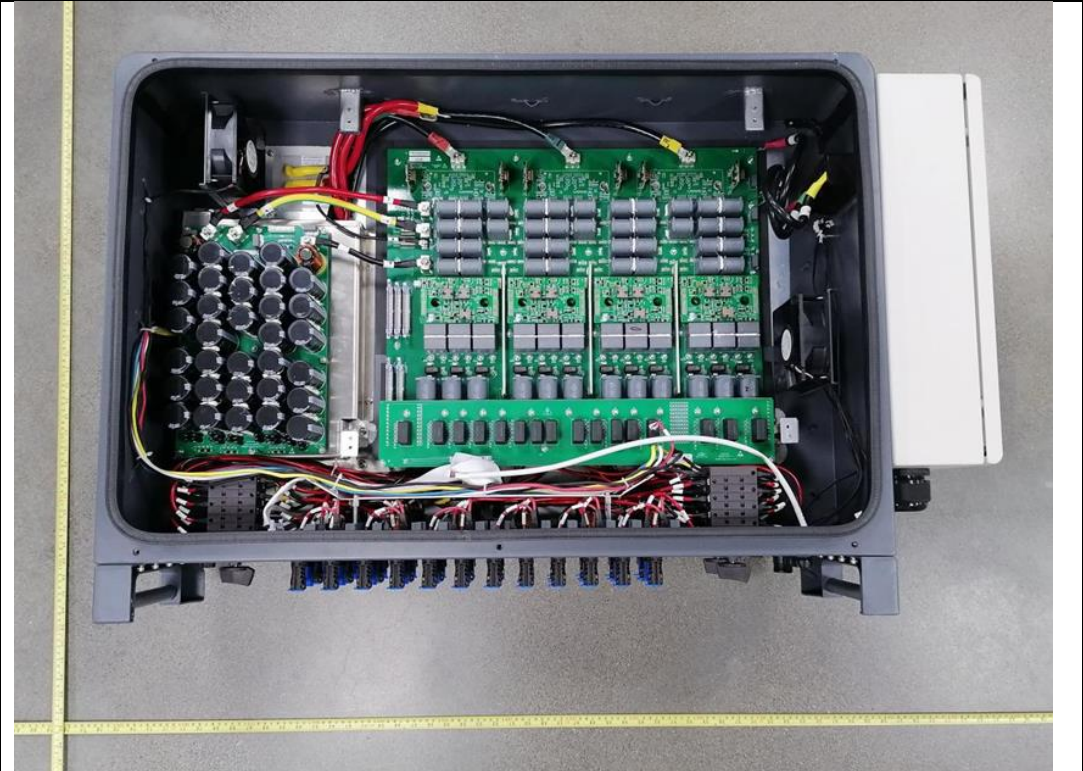
<p>Details of:</p>	<p>Figure.12 Remove Control board, Fan board, Output board, Com board</p>
<p><b>View:</b></p> <p><input checked="" type="checkbox"/> Internal view</p>	

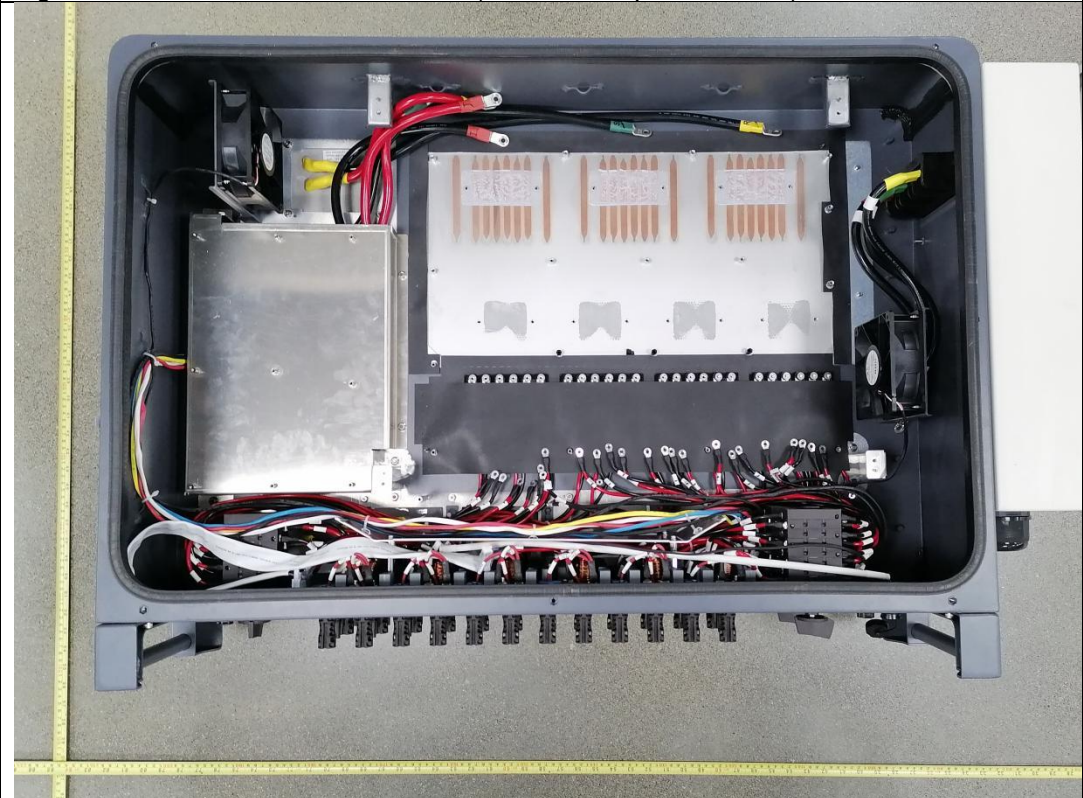
<p>Details of:</p>	<p>Figure.13 Remove base PCB boards (leave Black plastic sheet)</p>
<p><b>View:</b></p> <p><input checked="" type="checkbox"/> Internal view</p>	

**Attachment**

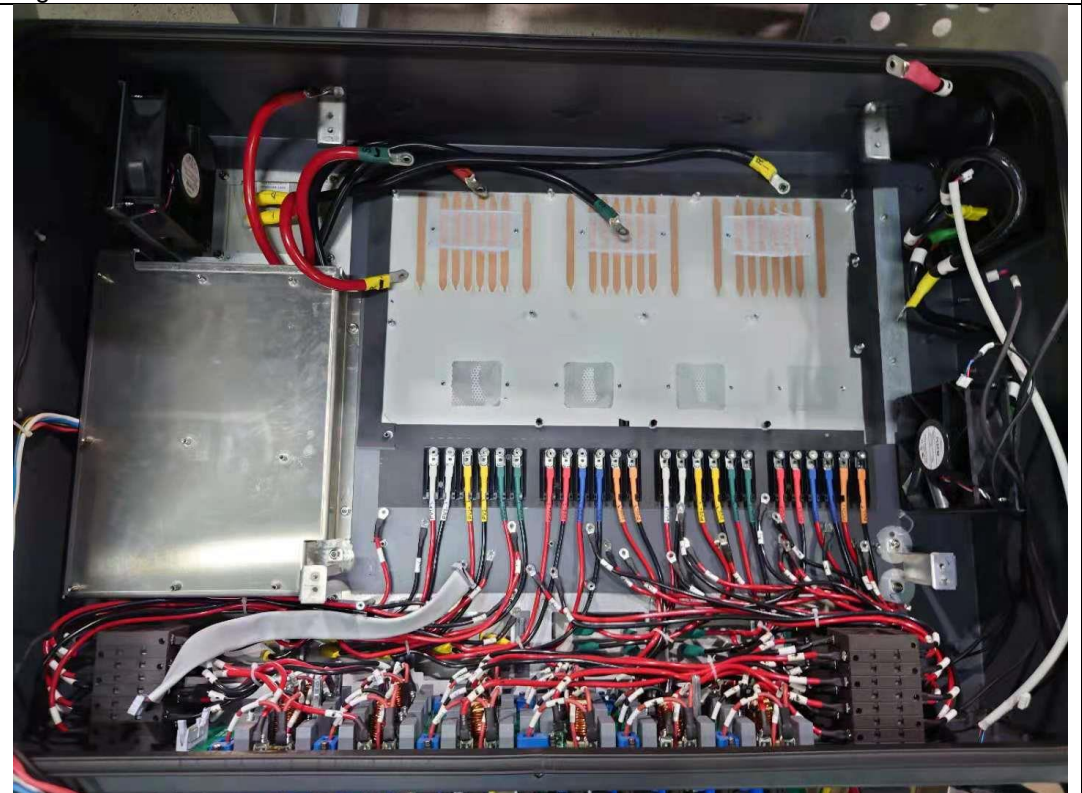
<p>Details of:</p>	<p>Figure.14 Remove base PCB boards</p>
<p><b>View:</b></p> <p><input checked="" type="checkbox"/> Internal view</p>	

<p>Details of:</p>	<p>Figure.15 AC connector</p>
<p><b>View:</b></p> <p><input checked="" type="checkbox"/> Internal view</p>	

## Attachment

Details of:	Figure.16 PE connector	
<b>View:</b> <input checked="" type="checkbox"/> Internal view	 A photograph showing the internal view of a PE connector. The connector is a rectangular metal block with a circular opening on the right side. To the left of the opening is a white plastic component. The metal surface is scratched and shows some wear. In the background, there is a dark metal surface with some faint markings.	

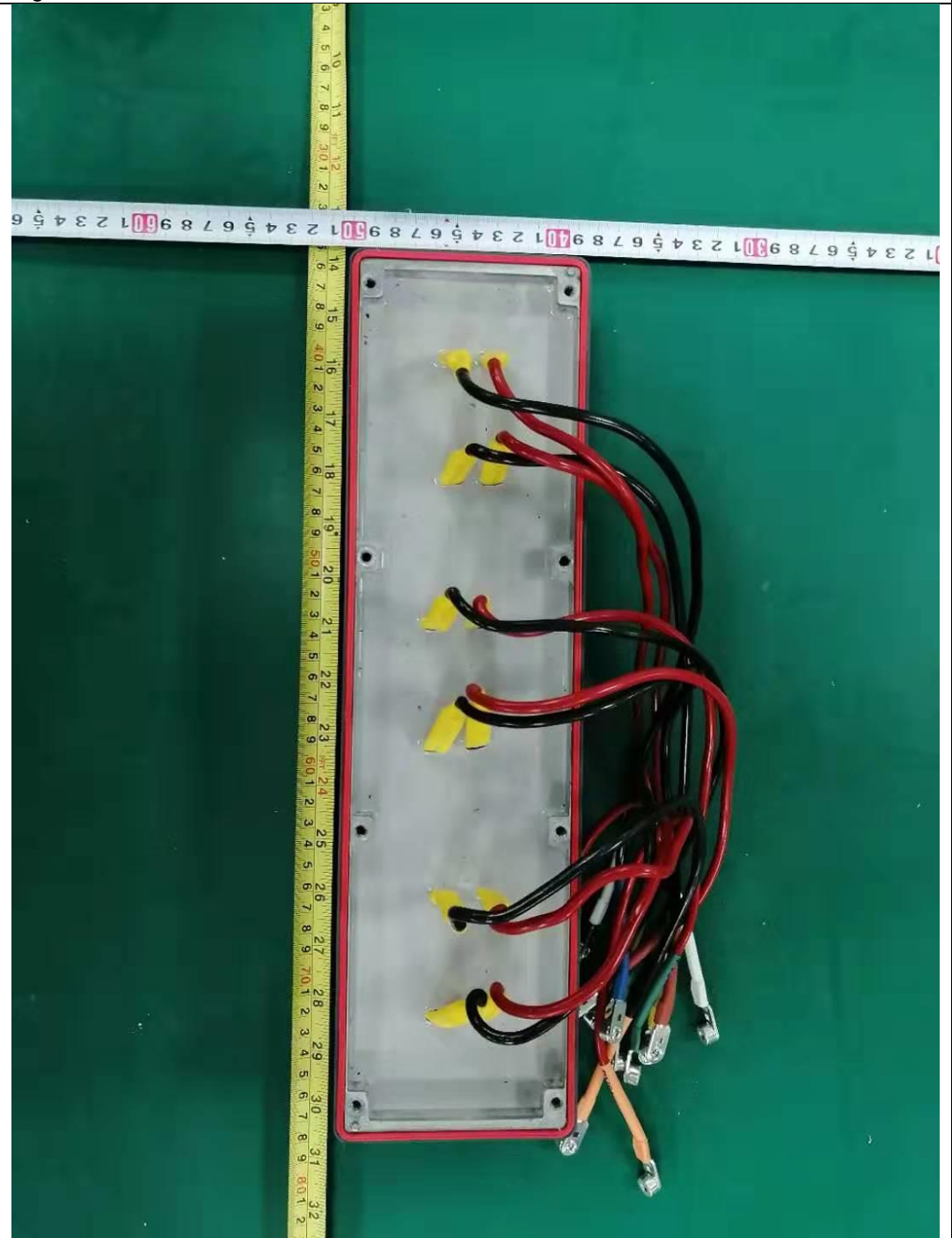

# Attachment

Details of:	Figure.17 Boost Inductor
View: <input checked="" type="checkbox"/> General	

# Attachment

Details of:	Figure.18 INV Inductor
View: <input checked="" type="checkbox"/> General	

# Attachment

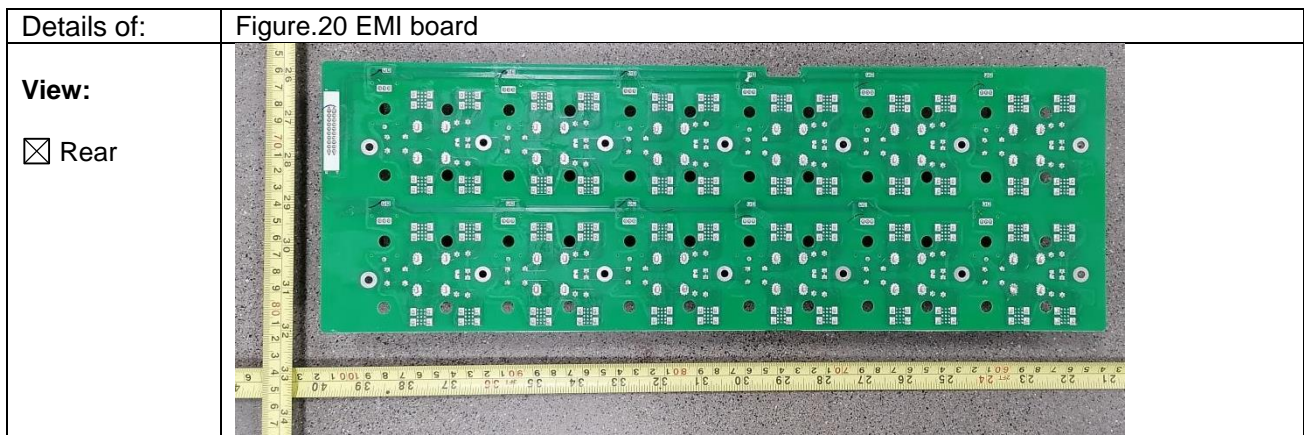
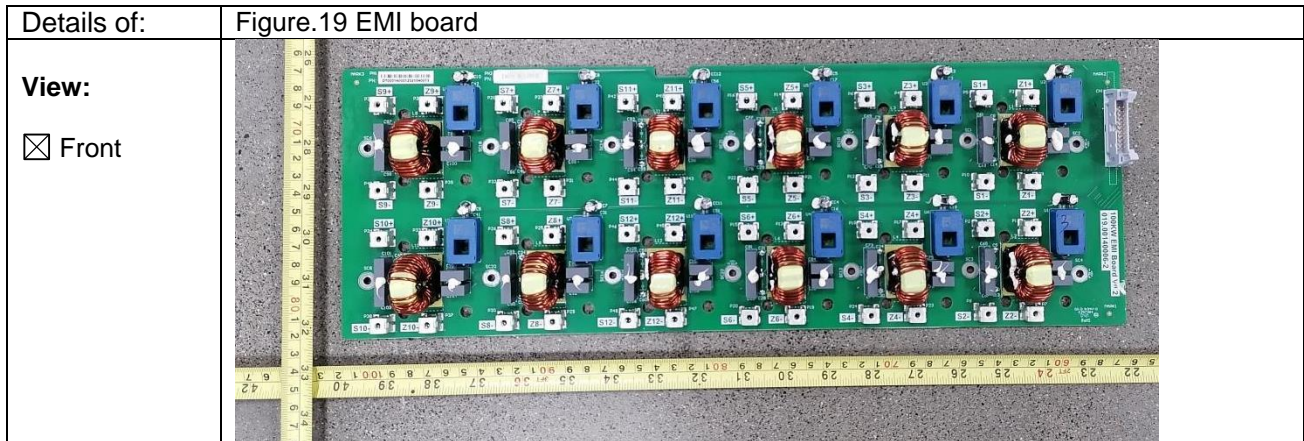

**Attachment**

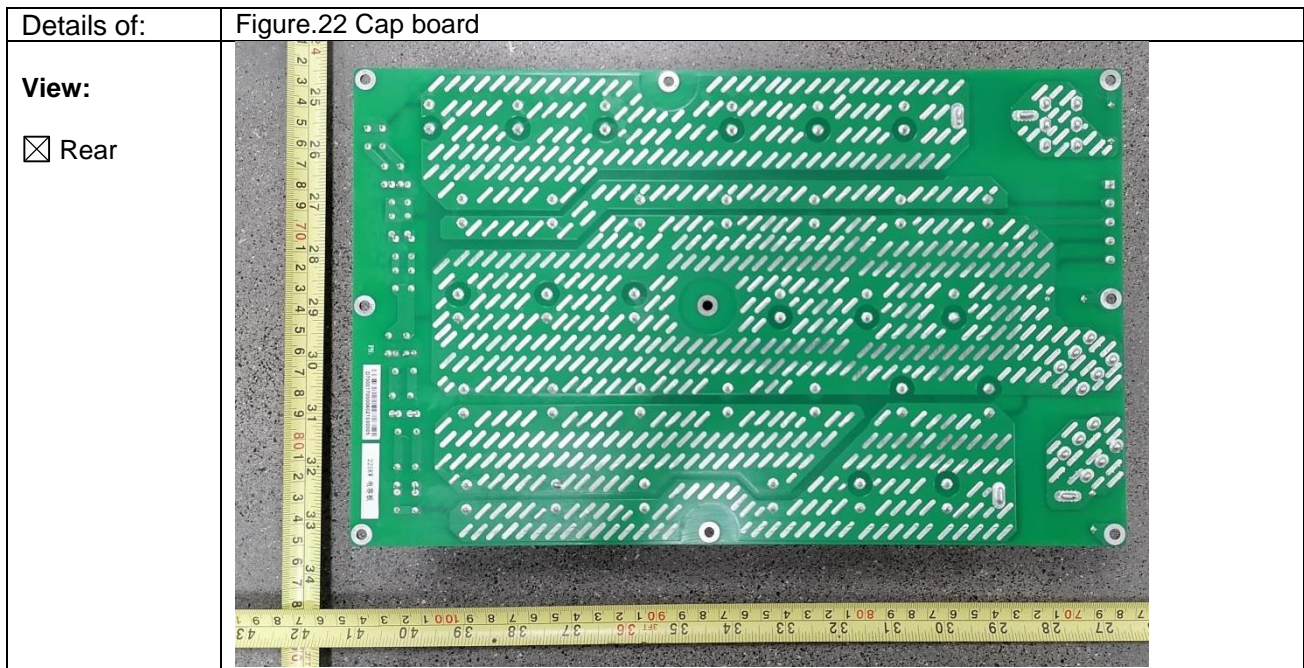
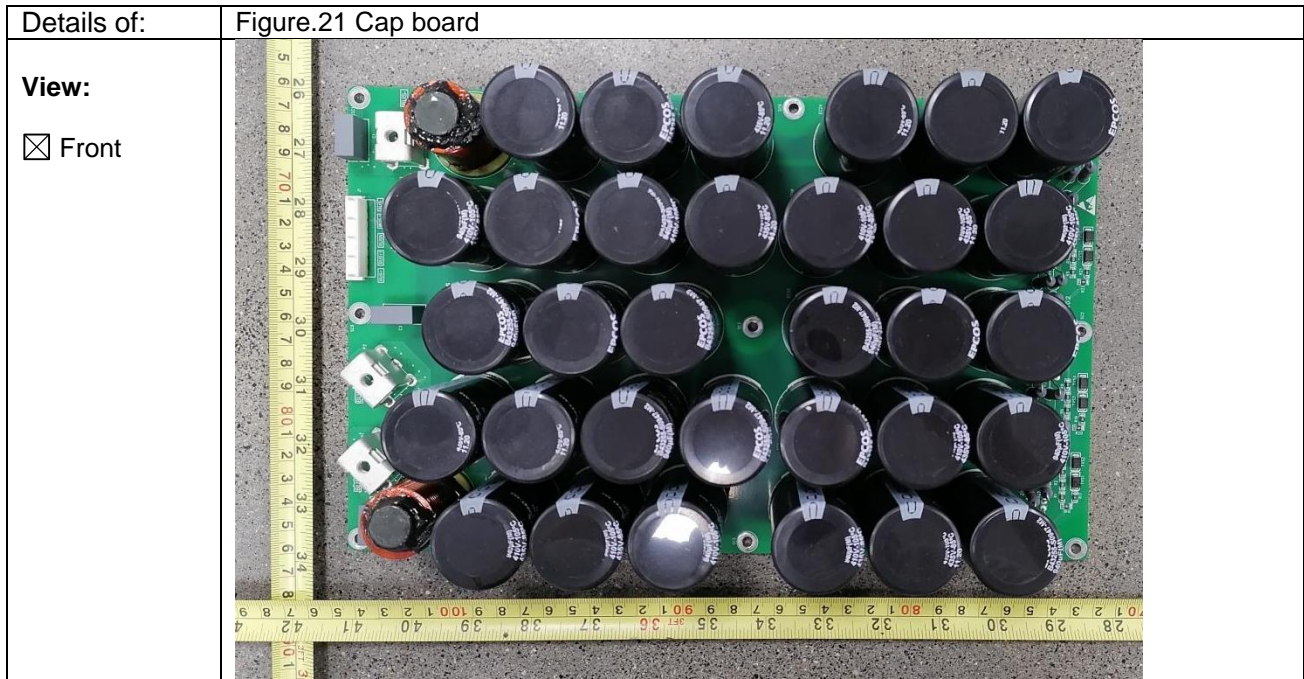

**Attachment**

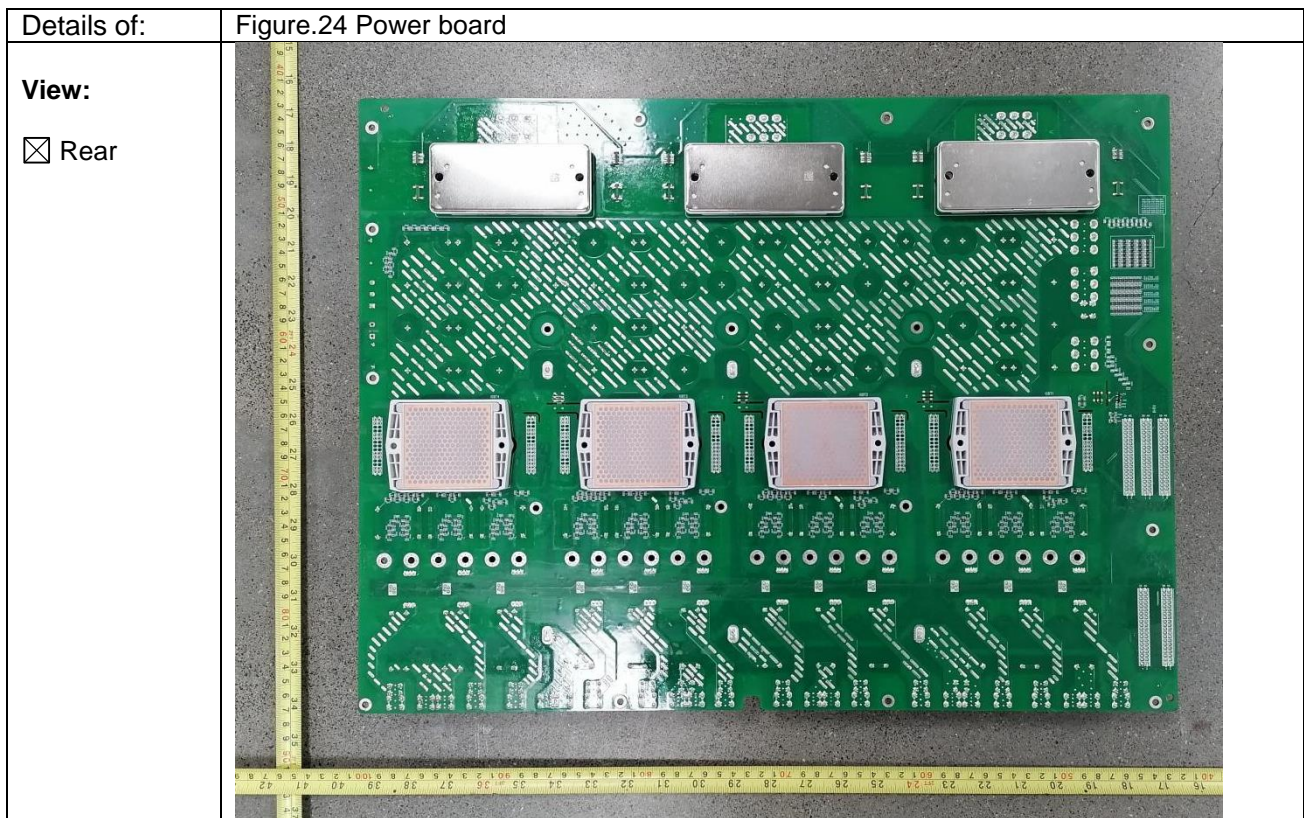
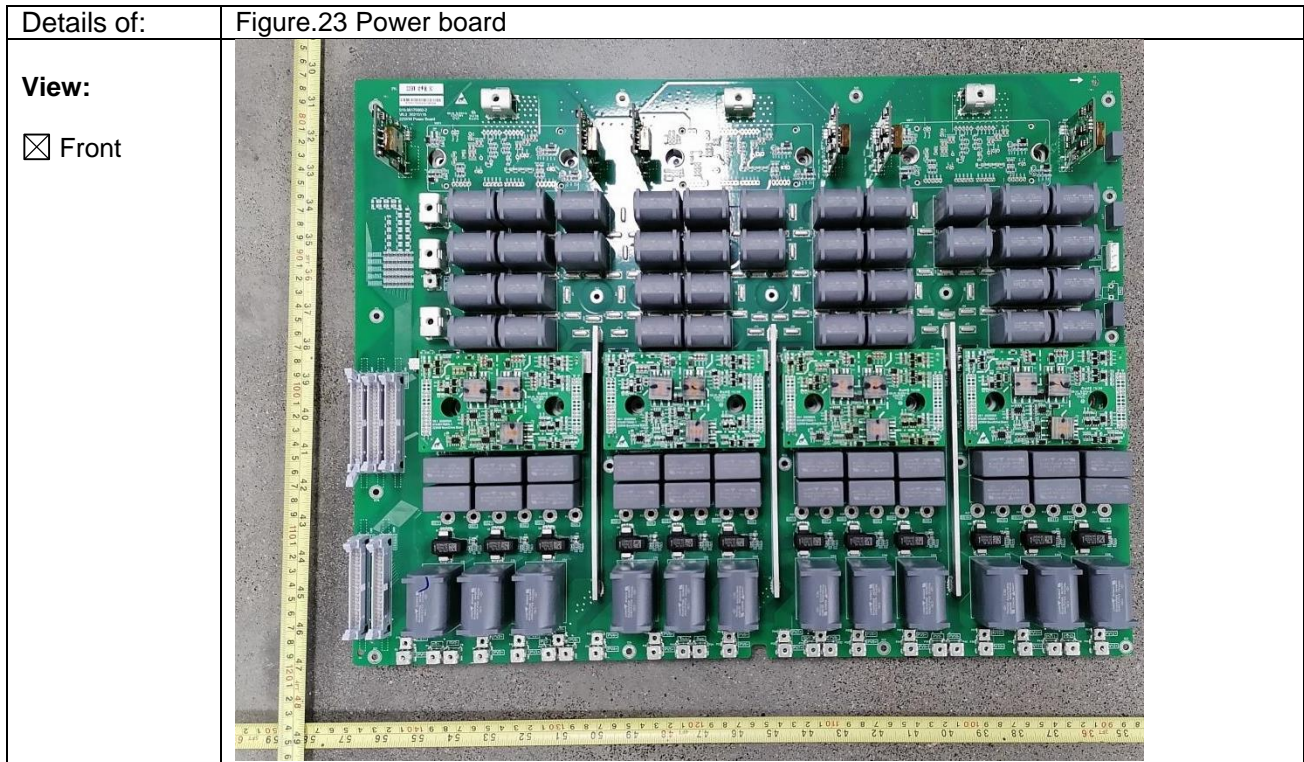

Attachment

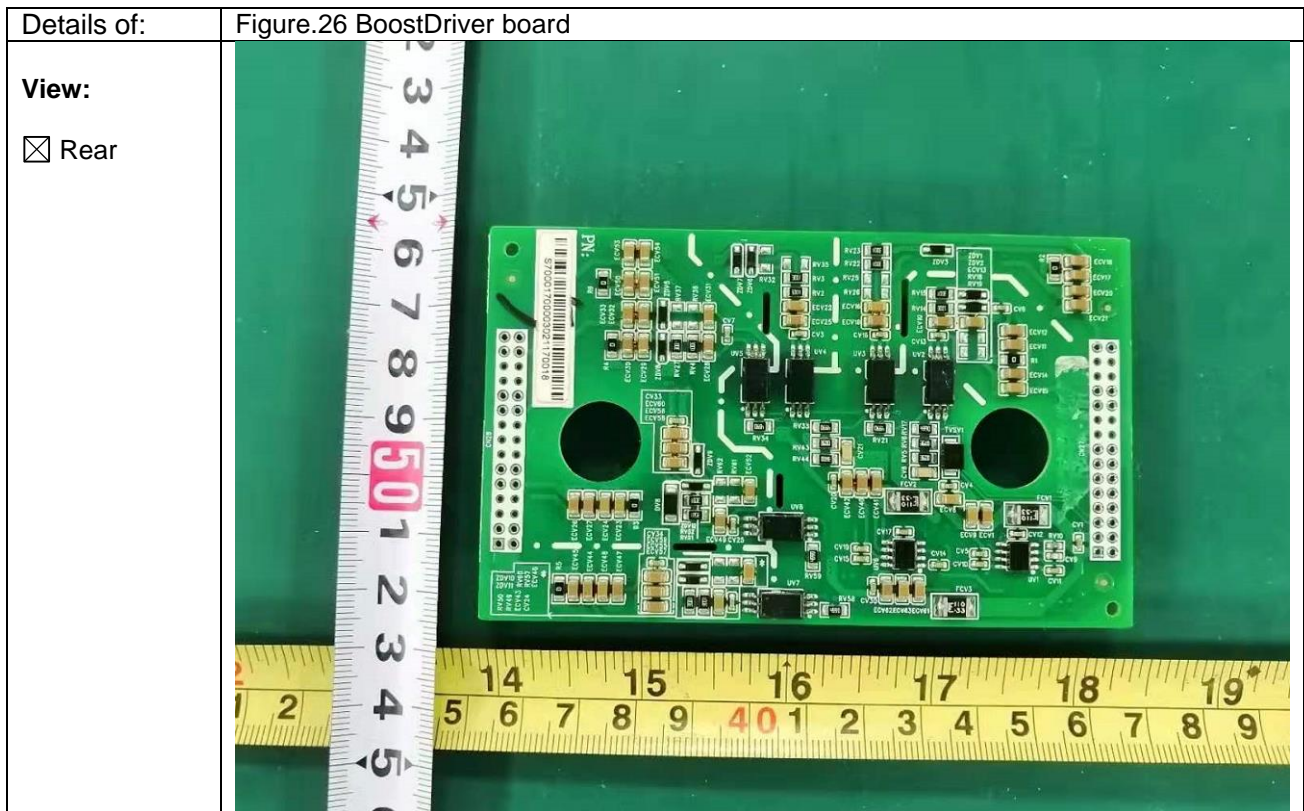
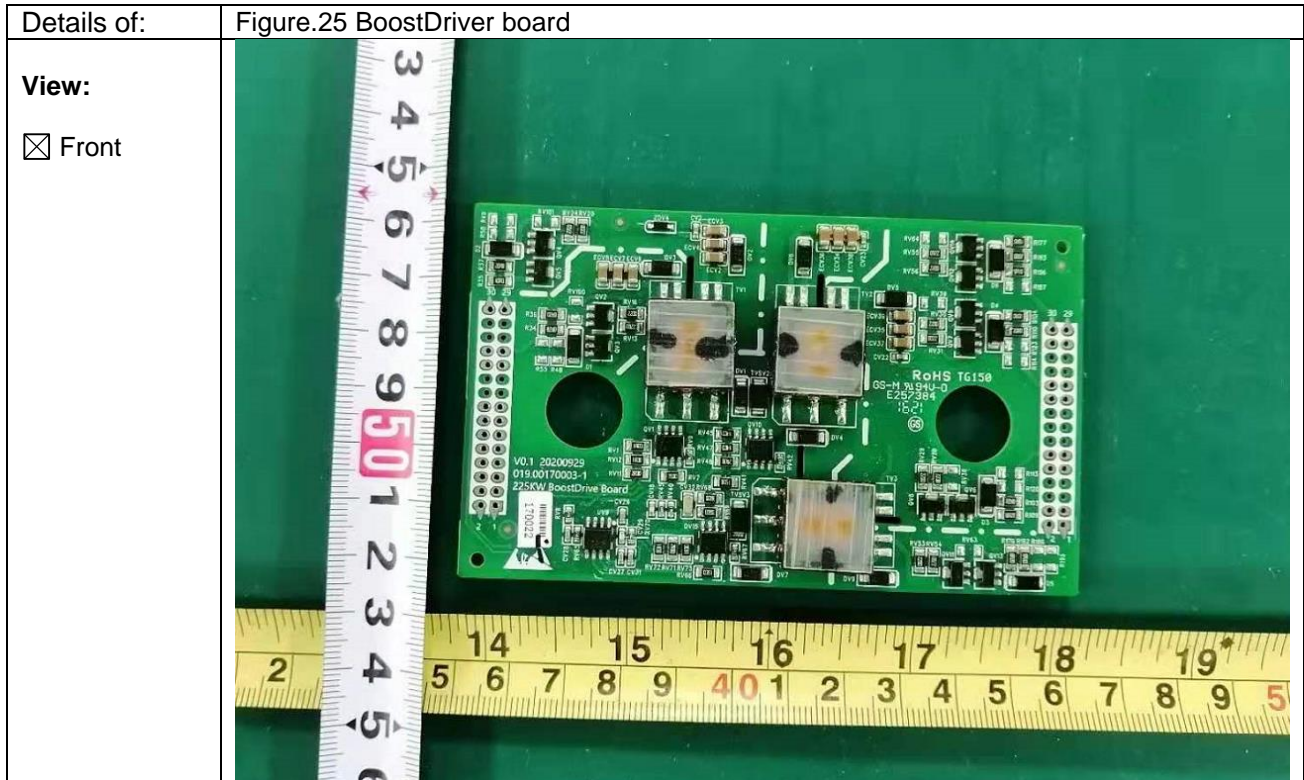

# Attachment

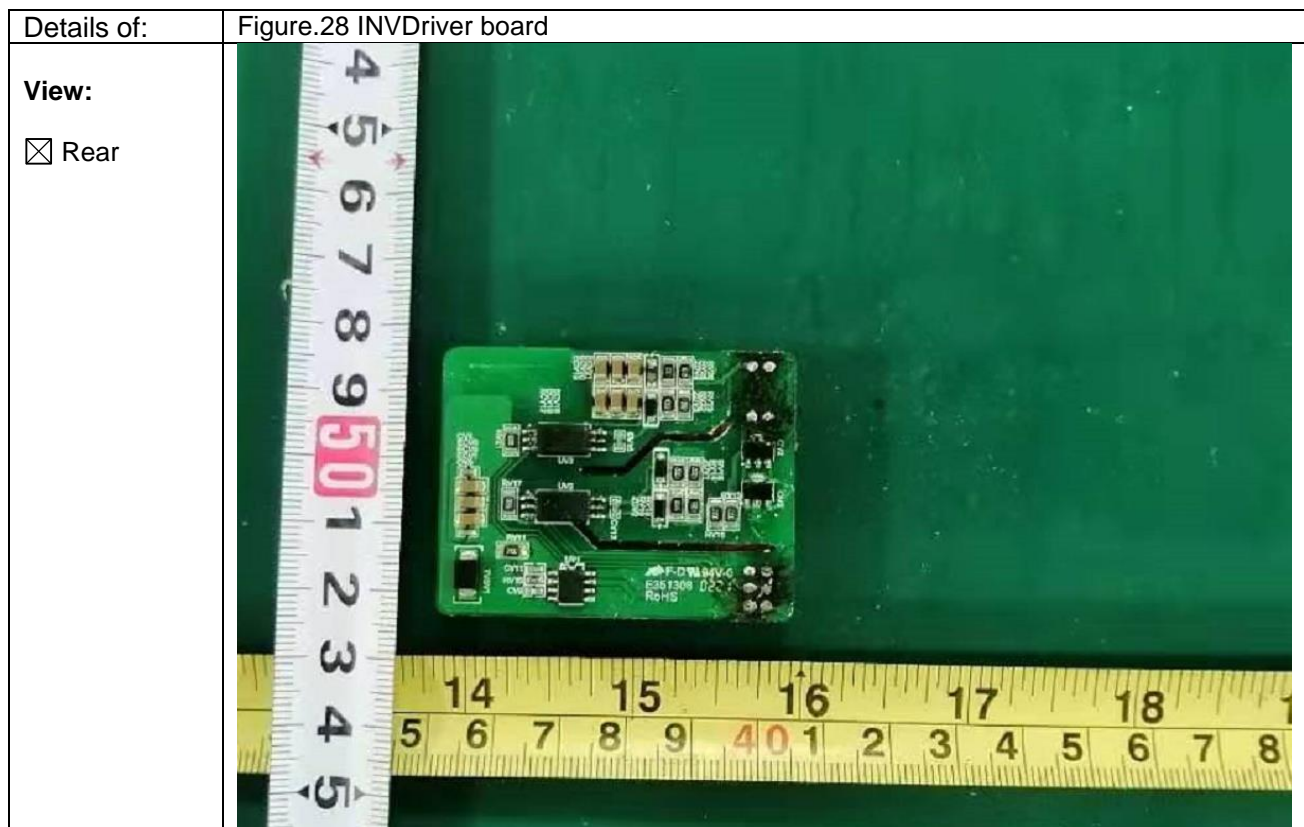
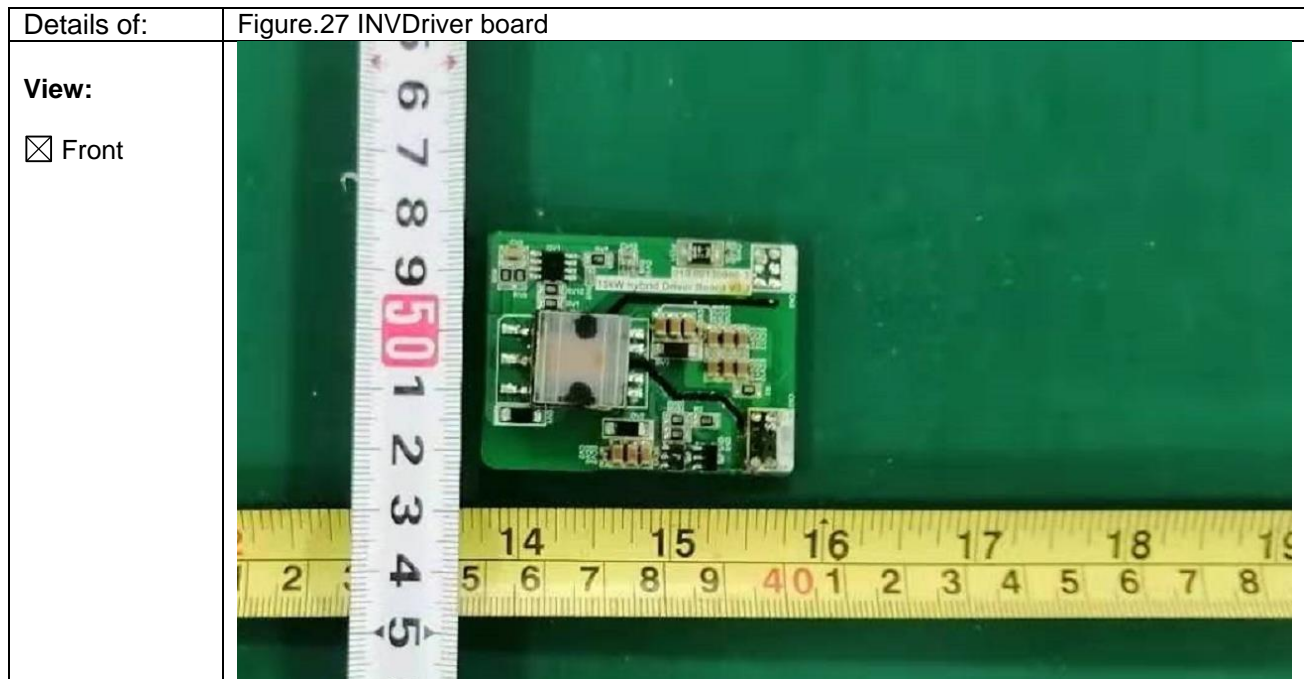

**Attachment**

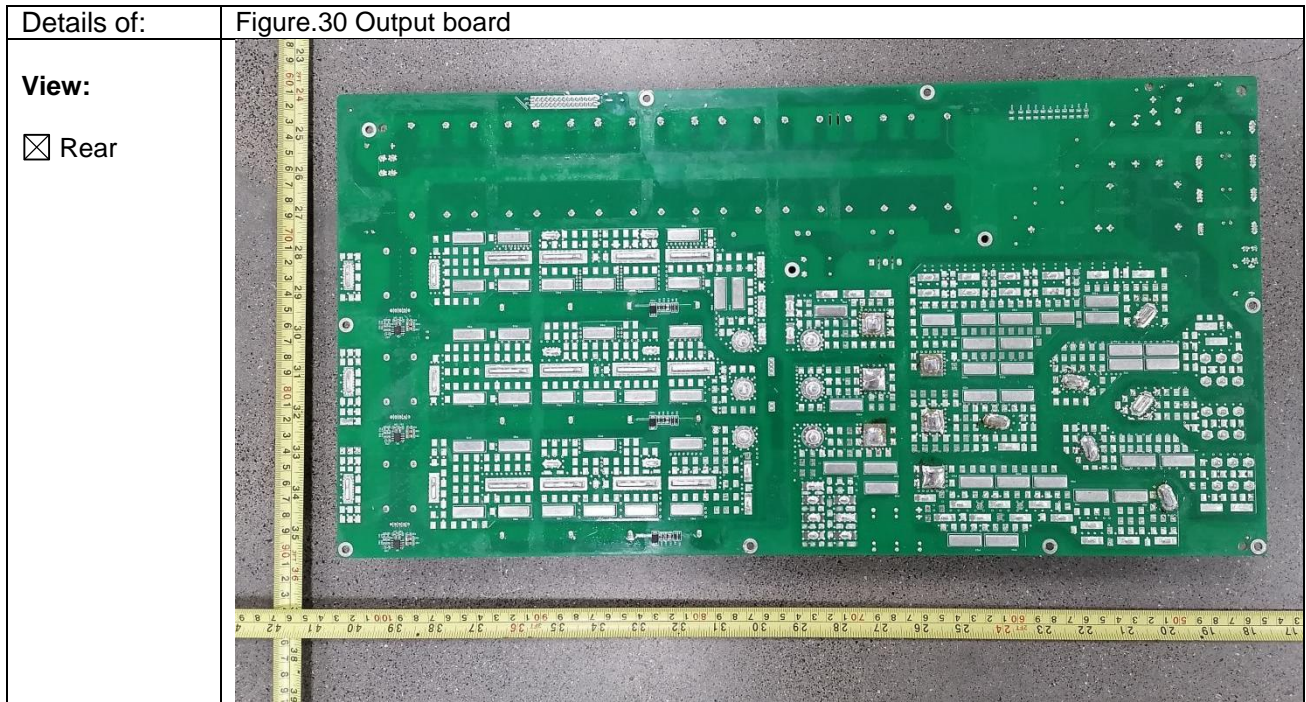
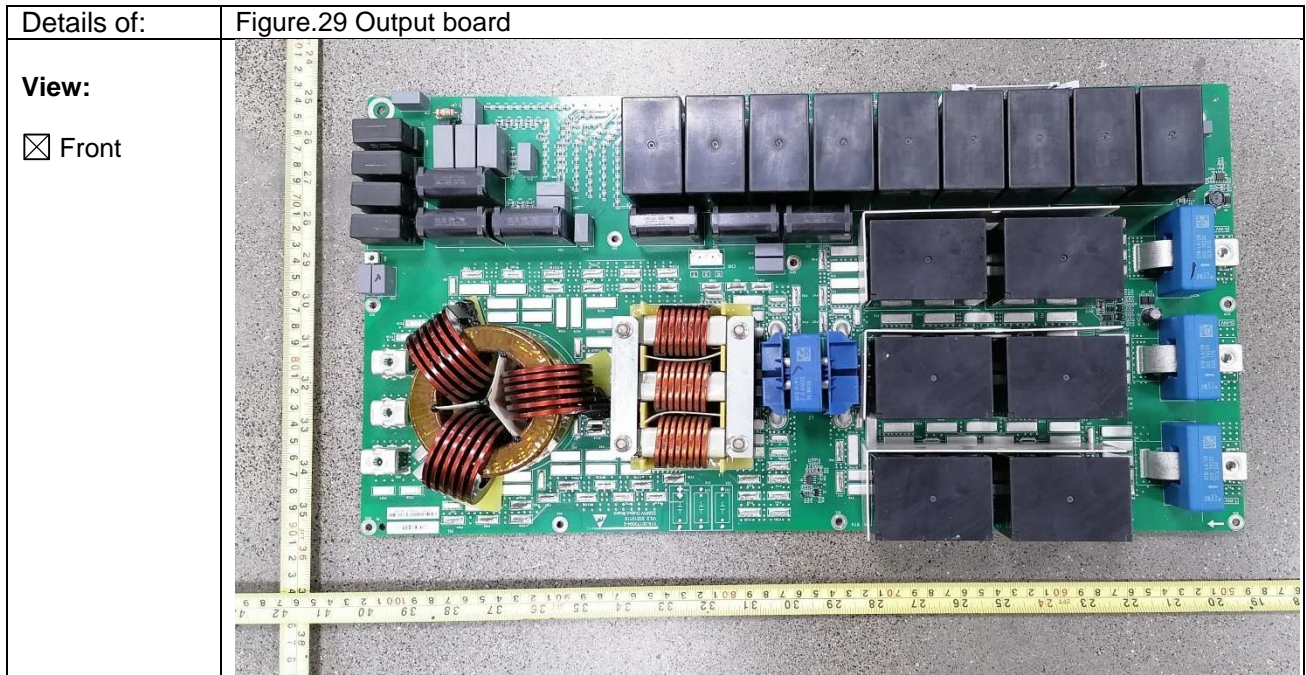



**Attachment**

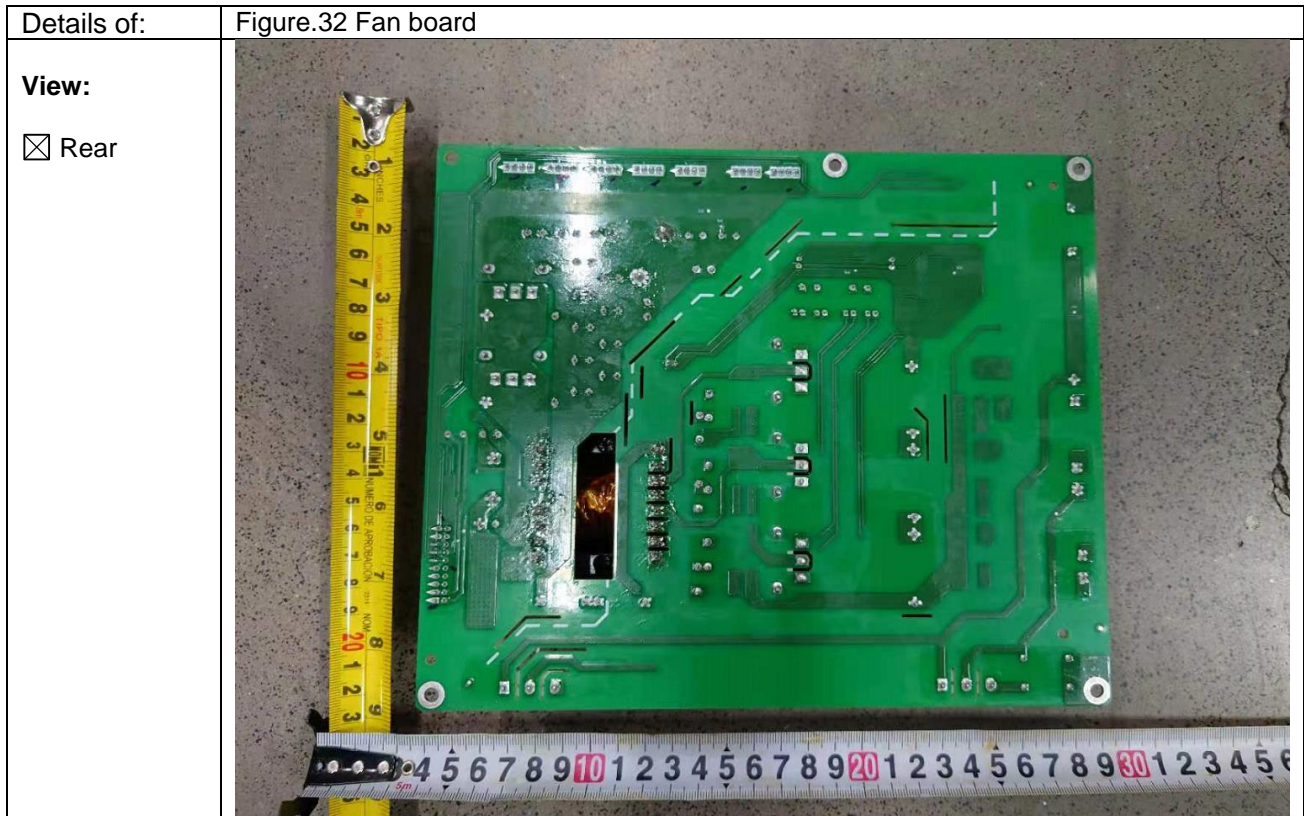
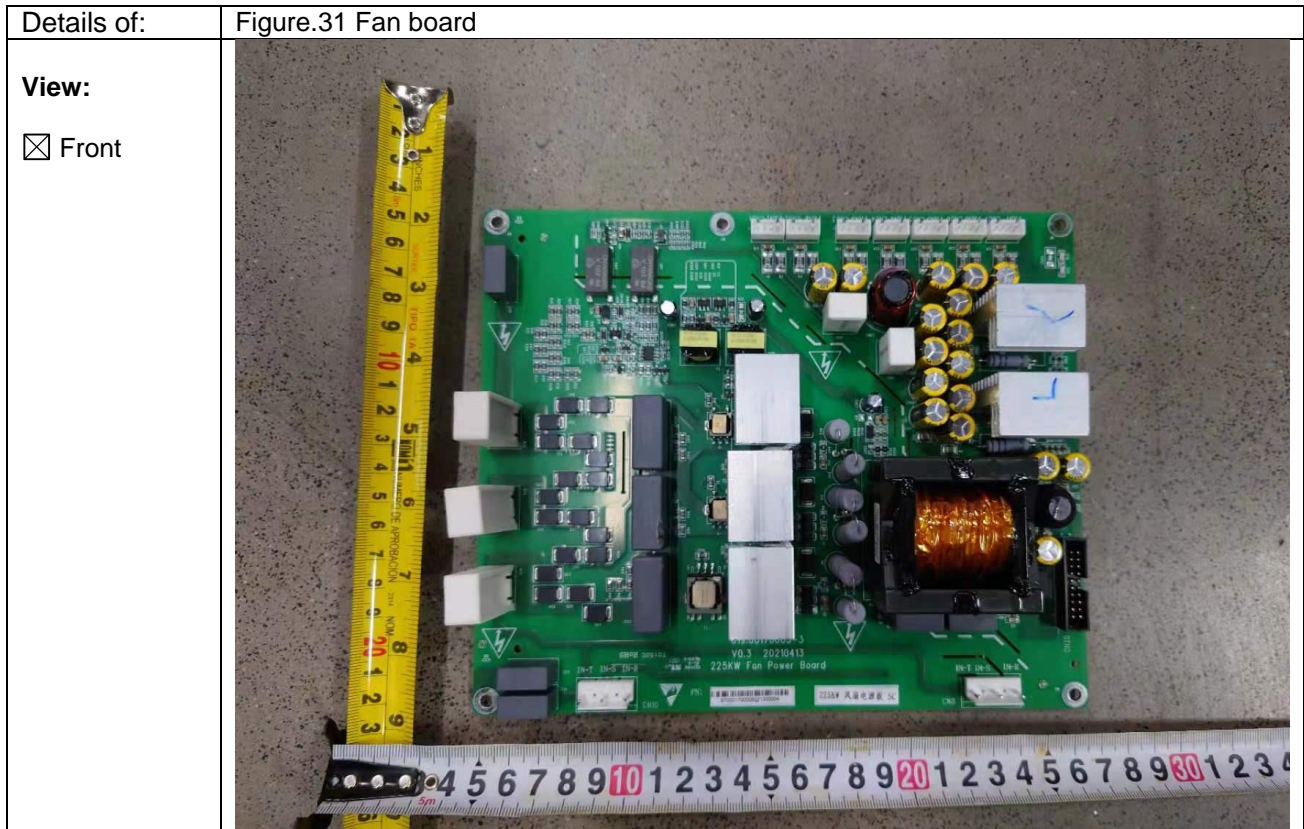

Attachment

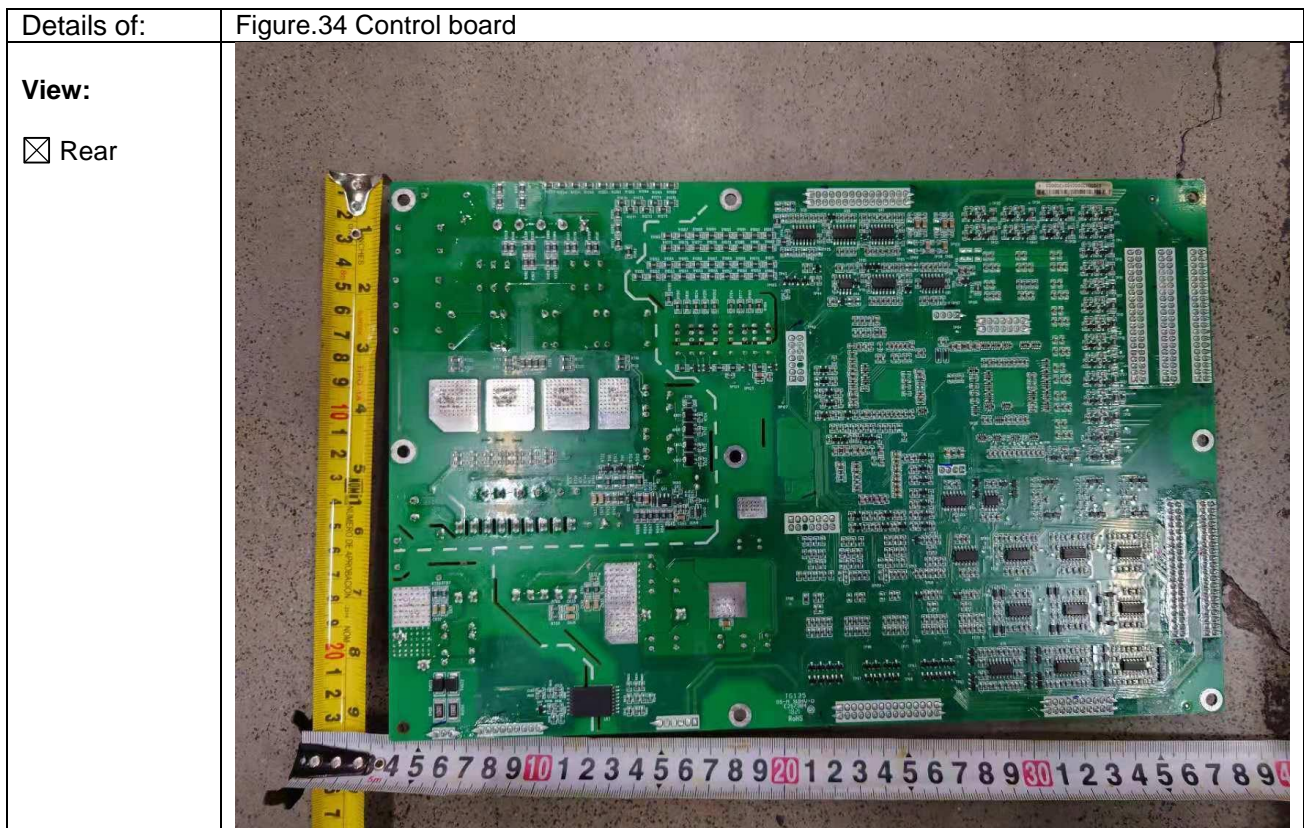
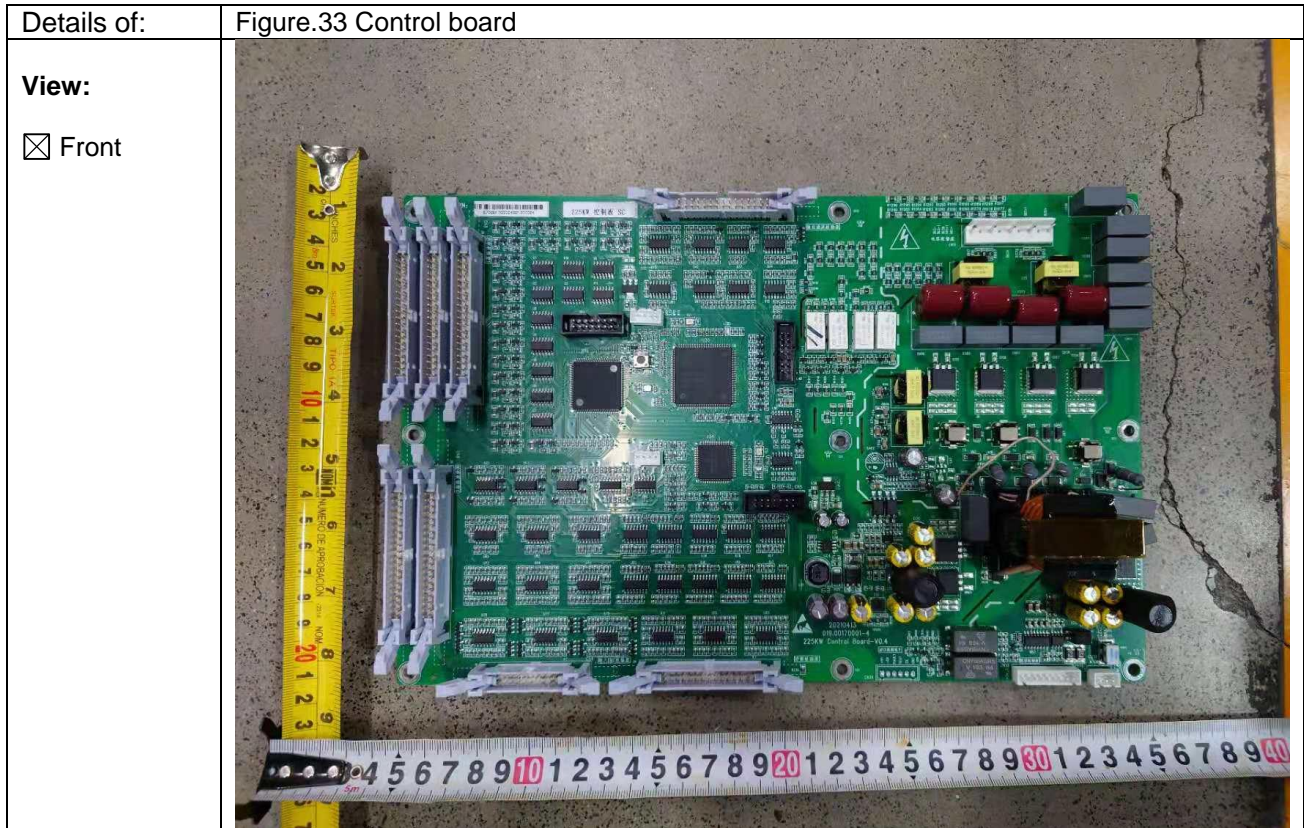

# Attachment

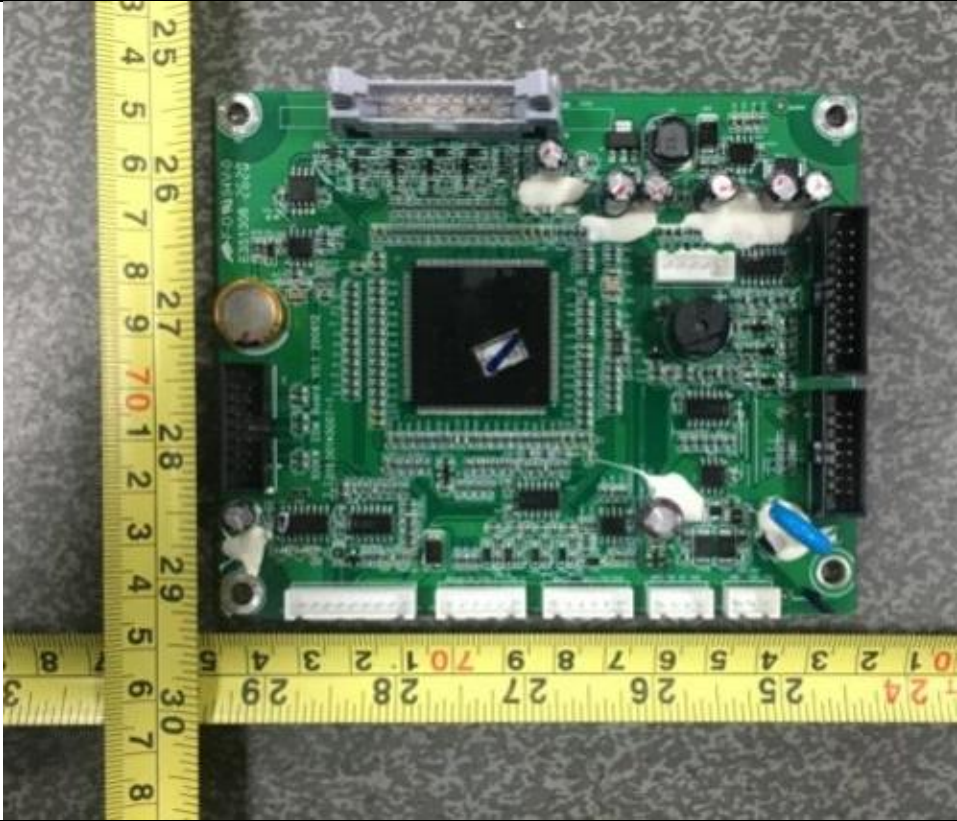
Details of:	Figure.35 Com board	
View: <input checked="" type="checkbox"/> Front		

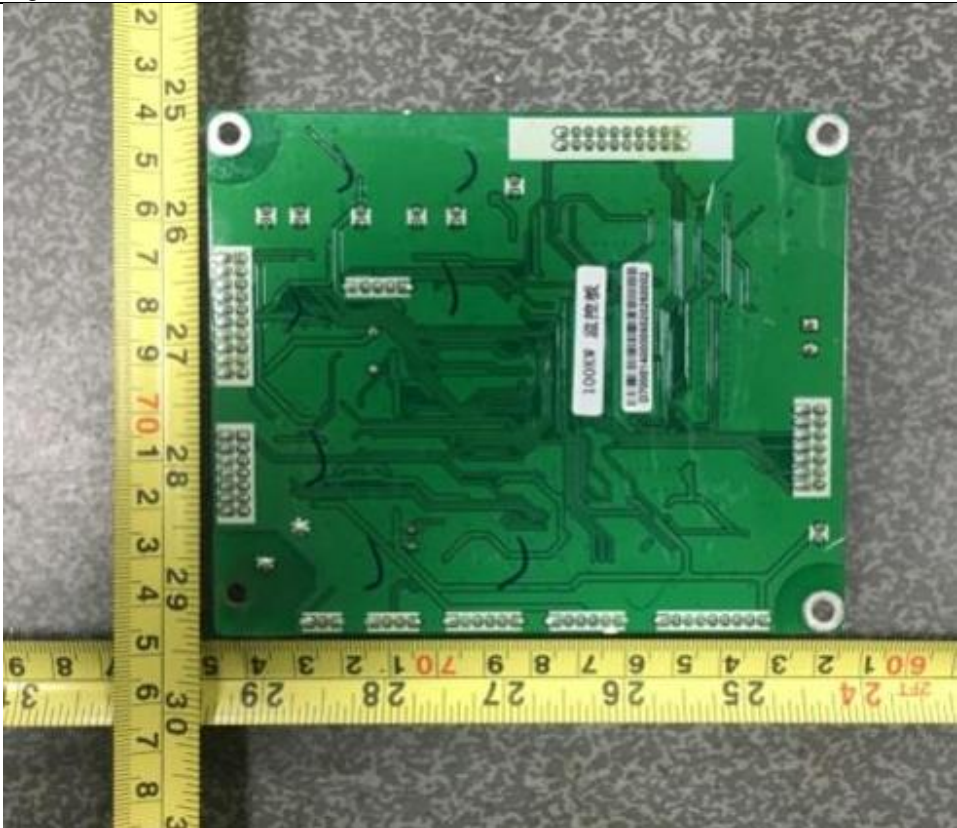
Details of:	Figure.36 Com board	
View: <input checked="" type="checkbox"/> Rear		

# Attachment

Details of:	Figure.37 LED board	
<b>View:</b> <input checked="" type="checkbox"/> Front		

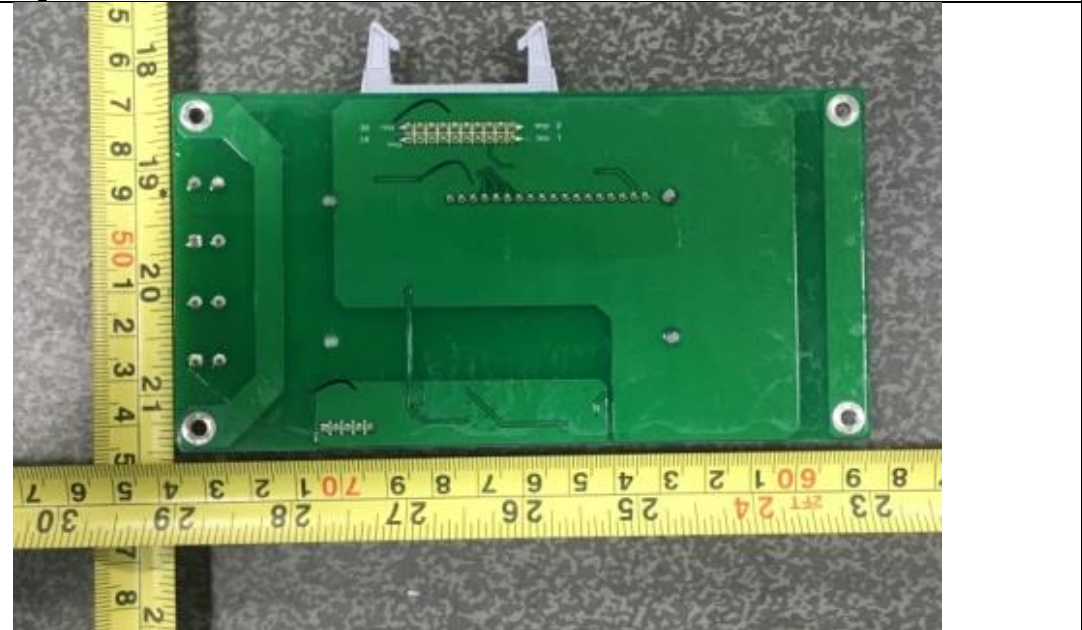
Details of:	Figure.38 LED board	
<b>View:</b> <input checked="" type="checkbox"/> Rear		

# Attachment

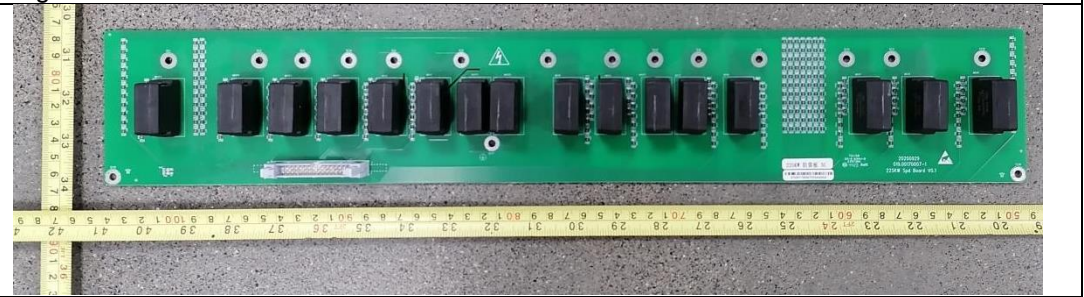
Details of:	Figure.39 SPD board
<b>View:</b> <input checked="" type="checkbox"/> Front	

Details of:	Figure.40 SPD board
<b>View:</b> <input checked="" type="checkbox"/> Rear	