

<p>TEST REPORT</p> <p>France_ UTE C 15-712-1: 2013</p> <p>Low Voltage Electrical Installations Practical Guide</p> <p>Photovoltaic installations without storage and connected to the public distribution network</p>	
<p>Report reference No. : 190411093GZU-001</p> <p>Tested by (printed name and signature) : Sunny Lin Engineer</p> <p>Approved by (printed name and signature) : Jason Fu Technical Team Leader</p> <p>Date of issue : 11 Mar 2020 27 pages</p>	<p><i>Sunny Lin</i></p> <p><i>Jason Fu</i></p>
<p>Testing Laboratory Name : Intertek Testing Services Shenzhen Ltd. Guangzhou Branch</p> <p>Address : Block E, No.7-2 Guang Dong Software Science Park, Caipin Road, Guangzhou Science City, GETDD, Guangzhou, China</p> <p>Testing location : Same as above</p> <p>Address : Same as above</p>	
<p>Applicant's Name : Shenzhen SOFAR SOLAR Co., Ltd.</p> <p>Address : 401, Building 4, AnTongDa Industrial Park, District 68, XingDong Community, XinAn Street, BaoAn District, Shenzhen, China</p>	
<p>Test specification</p> <p>Standard..... : France_UTE_C_15_712-1:July 2013 (in conjunction with DIN V VDE V 0126-1-1 VFR 2014)</p> <p>Test procedure : Type approval</p> <p>Non-standard test method : N/A</p>	
<p>Test Report Form No. : France_UTE_C_15_712b</p> <p>TRF originator : Intertek</p> <p>Master TRF : dated 2018-04</p>	
<p>Test item description : Solar Grid-tied Inverter</p> <p>Trademark : SOFAR SOLAR</p> <p>Manufacturer : Same as Applicant</p>	
<p>Model and/or type reference : SOFAR 10000TL-G2, SOFAR 12000TL-G2, SOFAR 15000TL-G2</p>	

Rating(s)..... :	Model	SOFAR 10000TL-G2	SOFAR 12000TL-G2	SOFAR 15000TL-G2
	Max.PV voltage	1000 d.c.V		
	PV MPPT voltage range	160-960 d.c.V		
	Max.input current	21 /11 d.c.A		
	PV Isc	30/15 d.c.A		
	Max.output power	10000W	12000W	15000W
	Max.apparent power	11000VA	13200VA	16500VA
	Nominal output voltage	3/N/PE, 230 /400 a.cV		
	Max.output current	3x16.5 a.c.A	3x20.0 a.c.A	3x24.0 a.c.A
	Nominal output Frequency	50 Hz		
	Power factor range	0.8Leading – 0.8 lagging		
	Inverter technology	Non-isolated		
	Safety level	Class I		
	Ingress Protection	IP 65		
	Operation Ambient Temperature	-25°C - +60°C		
Software Version	V1.30			









Summary of testing:

The sample(s) tested complied with the default type test requirement of France_UTE_C_15_712-1: July 2013

Copy of marking plate

The artwork below may be only a draft. The use of certification marks on a product must be authorized by the respective NCBs that own these marks

Solar Grid-tied Inverter

Model No:	SOFAR 15000TL-G2
Max.DC Input Voltage	1000V
Operating MPPT Voltage Range	160~960V
Max. Input Current	21A/11A
Max. PV Isc	30A/15A
Nominal Grid Voltage	3/N/PE,230/400Vac
Max.Output Current	3x24A
Nominal Grid Frequency	50/60Hz
Nominal Output Power	15000W
Max.Output Power	16500VA
Power Factor	>0.99(adjustable+/-0.8)
Ingress Protection	IP65
Operating Temperature Range	-25°C~ +60°C
Protective Class	Class I
Topology	Non-isolated
Made In China	
Manufacturer : Shenzhen SOFAR SOLAR Co.,Ltd. Address : 401, Building 4, AnTongDa Industrial Park, District 68, XingDong Community,XinAn Street, BaoAn District, Shenzhen, China IEC62109-1,IEC62109-2,NB-T 32004	
       	

Note:

1. The above markings are the minimum requirements required by the safety standard. For the final production samples, the additional markings which do not give rise to misunderstanding may be added.
2. Label is attached on the side surface of enclosure and visible after installation.
3. Other labels are identical to above, except the model name and ratings

Test case verdicts

Test case does not apply to the test object : N/A

Test item does meet the requirement: P(ass)

Test item does not meet the requirement ...: F(ail)

Testing

Date of receipt of test item: 02 Mar 2020

Date(s) of performance of test: 02 Mar 2020 to 10 Mar 2020

General remarks

The test results presented in this report relate only to the object tested.
This report shall not be reproduced, except in full, without the written approval of the Issuing testing laboratory.
"(See Enclosure #)" refers to additional information appended to the report.
"(See appended table)" refers to a table appended to the report.

Throughout this report a point is used as the decimal separator.

When determining the test conclusion, the Measurement Uncertainty of test has been considered.

This report is for the exclusive use of Intertek's Client and is provided pursuant to the agreement between Intertek and its Client. Intertek's responsibility and liability are limited to the terms and conditions of the agreement. Intertek assumes no liability to any party, other than to the Client in accordance with the agreement, for any loss, expense or damage occasioned by the use of this report. Only the Client is authorized to permit copying or distribution of this report and then only in its entirety. Any use of the Intertek name or one of its marks for the sale or advertisement of the tested material, product or service must first be approved in writing by Intertek. The observations and test results in this report are relevant only to the sample tested. This report by itself does not imply that the material, product, or service is or has ever been under an Intertek certification program. The test report only allows to be revised only within the report defined retention period unless standard or regulation was withdrawn or invalid.

This report should be used together with report No. 190411093GZU-002

General product information:

The unit is a three-phases non-isolated PV Grid-tied inverter, it can convert the high PV voltage to Grid voltage and feed into Grid network.

The unit is providing EMI filtering at the PV side and AC side. It does provide basic insulation from PV side to Grid.

The unit has two controllers. The master controller A monitor the invert statue; measure the PV voltage and current, bus voltage, AC voltage, current, GFCI and frequency, also communicate with the slave controller B

The slave controller B monitor AC voltage, current, frequency, GFCI and communicate with the master controller A

The relays are designed to redundant structure that controlled by separately.

The master controller and slave controller are used together to control relay open or close, if the single fault on one controller, the other controller can be capable to open the relay, so that still providing safety means.

The topology diagram as following:

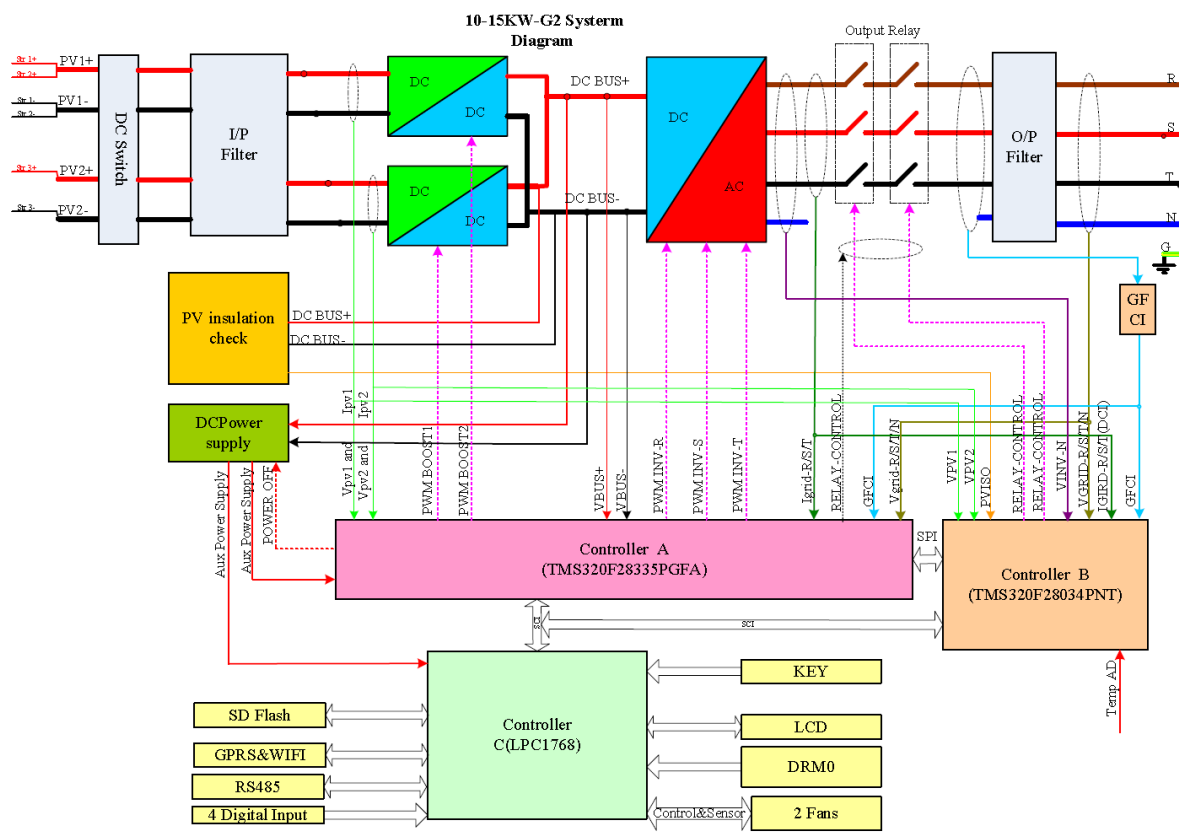

Model differences:

The model SOFAR 10000TL-G2, SOFAR 12000TL-G2 and SOFAR 15000TL-G2 are completely identical, except output power derating in software.

The only differences on hardware between the models SOFAR 10000TL-G2, SOFAR 12000TL-G2 and SOFAR 15000TL-G2 are below:

The main output inductor is NPS226060*2+NPF226060*2, 2.0Φ*2P /37Ts L=756μH for model SOFAR 15000TL-G2 while it's NPS226060*2+NPF226060*1, 2.0Φ*2P*42Ts L=0.73mH for model SOFAR 10000TL-G2, SOFAR 12000TL-G2

Factory information:

Dongguan SOFAR SOLAR Co., Ltd

1F-6F, Building E, No.1 JinQi Road, BiHu Industrial Park, Wulian Village, Fenggang Town, Dongguan City

UTE C 15-712-1			
Cl.	Requirement - Test	Result	Verdict
5	Description of PV installations (informative)		-
6	Earthing of the installation	Shall be considered in the end installation	N/A
6.1	<p>Diagrams of the earth connections of the alternating current part</p> <p>The earthing system has been produced in accordance with the requirements of NF C 15-100</p> <p>When the PV installation is connected to the public low-voltage distribution network in general, the earthing system is of the TT type for which the neutral conductor of the installations connected to the network must not be earthed.</p> <p>When the PV installation is connected to the public MV distribution network via a HV / LV transformer, the earthing scheme is TN or IT type.</p>	Shall be considered in the end installation	N/A
6.2	<p>Functional grounding of a polarity of the direct current section</p> <p>In a PV installation, the indirect contact protection provisions do not use the principle of earth connection schemes. The direct current portion is made according to the rules of class II or equivalent insulation</p>	Shall be considered in the end installation	N/A
6.3	Earthing of conductive masses and elements	Shall be considered in the end installation	N/A
6.3.1	<p>Direct current part</p> <p>To minimise the effects of induced overvoltages, the metal structures of the modules and the metal support structures (including the metal cable runs) must be connected to equipotential bonding, which in turn is connected to the earth.</p>	Shall be considered in the end installation	N/A
6.3.2	<p>Alternating current part</p> <p>All chassis on the a.c. side must be connected to the earth via a protective conductor that meets the requirements of paragraph 411.3.1.2 and section 5-54 of N F C 15-100.</p> <p>If a transformer is installed outside the inverter (low voltage/low voltage or high voltage/low voltage transformer), equipotential bonding is required between these items of equipment.</p>	Shall be considered in the end installation	N/A
6.3.3	<p>Inverter</p> <p>The inverter body must be connected to the equipotential bonding via a conductor with a minimum cross-section of 6mm² Cu or equivalent and to the protective conductor of the a.c. part.</p>	Shall be considered in the end installation	N/A
7	Protection against electric shock	Shall be considered in the end installation	N/A

UTE C 15-712-1			
Cl.	Requirement - Test	Result	Verdict
7.1	<p>General</p> <p>The PV equipment of the DC section must be considered live even if the AC section is disconnected.</p> <p>The DC voltage to be considered is the U_{ocmax} voltage of the installation.</p>	Shall be considered in the end installation	N/A
7.2	<p>Protection measure by TBTS or PELV on part d.c.</p> <p>The requirements of SELV or PELV are described in article 414 of NF C 15-100 and are specified below:</p> <ul style="list-style-type: none"> - the a.c. portion of the installation is separated by a safety transformer conforming to standard NF EN 61558-2-6 or a safety converter in accordance with standard NF EN 61046, in accordance with 414.3 of NF C 15-100. The safety transformer or safety converter may be integrated in or near the inverter if the connection between the two devices is made with Class II equipment or equivalent insulation. - in PELV, a polarity of the part d.c. is connected to the earth. - SELV is forbidden if part d.c. has a functional ground of one polarity <p>In cases where protection by SELV or PELV is prohibited, the general protection measures apply (double or reinforced insulation).</p>	Shall be considered in the end installation	N/A
7.3	<p>Protection against direct contact</p>		N/A
7.3.1	<p>General case</p> <p>All connection points necessary for the realization of a PV chain whose U_{ocmax} voltage is greater than 60 V, must be provided by connectors including at its ends.</p> <p>These connectors must comply with standard NF EN 50521.</p>		N/A
7.3.2	<p>Case of installation in LV</p> <p>Electrical equipment must be protected by isolation of the live parts or enclosure.</p> <p>Cabinets or boxes containing accessible active parts must be capable of being closed either by means of a key or by means of a tool unless they are situated in a room where only knowledgeable or qualified persons may have access.</p> <p>Where cabinets or cabinets are not located in a room where only knowledgeable or qualified persons may have access, protection against direct contact shall be provided when an access door is opened using equipment which has been constructed or installation, at least the degree of protection IP2X or IPXXB.</p>	Shall be considered in the end installation	N/A

UTE C 15-712-1			
Cl.	Requirement - Test	Result	Verdict
7.3.3	<p>Case of installation in SELV and PELV</p> <p>When the nominal voltage of the SELV circuit is less than or equal to 25 V RMS or 60 V DC smooth, protection against direct contact by insulation of the live parts or enclosure is not necessary.</p> <p>When the nominal voltage of the PELV circuit is less than or equal to 12 V rms AC or 30 V smooth direct current, the protection against direct contact by isolation of the live parts or enclosure is not necessary.</p>	Shall be considered in the end installation	N/A
7.4	<p>Protection against indirect contacts</p>	Shall be considered in the end installation	N/A
7.4.1	<p>General</p> <p>The rules for protection against indirect contact are those set out in part 4-41 of NF C 15-100.</p> <p>The circuits referred to in 411.3.3 of NF C 15-100 and in particular the circuits of living quarters must be protected by a differential device of sensitivity less than or equal to 30 mA.</p> <p>This part attempts to describe the different modes of protection of people against indirect contact in a photovoltaic installation according to the provisions implemented listed d.c. and the presence or absence of a galvanic transformer isolation between the parts d.c. and a.c.</p>	Shall be considered in the end installation	N/A
7.4.2	<p>Continuous current part</p>	Shall be considered in the end installation	N/A
7.4.2.1	<p>General</p> <p>For the direct current part (PV modules, junction boxes, chain cables, group cables, enclosures or grouping cabinets ...), the protection against indirect contacts must be achieved by at least one of the following measures:</p> <ul style="list-style-type: none"> • protection by SELV or PELV; • protection by double or reinforced insulation. However, in the case of installation of cabinets in a room or electrical service area with access reserved for qualified personnel, this cabinet may be class I. 	Shall be considered in the end installation	N/A

UTE C 15-712-1			
Cl.	Requirement - Test	Result	Verdict
7.4.2.2	<p>Protection by double or reinforced insulation The prescriptions of article 412 of NF C 15-100 must be applied.</p> <p>The protection against direct contact is provided by a main insulation and the protection against indirect contacts is provided by additional insulation, or</p> <p>Protection against direct and indirect contacts is ensured by reinforced insulation between live parts and accessible parts.</p>	Shall be considered in the end installation	N/A
7.4.3	<p>Alternating current part Protection against indirect contact is provided by double or reinforced insulation or by automatic power failure, according to one of the following measures:</p> <ul style="list-style-type: none"> • in TT scheme by breaking at the first fault; • in TN diagram by breaking at the first fault; • in IT scheme by breaking the second fault. <p>Table 2 below summarizes the different combinations according to the earth connection diagrams on the a.c. side and on the functional earthing or not on the d.c..</p>	Shall be considered in the end installation	N/A
8	Overcurrent protection	Shall be considered in the end installation	N/A
8.1	Direct current part		N/A
8.1.1	<p>General Figure 7 below summarizes the operations involved in selecting the overcurrent protection devices in part d.c. and size the cables of this part.</p>		N/A
8.1.2	<p>Protection of PV modules In an installation with several PV module chains in parallel, the modules must be protected against the effect of reverse currents that may be generated in the chains in the event of a fault.</p> <p>If the PV generator consists of a single chain, the reverse fault current does not exist, and no overcurrent protection is required.</p> <p>If the PV generator consists of two parallel chains, the maximum reverse current that can circulating in the faulty chain can be worth up to I_{scmax}. The modules of the faulty chain are always able to withstand this reverse current and no protection of the chains overcurrent is not required.</p> <p>If the PV generator consists of N_c parallel strings ($N_c > 2$), the maximum reverse current which can circulate in the faulty chain can be worth up to $(N_c - 1) I_{scmax}$ A device of overcurrent protection is required only if the number of channels.</p>		N/A

UTE C 15-712-1			
Cl.	Requirement - Test	Result	Verdict
8.1.3	<p>Protection of PV chain cables</p> <p>The dimensioning of the PV chain cables takes into account the choice of the PV module protection device adopted in 8.1.2.</p> <p>The dimensioning of the PV chain cables is done using Table 6.</p>		N/A
8.1.4	<p>PV array cable protection</p> <p>In an installation with several PV groups in parallel, the group cables must be protected against the effect of reverse currents due to a short circuit in a group.</p> <p>If the PV generator consists of two groups in parallel, the maximum reverse current flowing in the cable of the faulty group can be up to I_{scmax_GROUP}.</p> <p>If the PV generator consists of N_a groups in parallel ($N_a > 2$), the maximum reverse current flowing in the cable of the faulty group can be up to $(N_a - 1) I_{scmax_GROUP}$.</p> <p>A protection device for PV group cables against overcurrent is only required if their permissible current is less than the maximum reverse group current.</p> <p>The dimensions of the protection devices and the PV group cables are determined using Table 7.</p>		N/A
8.1.5	<p>Protection of main PV cable</p> <p>The main cable of a PV generator must be dimensioned with a current I_z greater than or equal to I_{scmax_GEN}.</p> <p>NOTE Calculation of $I_{scmax_GEN} = N_c I_{scmax}$</p> <p>The choice of the admissible current I_z of the main cable PV must take into account the various correction factors defined in part 5-52 of NF C 15-100.</p>		N/A
8.1.6	<p>Characteristics of overcurrent protection devices</p> <p>The overcurrent protection devices must be either fuses compliant with standard NF EN 60269-1 or circuit-breakers compliant with standard NF EN 60947-2. These devices must be implemented for both polarities, regardless of the configuration of the installation.</p>		N/A
8.2	<p>Alternating current part</p>		N/A
8.2.1	<p>General points</p> <p>In the case of an installation connected to the network via a branch line with limited power, the minimum cross-section of the conductors connected to the terminals downstream of the general isolating and protection device is 10 mm^2 Cu.</p>		N/A

UTE C 15-712-1			
Cl.	Requirement - Test	Result	Verdict
8.2.2	<p>Overload protection</p> <p>Alternating current circuits are protected against surges in accordance with the requirements of article 433 of standard NF C 15-100.</p> <p>For each inverter, the operating current to be taken into account is the maximum current given by the inverter manufacturer or 1.1 times its rated current. The rated current of the switchgear to which the PV system is connected must take into account the operating current of the inverter.</p> <p>The choice of the rating of the protection device must take into account special constraints such as, for example, side-by-side mounting of equipment used simultaneously at their nominal current and / or high ambient temperature.</p>	Shall be considered in the end installation	N/A
8.2.3	<p>Short-circuit protection</p> <p>In the event of a short circuit in an inverter or its pipe, the inverter is considered as the load and the public grid as the source.</p> <p>The breaking capacity of the protective devices of the network-connected installations is determined taking into account the maximum short-circuit currents likely to appear from the network.</p> <p>In the case of a limited power connection, given the upstream protection (presence of fuses AD), a breaking capacity of 3 kA is sufficient for the short circuit protection devices downstream of the delivery point.</p> <p>In the case of an inverter / transformer assembly, for the installation part located between the inverter and its LV / LV or HV / LV transformer located in the vicinity, it is not necessary to provide a protection device against short circuits between the transformer and the inverter when this protection function is provided by the transformer protection.</p>	Shall be considered in the end installation	N/A
8.3	<p>Protection of auxiliary circuits</p> <p>All auxiliary circuits powered by a voltage source (voltage measurement, control, signaling, etc.) must be protected against short circuits.</p>		N/A

UTE C 15-712-1			
Cl.	Requirement - Test	Result	Verdict
9	<p>Decoupling protection</p> <p>This protection is intended for the disconnection of the generators in case of:</p> <ul style="list-style-type: none"> • defect on the public distribution network; • disappearance of power supply by the public distribution network; • variations in voltage or frequency higher than those specified by the distributor. <p>This decoupling protection complies with the provisions of the UTE C 15-400 guide. It is type B.1 for installations with a maximum total power of inverter not exceeding 250 kVA and type H for installations of higher power.</p> <p>In installations with a total power of inverters not exceeding 250 kVA, the decoupling protection can be integrated into the inverters. It must then comply with the pre-standard DIN VDE 0126-1-1 and its amendment 1.</p>	<p>The inverter is less than 250KVA and equipped with the decoupling protection according to DIN VDE 0126-1-1</p>	P
10	<p>Prevention of degradation of photovoltaic installations</p> <p>In order to prevent the degradation of PV installations due to particular external influences and the presence of direct current, and despite the implementation of measures such as the imposition of double insulation and single-conductor cables, additional measures must be taken implemented on the continuous current portion.</p> <p>The measures to be applied are described in Table 8 and depend on:</p> <ul style="list-style-type: none"> • the grounding or not of a polarity d.c. for functional requirements of a PV generator. Grounding can be direct or realized through a resistor; • the presence or absence of a galvanic isolation in the inverter or in the alternating current section. 		N/A
11	<p>Voltage drop</p>	<p>Shall be considered in the end installation</p>	N/A
11.1	<p>General points</p> <p>The objective of technical and commercial optimisations is to minimise voltage drops.</p>	<p>Shall be considered in the end installation</p>	N/A
11.2	<p>Direct current installation</p> <p>The authorised maximum drop in voltage in the direct current part of the installation is between 3% and $I_{mpp}SC C$ (STC: standard test conditions).</p>	<p>Shall be considered in the end installation</p>	N/A

UTE C 15-712-1			
Cl.	Requirement - Test	Result	Verdict
11.3	<p>Alternating current installation</p> <p>For PV installations directly connected to the LV public distribution network, the maximum allowed voltage drop between the ac terminals of the inverter and the delivery point (NF C 14-100) is 3% at rated power of the inverter (s). . It is recommended to limit this voltage drop to 1% so as to limit on the one hand the energy losses, and on the other hand the decoupling momentum of the inverter by preserving a margin between the average operating voltage of the inverter and the setting of its overvoltage protection.</p> <p>For PV installations connected to the public MV distribution network via an MV / LV transformer, the same recommendations apply to the low voltage part.</p>	Shall be considered in the end installation	N/A
12	Sectioning, ordering and cutting		N/A
12.1	<p>Sectioning</p> <p>To enable maintenance of the PV inverters, disconnecting means must be provided by inverter, both on the DC and the AC side.</p> <p>NOTE For high power inverters whose maintainability can be ensured by replacing internal components, the disconnecting device can be integrated into the same enclosure.</p> <p>Sectioning must be omnipolar.</p> <p>The disconnecting devices installed on the DC side may not have simultaneous opening of each polarity.</p>		N/A
12.2	<p>Ordering</p> <p>To allow maintenance interventions, a cut-off device must be provided inside or near the junction boxes equipped with protection devices.</p>		N/A
12.3	Emergency circuit-breakers		N/A
12.3.1	<p>General</p> <p>In application of the rules of 463 and 536.3 of NF C 15-100, emergency cut-off devices on the side a.c. and on the side d.c. must be provided to cut off the power supplies if an unexpected danger occurs.</p> <p>Any emergency cut-off device must be omnipolar and simultaneous.</p> <p>These devices are either switches, circuit breakers or contactors. Semiconductor devices do not meet this requirement.</p> <p>The controls for emergency cut-off devices on the side d.c. and a.c. side must be easily recognizable and quickly accessible. They are located near the inverter.</p> <p>Emergency shutdown devices must not be integrated into the inverter.</p> <p>NOTE For high power inverters, the switchgear can be integrated into the same enclosure.</p>		N/A

UTE C 15-712-1			
Cl.	Requirement - Test	Result	Verdict
12.3.2	<p>Direct current part</p> <p>A cut-off device must be provided upstream of the inverter and its control must be arranged close to the inverter.</p> <p>The actuation of the emergency cut-off device can be ensured by manual control or by remote control action.</p> <p>In the case of multi-input inverters, it is permissible to provide emergency shutdown by separate direct control devices.</p>		N/A
12.3.3	<p>Alternating current part</p> <p>The emergency shutdown can be ensured by a manual control of the cut-off device or by means of a remote control action.</p>		N/A
12.3.4	<p>Special provisions for living quarters</p> <p>In private residential premises (paragraph 771.463 of NF C 15-100), for direct current and alternating current, only direct acting devices are authorized.</p> <p>If the path between the inverter and the network passes through the residential part, the emergency shutdown device of the PV installation must be installed, in accordance with paragraphs 771.463 and 771.558 of NF C 15-100, in the residential part in the Housing Technical Sheath if it exists.</p>		N/A
12.4	<p>Emergency services intervention cut-off</p>		N/A

UTE C 15-712-1			
Cl.	Requirement - Test	Result	Verdict
12.4.1	<p>General points</p> <p>If a cut-off is required to allow the intervention of the emergency services, it must meet the following principles:</p> <ul style="list-style-type: none"> - cutting off all sources of electrical energy: <ul style="list-style-type: none"> • PV generator; • public distribution network - the cut-off devices must comply with the following principles; <ul style="list-style-type: none"> • these devices are either switches, circuit breakers or contactors; <p>semiconductor devices do not meet this requirement;</p> <ul style="list-style-type: none"> • each device must be omnipolar and simultaneous; <p>the interruption of the PV generator circuit is carried out as close as possible to the photovoltaic modules, and in any event upstream of the premises and clearances accessible to the occupants;</p> <ul style="list-style-type: none"> - the controls of these cut-off devices for intervention of the emergency services are GROUPd together. In the case of installations on an existing building, it is permissible to have UnGROUPd orders. <p>The cut-off devices can be:</p> <ul style="list-style-type: none"> - with direct mechanical action; - remote controlled (electric or pneumatic). <p>The remote control can be provided according to one of the three principles:</p> <ul style="list-style-type: none"> • undervoltage release; • current release device or powered actuator, via cables of type CR1, by an AES (Electrical Safety Power Supply) implemented according to the paragraph 562.8 of NF C 15-100; • Pneumatic actuation with a compressed gas energy source and copper or steel pipes (according to the NF EN 12101 series of standards). <p>The signaling of the effective action of cutoff must be carried out by indications of measures voltage or O / F type free-loop devices. In the case of use of the measurement of voltage d.c., it should then be taken between the cut-off device and the to secure. The cables used for signaling are CR1 type.</p> <p>This signaling is ensured by the extinction of a white light which indicates the effective cut.</p>		N/A

UTE C 15-712-1			
Cl.	Requirement - Test	Result	Verdict
12.4.2	<p>Additional provisions</p> <p>If it is required to lower to a value below 60 V d.c. the voltage of the PV generator circuit in upstream of the cut required in the general provisions of 12.4.1, this is achieved by:</p> <ul style="list-style-type: none"> • an electromechanical break in load or off load in series in each chain PV per section whose voltage U_{ocmax} is less than or equal to 60 V, or • electromechanical or electronic short-circuiting systems for which the U_{ocmax} voltage is less than or equal to 60 V, or • electromechanical or electronic short-circuiting systems per module <p>The operational safety of these principles requires:</p> <ul style="list-style-type: none"> • a positive security command; • in the case of an electromechanical outage, the order must be performed after opening the downstream charging device. Implementation of these materials must comply with the rules of double insulation (or reinforced insulation) imposed in this part of the installation and this for a voltage corresponding to the U_{ocmax} voltage of the chain. 		N/A
13	Protection against overvoltages of atmospheric origin or due to maneuvers		N/A
13.1	<p>General</p> <p>The information in this chapter deals with surge protection for photovoltaic installations connected to the grid in addition to the standard NF C 15-100 and UTE guide C 61-740-52.</p> <p>NOTE In view of the sensitivity and location of photovoltaic modules, particular attention should be given to also be brought to protection against the direct effects of lightning, in particular for important. This subject is treated by standards NF EN 62305-1 to -3 (C 17-100-1 to -3) and standard NF C 17-102</p>		N/A
13.1.1	Principles of protection		N/A
13.1.1.1	<p>Equipotentiality protection</p> <p>As described in section 6.3, a protective equipotentiality conductor must connect all metal structures of the modules and the metal structures of the PV installation supports (including including metal cable trays) in the presence or absence of surge arresters. This driver must be connected to the ground.</p>		N/A
13.1.1.2	<p>Protection by surge arresters</p> <p>The installation conditions of the surge arresters are described in 13.2</p>		N/A
13.2	Installation conditions for surge arresters	Shall be considered in the end installation	N/A

UTE C 15-712-1			
Cl.	Requirement - Test	Result	Verdict
13.2.1	<p>Arrester installation condition a.c</p> <p>The provisions of Articles 443 and 534 of NF C 15-100 apply. The map showing the densities of lightning (Ng) in France is attached in Appendix C.</p>	Shall be considered in the end installation	N/A
13.2.2	<p>Surge arrester installation condition d.c.</p>	Shall be considered in the end installation	N/A
13.2.2.1	<p>Installation without lightning rod</p> <p>The length L is the cumulative distance between the inverter (s) and the input points of the further apart, considering each path (see Figure 8).</p>		N/A
13.2.2	<p>Installation with lightning rod</p> <p>The implementation of arrester (s) is mandatory on the generator side d.c. :</p> <ul style="list-style-type: none"> ● metal structure of the PV modules connected to the lightning rod: Type 1; ● PV production plant on the ground with lightning rod: Type 1; ● metallic structure of the PV modules not connected to the lightning conductor: Type 2. <p>In the case of implementation of Type 1 surge arresters, one is implemented on the modules side, the other is implemented on the inverter side. In the presence of lightning conductors, the choice and the implementation of surge arresters are made in accordance with the UTE guide C 61-740-52..</p>		N/A
13.3	<p>Surge protection of installations without lightning rod</p>		N/A
13.3.1	<p>Choice and implementation of surge arresters on the a.c.</p> <p>When a surge arrester is prescribed for the part a.c. of a PV installation connected to the network public low-voltage distribution, it is always installed in the table located closest to the origin of the installation in the installation. According to the UTE guide C 61-740-52, the voltage seen by the equipment depends on their distance relating to the surge arrester. Beyond 10 m, the value of this voltage can be doubled under the effect of resonances (amplification phenomena due to the high frequencies of the original overvoltages lightning). In this case, a second surge arrester is required as close as possible to the inverter if the level Up protection of the surge arrester located near the origin of the installation is greater than 50% the shock resistance of the inverter. The selection and implementation are carried out in accordance with the rules set out in Articles 443 and 534 of NF C 15-100. For installations connected to the MV network, a specific study is to be validated with the distributor.</p>		N/A

UTE C 15-712-1			
Cl.	Requirement - Test	Result	Verdict
13.3.2	<p>Choice and implementation of surge arresters on the d.c.</p> <p>When a surge arrester is prescribed for part d.c. of a PV installation, it is always installed in the table closest to the inverter.</p> <p>According to the UTE guide C 61-740-52, the voltage seen by the equipment depends on their distance relating to the surge arrester. Beyond 10 m (see Figures 11 and 12), the value of this voltage can be doubled under the effect of resonances (amplification phenomena due to the high frequencies of overvoltages of origin lightning). In this case, a second surge arrester is needed close to the modules if the protection level U_p of the surge arrester located near the inverter is higher at 50% of the withstand voltage of the photovoltaic field U_w (see Table 10).</p>		N/A
13.3.2.1	<p>Choice of I_n</p> <p>I_n rated discharge current of a surge arrester in 8/20 μs waveform (in kA)</p> <p>Type 2 surge arresters have a minimum value of the nominal discharge current I_n of 5 kA.</p> <p>A rated discharge current greater than the required value will provide a longer service life.</p> <p>long to arrester.</p>		N/A
13.3.2.2	<p>Choice of I_{max}</p> <p>I_{max}: maximum discharge current of a surge arrester with wave 8/20 μs (in kA)</p> <p>This parameter is used for energy coordination of surge arresters: refer to manufacturer's information.</p> <p>NOTE This coordination can be done, by analogy with the a.c. networks, according to the rules of the guide UTE C 61-740-52.</p>		N/A
13.3.2.3	<p>Choice of I_{imp}</p> <p>The shock current I_{imp} of the type 1 surge arresters is chosen according to the UTE guide C 1-740-52 or by default with a minimum value of 12.5 kA.</p>		N/A
13.3.2.4	<p>Choosing U_p</p> <p>The value of U_p must be less than 80% of the value of the rated impact voltage materials to protect.</p> <p>The rated U_w impulse voltage for modules and conversion equipment is given in Table 10.</p>		N/A

UTE C 15-712-1			
Cl.	Requirement - Test	Result	Verdict
13.3.2.5	<p>Choice of UCPV</p> <p>U_{CPV} maximum steady state voltage of a photovoltaic arrester dedicated to the protection of part d.c. of the PV generator</p> <p>The value of the maximum permissible voltage for the UCPV surge arrester must be selected function of the maximum empty voltage of the PV generator corresponding to the given voltage U_{ocSTC} by PV module manufacturers. The UCPV voltage must be greater than or equal to the voltage U_{ocmax} maximum of the photovoltaic generator.</p> <p>Whatever the modes of protection of the surge arrester, it must also be able to withstand the maximum voltage U_{ocmax} between its active terminals (+ and - terminals) and the earth.</p>		N/A
13.3.2.6	<p>Choice of ISCPV and protection device associated with surge arrester</p>		N/A
13.4	<p>Supplementary rules for overvoltage protection of installations with lightning rod</p> <p>The rules are defined in the UTE guide C 61-740-52.</p>		N/A
14	<p>Choice and implementation of materials</p>		N/A
14.1	<p>General</p>		N/A
14.2	<p>Pipelines</p>		N/A
14.3	<p>PV modules</p> <p>The PV modules must comply with the standards in series NF EN 61730.</p>		N/A
14.4	<p>Inverters</p> <p>The injection inverters must comply with the standards IEC 62109-1 and NF EN 62109-2. Current sizing of the injection inverter must be based on I_{mppSTC}.</p> <p>The direct current generated by the injection inverter (s) on the public distribution network must be less than 0.5% of its rated current.</p>		P

UTE C 15-712-1			
Cl.	Requirement - Test	Result	Verdict
14.5	<p>Equipment</p> <p>All equipment installed in the d.c. part must be adapted for operation in direct current and be selected and installed in accordance with the manufacturer's instructions.</p> <p>Equipment installed in the d.c. part must be of the industrial type, in other words compliant with the NF EN 60947 series of standards.</p> <ul style="list-style-type: none"> ● The characteristics of switches, switch-disconnectors and fuse-combination units must conform to the operating category DC21 B. ● The characteristics of disconnectors must conform to the operating category DC20. ● The characteristics of contactors must conform to the operating category DC1. 		N/A
14.6	<p>Equipment assemblies</p> <p>The direct current and alternating parts of the installation can be accommodated in the same panel if there is a physical separation of these two parts.</p> <p>For the d.c. part, it is imperative to protect all the connections or disconnection devices against accidental or unauthorised opening when live in accordance with 536.2.3 of standard NF C 15-100. To this end, a notice "Do not operate when live" must be placed inside the boxes or cabinets near these disconnection devices.</p> <p>Furthermore, in premises accessible to persons other than those with the requisite authorisation or qualification (BA4 or BA5):</p> <ul style="list-style-type: none"> ● The design or installation must be such that it is only possible to disassemble the connection devices with the aid of a tool; ● Equipment that does not have an under load circuit-breaking feature must require the either the use of a key or tool or the direct operation of a device with an under load circuit-breaking feature. 		N/A
14.7	<p>Connectors</p> <p>In the d.c. part, the connectors used must comply with the standard NF EN 50521. To guarantee the quality of the connection and limit the risks of an electric arc that could spark a fire, each pair of male and female connectors to be assembled, must be of the same type and the same brand.</p>		N/A
14.8	<p>Surge arresters</p>		N/A

UTE C 15-712-1			
Cl.	Requirement - Test	Result	Verdict
14.8.1	<p>Choice of Surge arresters</p> <p>The lightning arresters installed in the a.c. part of the PV installation must comply with standard NF EN 61643-11.</p> <p>The surge arresters installed on the part d.c. of the PV installation must meet the requirements of the standard NF EN 50539-11.</p>		N/A
14.8.2	<p>Installation of Surge arresters</p> <p>Alternating current and direct current lightning arresters are installed in accordance with the regulations set out in guide UTE C 61-740-52.</p>		N/A
15	Markings		P
15.1	<p>Identification of components</p> <p>The main components comprising the photovoltaic installations must be identified and marked with clearly visible labels fixed permanently in accordance with the installation plans and diagrams:</p>		P
15.2	<p>Labelling</p> <p>For safety reasons and to alert the different people carrying out work in and around the building (staff tasked with maintenance work, inspectors, public distribution network operators, emergency services, etc.), it is imperative that the presence of a photovoltaic installation on a building is indicated.</p>	Shall be considered in the end installation	N/A
15.2.1	Labelling on the a.c.part	Shall be considered in the end installation	N/A
15.2.2	<p>Labelling on the d.c. part</p> <p>All the junction boxes (PV generator and PV groups) and d.c. ducts must carry a visible and permanent marking indicating that live parts within these boxes may remain under voltage even after the inverter has been disconnected on the direct current side.</p>	Shall be considered in the end installation	N/A
15.2.3	<p>Labelling on the inverter</p> <p>All inverters must bear a marking indicating that before any work is carried out, the two sources of voltage must be isolated.</p>	Shall be considered in the end installation	N/A

UTE C 15-712-1			
Cl.	Requirement - Test	Result	Verdict
15.3	<p>Specific Labels for Emergency Response</p> <p>If specific labeling for the intervention of the rescue services is required, it responds to principles described below.</p> <p>The purpose of this signage is to provide emergency services with information that enable a decision-making approach to quickly know:</p> <ul style="list-style-type: none"> • if and how secure is the area accessible to people to be rescued; • if there are cut-off devices according to paragraph 12.5 and if the cut is effective. <p>This signage affixed next to the general control and sectioning device (or AGCP) will complete the signage dedicated to the general control devices and severing of consumption and production facilities as defined in paragraph 12</p>		N/A
16	<p>Technical file</p> <p>The technical file must include the following items drawn up in French:</p> <ul style="list-style-type: none"> • A circuit diagram of the photovoltaic system; • The list of installed equipment mentioning the characteristics and references to the replacement parts (fuses, lightning arrester cartridges etc.); • An installation diagram for the various photovoltaic components and modules as well as the corresponding connections (ducts); • A description of the procedure for working on the photovoltaic system and safety instructions. 	Shall be considered in the end installation	N/A
17	<p>Maintenance of photovoltaic installations</p>	Shall be considered in the end installation	N/A
17.1	<p>General</p> <p>The minimal technical maintenance work must be provided for during the life cycle of a photovoltaic installation to maintain or restore the installation to a state in which it can fulfil the function for which it was designed.</p>	Shall be considered in the end installation	N/A

UTE C 15-712-1			
Cl.	Requirement - Test	Result	Verdict
17.2	<p>Types of maintenance and periodicity A</p> <p>The following three types of maintenance will be distinguished corresponding to the operations of:</p> <ul style="list-style-type: none"> ● conditional maintenance, based on monitoring of significant parameters the installation; ● predictive maintenance, performed according to the extrapolated forecasts of the analysis and evaluation of the significant parameters of the degradation of the property (eg corrosion); ● Systematic maintenance, carried out at pre-established time intervals and without prior checking of the condition of the property or its component parts; the recommended periodicity is one year. <p>For all types of installation, apart from individual living quarters not intended for temporary or seasonal occupancy, the three levels of maintenance should be considered.</p>	Shall be considered in the end installation	N/A
17.3	<p>Technical areas covered during maintenance</p> <p>A distinction is made between operations relating to the safety of persons and property, and actions relating to functional reliability.</p>		N/A
Annex A	<p>Agreements between the administrator of the public distribution network and the user/produce</p>		N/A
A1	<p>Provisions for limiting effects adversely affecting supply quality</p> <p>The study of the connection by the administrator of the public distribution network requires the communication of the characteristic data for the project, the generators and the provisions for connection to the network. The administrator of the public distribution network may disclose data sheets summarising the minimum list of data required to study the request.</p>		N/A
A2	<p>Choice of tripping device and approval</p> <p>The installation or modification of a tripping device must be subject to an agreement with the administrator of the public distribution network. This process must take account of the situation and the features at the point of delivery and must therefore, where necessary, be coordinated with the connection study for the site.</p>		N/A

UTE C 15-712-1			
Cl.	Requirement - Test	Result	Verdict
A3	<p>Start-up by the administrator of the public distribution network</p> <p>For installations with a power of less than 250 WA, this step is subject to prior submission of proof of conformity stamped by CONSUEL (Comite National pour la Securite des Usagers de l'Electricite, the National Committee for the Safety of Users of Electricity).</p>		N/A
Annex B	<p>Cables for photovoltaic installations - values for permissible currents (informative)</p>		-
	<p>Specific cables for photovoltaic installations have been refined in order to meet the needs of these installations. The tables below, taken from document UTE C 32-502, give the values for the permissible currents for cables compliant with this guide.</p>		N/A
Annex C	<p>Keraunic levels in France and in the overseas departments (informative)</p>		-

Appendix A: Photos



Front view

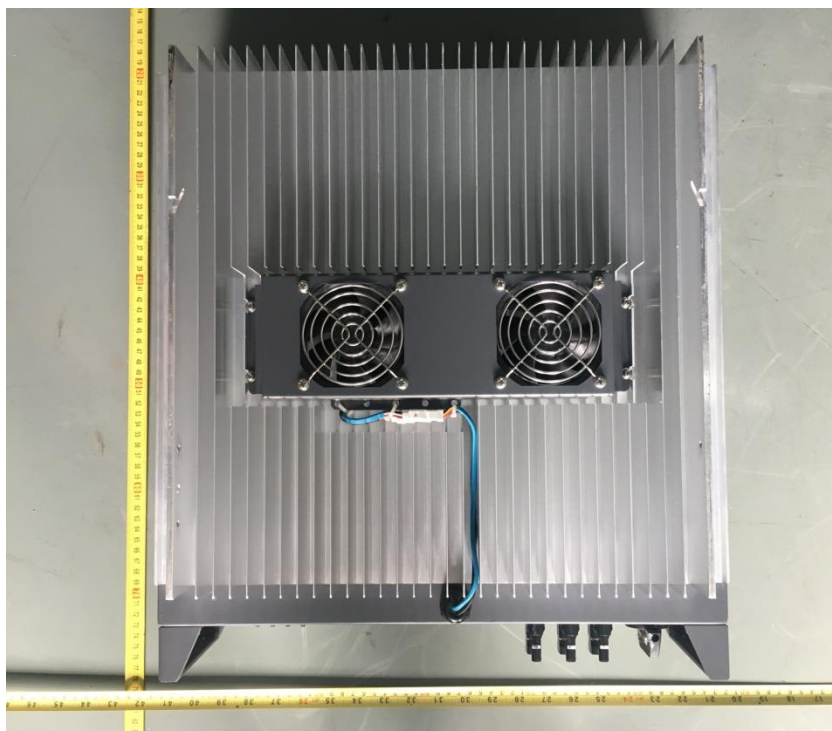

Rear view

Appendix A: Photos



Connection view



Internal view

Appendix A: Photos



Internal view (for model SOFAR 10000TL-G2, SOFAR 12000TL-G2)



Internal view (for model SOFAR 15000TL-G2)