





**BUREAU
VERITAS**

Test Report No: LD200511N080



Test Report No.:	LD200511N080
Client	
Name :	Shenzhen SOFARSOLAR Co., Ltd.
Address :	401, Building 4, AnTongDa Industrial Park, District 68, XingDong Community, XinAn Street, BaoAn District, Shenzhen, China
Test Item :	Solar Grid-tied Inverter
Identification :	SOFAR 15KTLX-G3, SOFAR 17KTLX-G3, SOFAR 20KTLX-G3, SOFAR 22KTLX-G3, SOFAR 24KTLX-G3
Issued by	
Name :	Bureau Veritas Shenzhen Co., Ltd. Dongguan Branch
Address :	No. 96, Guantai Road (Houjie Section), Houjie Town, Dongguan City, Guangdong Province, 523942, People's Republic of China
Test specification	
Standard :	IEC/EN 62109-1:2010, IEC/EN 62109-2:2011
Test Result :	The sample satisfies to the clauses examined.
Prepared By :	
	

	Lukes Lin Engineer / Safety Department
	2020-12-17 Date
Approved By:	
	

	James Huang Technical Manager / Safety Department
	2020-12-17 Date
<small>This report is governed by, and incorporates by reference, CPS Conditions of Service as posted at the date of issuance of this report at http://www.bureauveritas.com/home/about-us/our-business/cps/about-us/terms-conditions and is intended for your exclusive use. Any copying or replication of this report to or for any other person or entity, or use of our name or trademark, is permitted only with our prior written permission. This report sets forth our findings solely with respect to the test samples identified herein. The results set forth in this report are not indicative or representative of the quality or characteristics of the lot from which a test sample was taken or any similar or identical product unless specifically and expressly noted. Our report includes all of the tests requested by you and the results thereof based upon the information that you provided to us. Measurement uncertainty is only provided upon request for accredited tests. You have 60 days from date of issuance of this report to notify us of any material error or omission caused by our negligence or if you require measurement uncertainty; provided, however, that such notice shall be in writing and shall specifically address the issue you wish to raise. A fail</small>	



TEST REPORT	
IEC/EN 62109-1:2010, IEC/EN 62109-2:2011	
Safety of power converters for use in photovoltaic power systems – Part 1: General requirements Part 2: Particular requirements for inverters	
Report Number..... :	LD200511N080
Date of issue..... :	2020-12-17
Total number of pages	109
Testing laboratory	
Test location..... :	Bureau Veritas Shenzhen Co., Ltd. Dongguan Branch
Address..... :	No. 96, Guantai Road (Houjie Section), Houjie Town, Dongguan City, Guangdong Province, 523942, People's Republic of China
Applicant's name	Shenzhen SOFARSOLAR Co., Ltd.
Address..... :	401, Building 4, AnTongDa Industrial Park, District 68, XingDong Community, XinAn Street, BaoAn District, Shenzhen, China
Test specification:	
Standard	IEC/EN 62109-1:2010 IEC/EN 62109-2:2011
Non-standard test method.....:	N/A
Test Report Form No. :	TEST REPORT IEC 62109-2 VER.5
Test Report Form(s) Originator :	Bureau Veritas Shenzhen Co., Ltd. Dongguan Branch
Master TRF	Dated 2016-08
Test item description..... :	Solar Grid-tied Inverter
Trade Mark..... :	
Manufacturer	Shenzhen SOFARSOLAR Co., Ltd.
Model/Type reference..... :	SOFAR 15KTLX-G3, SOFAR 17KTLX-G3, SOFAR 20KTLX-G3, SOFAR 22KTLX-G3, SOFAR 24KTLX-G3



Ratings.....	SOFAR 15KTLX-G3	SOFAR 17KTLX-G3	SOFAR 20KTLX-G3
Input DC voltage [V].....	Max. 1100Vd.c.		
MPPT DC voltage range [V]	140-1000Vd.c.		
Full load MPPT DC voltage range [V].....	420-850 Vd.c.	450-850 Vd.c.	480-850 Vd.c.
Input DC current [A]	Max. 26.0A /26.0A		
Output AC voltage [V]	3/N/P, 380/400Va.c., 50/60Hz		
Output AC current [A]	3 x 23.9	3 x 27.1	3 x 31.9
Nominal Output power [kW].....	15.0	17.0	20.0
Maximum Output power [kVA].....	16.5	18.7	22.0
Ratings.....			
	SOFAR 22KTLX-G3	SOFAR 24KTLX-G3	
Input DC voltage range [V]	Max. 1100Vd.c.		
MPPT DC voltage range [V]	140-1000Vd.c.		
Full load MPPT DC voltage range [V].....	510-850 Vd.c.	540-850 Vd.c.	
Input DC current [A]	Max. 26.0A /26.0A		
Output AC voltage [V]	3/N/P, 380/400Va.c., 50/60Hz		
Output AC current [A]	3 x 35.1	3 x 38.3	
Nominal Output power [kW].....	22.0	24.0	
Maximum Output power [kVA].....	24.2	26.4	



Copy of marking plate (representative)

SOFAR SOLAR Solar Grid-tied Inverter

Model No:	SOFAR 15KTLX-G3
Max. DC Input Voltage	1100V
Operating MPPT Voltage Range	140~1000V
Max. Input Current	26A/26A
Max. PV Isc	36A/36A
Nominal Grid Voltage	3/N/PE, 380/400V
Max. Output Current	3x23.9A
Nominal Grid Frequency	50/60Hz
Nominal Output Power	15000W
Max. Output Power	16500VA
Power Factor	1 (adjustable+/-0.8)
Ingress Protection	IP65
Operating Temperature Range	-30°C~+60°C
Protective Class	Class I
Made in China	

Manufacturer : Shenzhen SOFARSOLAR Co., Ltd.
Address : 401, Building 4, AnTongDa Industrial Park,
District 68, XingDong Community, XinAn Street,
BaoAn District, Shenzhen, China
VDE0126-1-1, VDE-AR-N4105, G99, IEC61727
IEC62116, UTE C 15-712-1, AS4777

SOFAR SOLAR Solar Grid-tied Inverter

Model No:	SOFAR 17KTLX-G3
Max. DC Input Voltage	1100V
Operating MPPT Voltage Range	140~1000V
Max. Input Current	26A/26A
Max. PV Isc	36A/36A
Nominal Grid Voltage	3/N/PE, 380/400V
Max. Output Current	3x27.1A
Nominal Grid Frequency	50/60Hz
Nominal Output Power	17000W
Max. Output Power	18700VA
Power Factor	1 (adjustable+/-0.8)
Ingress Protection	IP65
Operating Temperature Range	-30°C~+60°C
Protective Class	Class I
Made in China	

Manufacturer : Shenzhen SOFARSOLAR Co., Ltd.
Address : 401, Building 4, AnTongDa Industrial Park,
District 68, XingDong Community, XinAn Street,
BaoAn District, Shenzhen, China
VDE0126-1-1, VDE-AR-N4105, G99, IEC61727
IEC62116, UTE C 15-712-1, AS4777

SOFAR SOLAR Solar Grid-tied Inverter

Model No:	SOFAR 20KTLX-G3
Max. DC Input Voltage	1100V
Operating MPPT Voltage Range	140~1000V
Max. Input Current	26A/26A
Max. PV Isc	36A/36A
Nominal Grid Voltage	3/N/PE, 380/400V
Max. Output Current	3x31.9A
Nominal Grid Frequency	50/60Hz
Nominal Output Power	20000W
Max. Output Power	22000VA
Power Factor	1 (adjustable+/-0.8)
Ingress Protection	IP65
Operating Temperature Range	-30°C~+60°C
Protective Class	Class I
Made in China	

Manufacturer : Shenzhen SOFARSOLAR Co., Ltd.
Address : 401, Building 4, AnTongDa Industrial Park,
District 68, XingDong Community, XinAn Street,
BaoAn District, Shenzhen, China
VDE0126-1-1, VDE-AR-N4105, G99, IEC61727
IEC62116, UTE C 15-712-1, AS4777

SOFAR SOLAR Solar Grid-tied Inverter

Model No:	SOFAR 22KTLX-G3
Max. DC Input Voltage	1100V
Operating MPPT Voltage Range	140~1000V
Max. Input Current	26A/26A
Max. PV Isc	36A/36A
Nominal Grid Voltage	3/N/PE, 380/400V
Max. Output Current	3x35.1A
Nominal Grid Frequency	50/60Hz
Nominal Output Power	22000W
Max. Output Power	24200VA
Power Factor	1 (adjustable+/-0.8)
Ingress Protection	IP65
Operating Temperature Range	-30°C~+60°C
Protective Class	Class I
Made in China	

Manufacturer : Shenzhen SOFARSOLAR Co., Ltd.
Address : 401, Building 4, AnTongDa Industrial Park,
District 68, XingDong Community, XinAn Street,
BaoAn District, Shenzhen, China
VDE0126-1-1, VDE-AR-N4105, G99, IEC61727
IEC62116, UTE C 15-712-1, AS4777



Copy of marking plate (representative)

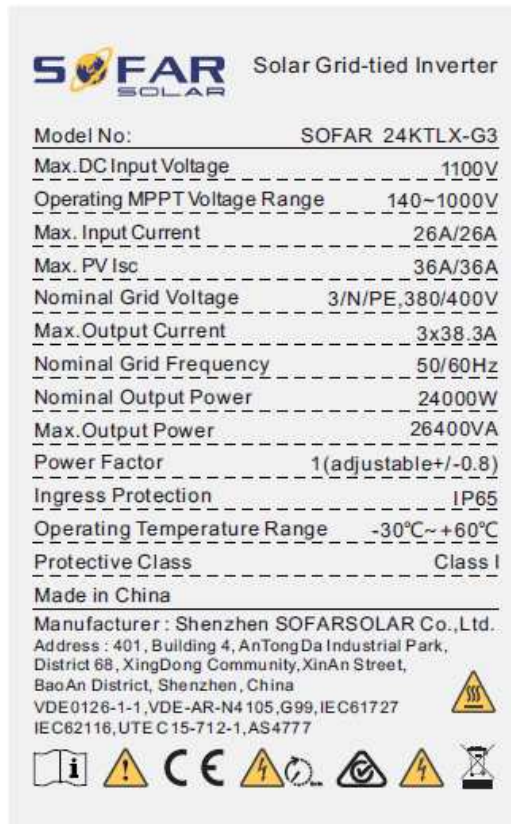



Test item particulars:	
Equipment mobility.....:	<input type="checkbox"/> movable <input type="checkbox"/> hand-held <input type="checkbox"/> stationary <input checked="" type="checkbox"/> fixed <input type="checkbox"/> transportable <input type="checkbox"/> for building-in
Connection to the mains.....:	<input type="checkbox"/> pluggable equipment <input type="checkbox"/> direct plug-in <input checked="" type="checkbox"/> permanent connection <input type="checkbox"/> for building-in
Enviromental category.....:	<input checked="" type="checkbox"/> outdoor <input type="checkbox"/> indoor unconditional <input type="checkbox"/> indoor conditional
Over voltage category Mains.....:	<input type="checkbox"/> OVC I <input type="checkbox"/> OVC II <input checked="" type="checkbox"/> OVC III <input type="checkbox"/> OVC IV
Over voltage category DC.....:	<input type="checkbox"/> OVC I <input checked="" type="checkbox"/> OVC II <input type="checkbox"/> OVC III <input type="checkbox"/> OVC IV
Mains supply tolerance (%).....:	-90 / +110 %
Tested for power systems.....:	TN / TT / IT
IT testing, phase-phase voltage (V).....:	380/400V
Class of equipment.....:	<input checked="" type="checkbox"/> Class I <input type="checkbox"/> Class II <input type="checkbox"/> Class III <input type="checkbox"/> Not classified
Mass of equipment (kg).....:	Approx. 20,0 kg for SOFAR 15KTLX-G3; Approx. 22,0 kg for SOFAR 17KTLX-G3, SOFAR 20KTLX-G3; Approx. 23,0 kg for SOFAR 22KTLX-G3, SOFAR 24KTLX-G3;
Pollution degree.....:	PD3
IP protection class.....:	IP65
Testing	
Date of receipt of test item(s).....:	2020-05-11
Dates tests performed.....:	2020-05-11 to 2020-12-17
Possible test case verdicts:	
- test case does not apply to the test object	N/A
- test object does meet the requirement	Pass (P)
- test object was not evaluated for the requirement.....	N/E
- test object does not meet the requirement	Fail (F)



General remarks:

The test results presented in this report relate only to the object tested.

This report shall not be reproduced, except in full, without the written approval of the Issuing testing laboratory.

"(See Enclosure #)" refers to additional information appended to the report.

"(See appended table)" refers to a table appended to the report.

Throughout this report a comma / point is used as the decimal separator.

Name and address of factory (ies): Dongguan SOFAR SOLAR Co.,Ltd.

1F - 6F, Building E, No. 1 JinQi Road, Bihu Industrial Park,
Wulian Village, Fenggang Town, Dongguan City, Guangdong,
China.

General product information:

The Solar converter converts DC voltage into AC voltage.
 The DC input of Solar converter can be supplied from PV array.
 The Solar converter is a three-phase type with TN, TT and IT system.
 The unit is providing EMC filtering at the output toward mains. The unit does not provide galvanic separation from input to output (transformerless). The output is switched off redundant by the high power switching bridge and a two relays. This assures that the opening of the output circuit will also operate in case of one error.

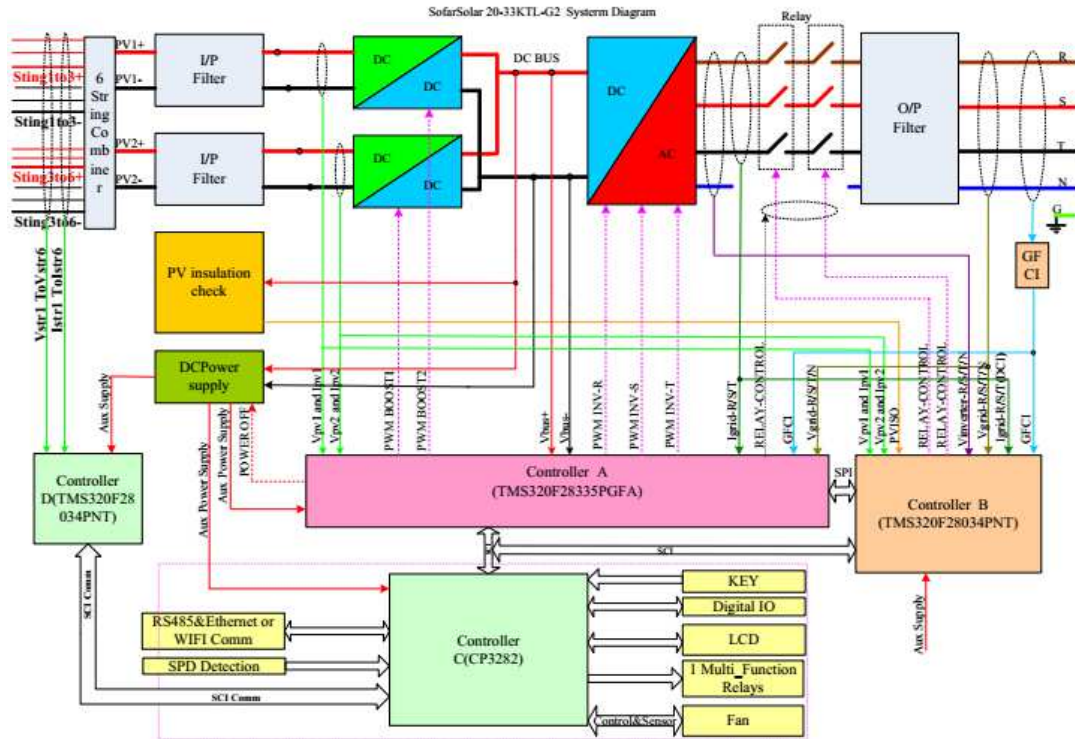

Figure 1-Block diagram

The internal control is redundant built. It consists of Microcontroller A (U30) and Microcontroller B (U23). The Microcontroller A (U30) control the relays by switching signals; measures the PV voltage, PV current, Bus voltage, grid voltage, frequency, AC current with injected DC and the array insulation resistance to ground. In addition it tests the current sensors and the RCMU circuit before each start up. The Microcontroller B (U23) is measures the grid voltage, grid frequency, DCI and residual current, also can switch off the relays independently, and communicate with the Microcontroller A (U30) each other. The current is measured by a current sensor. The AC current signal and the injected DC current signal are sent to the Microcontroller A (U30). The Microcontroller A (U30) tests and calibrates before each start up all current sensors. The unit provides two relays in series in all output conductors. When single fault applied to one relay, alarm an error code in display panel, another redundant relay provides basic insulation maintained between the PV array and the mains. All the relays are tested before each start up.

The product was tested on:

Hardware version: V101
 Software version: V010000



Differences of the models

The model SOFAR 15KTLX-G3, SOFAR 17KTLX-G3, SOFAR 20KTLX-G3, SOFAR 22KTLX-G3 and SOFAR 24KTLX-G3 are almost identical in hardware, except the Communication control (CSB or COM), DC input channel and Fuse board for PV input. The difference as below.

	SOFAR 15KTLX-G3	SOFAR 17KTLX-G3	SOFAR 20KTLX-G3 SOFAR 22KTLX-G3 SOFAR 24KTLX-G3
BUS film capacitor	4 pcs 110uF/550V	6 pcs 110uF/550V	
Inverter IGBT	6 pcs 40A/1200V	6 pcs 75A/1200V	
fan	1 pcs		2 pcs

Test condition:

Temperature: 20±5°C
Relative humidity: 60%
Air pressure: 950 mbar

The test samples were pre-production samples without serial number.



This testreport includes the following Appendixes:

Appendix No.	Description	Page(s)
1	4.8.2 TABLE: Array insulation resistance detection for inverters for ungrounded and functionally grounded arrays (page 100).	1
2	4.8.3.5 Protection by residual current monitoring (page 101-102).	2



IEC/EN 62109-1, IEC/EN 62109-2			
Clause	Requirement – Test	Result – Remark	Verdict
4	GENERAL TESTING REQUIREMENTS		P
4.1	General		P
4.2	General conditions for testing	See appended table.	P
4.3	Thermal testing	See appended table.	P
4.3.1	General		P
4.3.2	Maximum temperatures	See appended table.	P
4.3.2.1	General		P
4.3.2.2	Touch temperatures		P
	In order to limit the touch temperatures of accessible parts of PCE, the maximum temperature for accessible parts of the PCE shall be in compliance with Table 3.	Considered.	P
	It is permitted that accessible parts that are required to get hot as part of their intended function (for example heatsinks) may have temperatures up to 100 °C, if the parts are marked with the hot surface marking of symbol 14 of Annex C. For products only for use in a closed electrical operating area the 100 °C limit does not apply.	Considered.	P
	These limits are in addition to the applicable limits in 4.3.2.1.	Considered.	P
4.3.2.3	Temperature limits for mounting surfaces		P
	In order to protect against long-term degradation of building materials, surfaces of the PCE that will be in contact with the mounting surface shall not exceed a maximum total temperature of 90 °C. This limit is in addition to the applicable limits in 4.3.2.1 and 4.3.2.2. Compliance is checked by the testing in 4.3.2.1 with the PCE mounted according to the manufacturer's instructions, on a softwood surface.	Considered.	P
4.4	Testing in single fault condition	See appended table.	P
4.4.1	General		P
4.4.2	Test conditions and duration for testing under fault conditions	Considered.	P
4.4.2.1	General		P
4.4.2.2	Duration of tests	Considered.	P
4.4.3	Pass/fail criteria for testing under fault conditions		P
4.4.3.1	Protection against shock hazard	No shock hazard.	P
4.4.3.2	Protection against the spread of fire	No spread of fire.	P
4.4.3.3	Protection against other hazards	No other hazards.	P
4.4.3.4	Protection against parts expulsion hazards	No expulsion hazard.	P
4.4.4	Single fault conditions to be applied	Considered.	P
4.4.4.1	Component fault tests	See appended table.	P
4.4.4.2	Equipment or parts for short-term or intermittent operation	Continue-operation.	N/A
	Components such as motors, relays, other electromagnetic devices and heaters, which are normally operated only intermittently, shall be operated continuously if continuous operation could occur in a single fault condition.		N/A
4.4.4.3	Motors		P
4.4.4.4	Transformer short circuit tests	See appended table.	P
4.4.4.5	Output short circuit	See appended table.	P



IEC/EN 62109-1, IEC/EN 62109-2			
Clause	Requirement – Test	Result – Remark	Verdict
4.4.4.6	Backfeed current test for equipment with more than one source of supply	Considered.	P
	For equipment intended to be connected simultaneously to more than one source of supply, each input of the PCE shall be tested one at a time, to determine if hazardous conditions can result from current from one source of supply flowing into the wiring for another source under fault conditions.	Considered.	P
	With the PCE operating under normal conditions, a short circuit shall be applied at the field wiring terminals of the circuit under consideration, with all intended other sources connected to the PCE through the overcurrent protective devices (if any) intended to be present in the installation.	Considered.	P
	In addition to the requirements of 4.4.3, the short-circuit currents are to be recorded and if they exceed the maximum rated current for the port, the maximum measured current shall be provided in the installation manual for the purpose of coordination of overcurrent protection of the external circuit conductors (see 5.3.2).		N/A
4.4.4.7	Output overload	Considered.	P
4.4.4.8	Cooling system failure		P
	Equipment cooling shall be faulted as follows, one fault at a time:	See below.	P
	a) air-intakes shall be blocked or partially blocked;	Considered.	P
	b) cooling fans shall be stopped or disconnected, one at a time;	Considered.	P
	c) cooling by circulation of water or other coolant shall be stopped or partially restricted.	No such coolant circulation devices.	N/A
4.4.4.9	Heating devices	No heating devices.	N/A
	In equipment incorporating heating devices, the following faults shall be applied one at a time:		N/A
	a) timers which limit the heating period shall be overridden to energize the heating circuit continuously;		N/A
	b) temperature control devices or circuits shall have single fault conditions applied such that control over the heater is lost. Over-temperature protection devices meeting the requirements of 14.3 are left operational during the test.		N/A
4.4.4.10	Safety interlock systems	No such systems.	N/A
4.4.4.11	Reverse d.c. connections	Considered.	P
	Unless the means of connection prevents reversal, external d.c. connections shall be connected with reverse polarity.		N/A
4.4.4.12	Voltage selector mismatch	No such devices.	N/A
	Equipment employing a voltage selector intended to be adjusted or set to match the supply voltage, is to have its voltage selector set in any position with the equipment connected to any of its rated supply circuits.		N/A
4.4.4.13	Mis-wiring with incorrect phase sequence or polarity	No any hazard occurred.	P



IEC/EN 62109-1, IEC/EN 62109-2			
Clause	Requirement – Test	Result – Remark	Verdict
	If connection to the a.c. supply with incorrect phase sequence or incorrect polarity of an earthed single-phase supply could result in a hazard, a mis-wiring test shall be applied.		P
4.4.4.14	Printed wiring board short-circuit test	See appended table.	P
	Where permitted by 7.3.7.7, functional insulation on PWBs, provided by spacings that are less than those specified in Table 7 and Table 8 (see 7.3.7.7) shall be type tested as described below.		P
	Each location of decreased spacings shall be short-circuited one at a time, and the shortcircuit shall be maintained until no further damage occurs. Overcurrent protection integral to the PCE, or required to be used with the PCE, is allowed to open. During and after each test, the PCE shall comply with the requirements of 4.4.3.		P
4.4.4.15 of IEC 62109-2	Fault-tolerance of protection for grid-interactive inverters	See below.	P
4.4.4.15.1 of IEC 62109-2	Fault-tolerance of residual current monitoring according to 4.8.3.5: the residual current monitoring system operates properly	See appended table.	P
	a) .- The inverter ceases to operate	See appended table.	P
	- Indicates a fault in accordance with §13.9		P
	- Disconnect from the mains		P
	- not re-connect after any sequence of removing and reconnecting PV power		P
	- not re-connect after any sequence of removing and reconnecting AC power		P
	- not re-connect after any sequence of removing and reconnecting both PV and AC power		P
	b) .- The inverter continues to operate	The inverter ceases to operate.	N/A
	- the residual current monitoring system operates properly under single fault condition		N/A
	- Indicates a fault in accordance with §13.9		N/A
	c)..- The inverter continues to operate regardless of loss of residual current monitoring functionality		N/A
	- not re-connect after any sequence of removing and reconnecting PV power		N/A
	- not re-connect after any sequence of removing and reconnecting AC power		N/A
	- not re-connect after any sequence of removing and reconnecting both PV and AC power		N/A
	- Indicates a fault in accordance with §13.9		N/A
4.4.4.15.2 of IEC 62109-2	Fault-tolerance of automatic disconnecting means	Two series relay in each line and may independent operation for each relay.	P
4.4.4.15.2.1 of IEC 62109-2	General		P
	The means provided for automatic disconnection of a grid-interactive inverter from the mains shall:		P



IEC/EN 62109-1, IEC/EN 62109-2			
Clause	Requirement – Test	Result – Remark	Verdict
	- disconnect all grounded current-carrying conductors from the mains	Disconnected all line conductors from the mains.	P
	- disconnect all ungrounded current-carrying conductors from the mains		P
	- be such that with a single fault applied to the disconnection means or to any other location in the inverter, at least basic insulation or simple separation is maintained between the PV array and the mains when the disconnecting means is intended to be in the open state.	The least basic insulation is maintained between the PV array and the mains when the relay on the open state.	P
4.4.4.15.2.2 of IEC 62109-2	Design of insulation or separation complies with requirements of 7.3.7 of Part 1: report here Part 1 comment and verdict.	Considered.	P
4.4.4.15.2.3 of IEC 62109-2	For non-isolated inverter, automatic checking of the isolation provided by a disconnect means after single fault.	The inverter automatic checking of the isolation after single fault occurred.	P
	If the check fail: - any still-functional disconnection means shall be left in the open position		P
	- at least basic or simple separation shall be maintained between the PV input and the mains		P
	- the inverter shall not start operation		P
	- the inverter shall indicate a fault in accordance with 13.9	The screen shown error information.	P
4.4.4.16 of IEC 62109-2	A stand-alone inverter with a transfer switch to transfer AC loads from the mains or other AC bypass source to the inverter output:	No such transfer switch	N/A
	- shall continue to operate normally		N/A
	- shall not present a risk of fire as the result of an out-of-phase transfer		N/A
	- shall not present a risk of shock as the result of an out-of-phase transfer		N/A
	- And having control preventing switching: components for malfunctioning		N/A
4.4.4.17 of IEC 62109-2	Cooling system failure – Blanketing test No hazards according to the criteria of sub-clause 4.4.3 of Part 1 shall result from blanketing the inverter This test is not required for inverters restricted to use only in closed electrical operating areas.	See appended table.	P
	Test stop condition: time duration value or stabilized temperature	Considered.	P
4.5	Humidity preconditioning		P
4.5.1	General		P
4.5.2	Conditions		P
4.6	Backfeed voltage protection	Considered.	P
4.6.1	Backfeed tests under normal conditions		P
	Each input source shall be tested separately by first disconnecting the source and then by deenergizing the source (if possible).		P
4.6.2	Backfeed tests under single-fault conditions	Considered.	P



IEC/EN 62109-1, IEC/EN 62109-2			
Clause	Requirement – Test	Result – Remark	Verdict
	The tests in 4.6.1 are repeated for each single fault condition under consideration. Faults to be applied are selected based on analysis of schematics of the circuitry with particular attention to devices that control or transfer energy between different sources.		P
4.6.3	Compliance with backfeed tests	Considered.	P
	The PCE is compliant with the requirements if during the tests in 4.6.1 and 4.6.2 no hazardous voltage or energy is present on the PCE terminals for the source under test. Measurements are taken 15 s or 1 s after the source is de-energized or disconnected, as follows:		P
	– 15 s for sources that are permanently connected;		P
	– 1 s for sources that are cord-connected or use connectors that can be opened without the use of a tool.	Permanently connected.	N/A
4.7	Electrical ratings tests	See appended table.	P
4.7.1	Input ratings	See appended table.	P
	While operating under the reference test conditions of 4.2.2, the measured continuous input current or power, as applicable, shall not exceed the marked input ratings by more than 10 %.	See appended table.	P
4.7.1.1	Measurement requirements for DC input ports		P
4.7.2	Output ratings		P
	While operating under the reference test conditions of 4.2.2, each output port of the PCE shall be capable of providing its marked output power or current ratings, as applicable, without overcurrent protective devices operating and without shutdown due to operation of overtemperature protection systems. The measured continuous output current or power, as applicable, shall not exceed the marked output ratings by more than 10 %.	Considered.	P
4.7.3 of IEC 62109-2	Measurement requirements for AC output ports for stand-alone inverters		P
4.7.4 of IEC 62109-2	Stand-alone Inverter AC output voltage and frequency		P
4.7.4.1 of IEC 62109-2	General		P
4.7.4.2 of IEC 62109-2	Steady state output voltage at nominal DC input The steady-state AC output voltage shall not be less than 90 % or more than 110 % of the rated nominal voltage with the inverter supplied with its nominal value of DC input voltage.	See appended table.	P



IEC/EN 62109-1, IEC/EN 62109-2			
Clause	Requirement – Test	Result – Remark	Verdict
4.7.4.3 of IEC 62109-2	Steady state output voltage across the DC input range The steady-state AC output voltage shall not be less than 85 % or more than 110 % of the rated nominal voltage with the inverter supplied with any value within the rated range of DC input voltage.	See appended table.	P
4.7.4.4 of IEC 62109-2	Load step response of the output voltage at nominal DC input The AC output voltage shall not be less than 85 % or more than 110 % of the rated nominal voltage for more than 1,5 s after application or removal of a resistive load.	See appended table.	P
4.7.4.5 of IEC 62109-2	Steady state output frequency The steady-state AC output frequency shall not vary from the nominal value by more than +4 % or –6 %.	See appended table.	P
4.7.5 of IEC 62109-2	Stand-alone inverter output voltage waveform		P
4.7.5.1 of IEC 62109-2	General		P
4.7.5.2 of IEC 62109-2	The AC output voltage waveform of a sinusoidal output stand-alone inverter shall have a total harmonic distortion (THD) not exceeding of 10 % and no individual harmonic at a level exceeding 6 %.	See appended table.	P
4.7.5.3 of IEC 62109-2	Non-sinusoidal output waveform requirements		N/A
4.7.5.3.1 of IEC 62109-2	General		N/A
4.7.5.3.2 of IEC 62109-2	The total harmonic distortion (THD) of the voltage waveform shall not exceed 40 %.		N/A
4.7.5.3.3 of IEC 62109-2	The slope of the rising and falling edges of the positive and negative half-cycles of the voltage waveform shall not exceed 10 V/μs measured between the points at which the waveform has a voltage of 10 % and 90 % of the peak voltage for that half-cycle.		N/A
4.7.5.3.4 of IEC 62109-2	The absolute value of the peak voltage of the positive and negative half-cycles of the waveform shall not exceed 1,414 times 110 % of the RMS value of the rated nominal AC output voltage.		N/A
4.7.5.4 of IEC 62109-2	Information requirements for non-sinusoidal waveforms The instructions provided with a stand-alone inverter not complying with 4.7.5.2 shall include the information in 5.3.2.6.		N/A
4.7.5.5 of IEC 62109-2	Output voltage waveform requirements for inverters for dedicated loads		N/A
	For an inverter that is intended only for use with a known dedicated load, the following requirements may be used as an alternative to the waveform requirements in 4.7.5.2 to 4.7.5.3.		N/A



IEC/EN 62109-1, IEC/EN 62109-2			
Clause	Requirement – Test	Result – Remark	Verdict
	The combination of the inverter and dedicated load shall be evaluated to ensure that the output waveform does not cause any hazards in the load equipment and inverter, or cause the load equipment to fail to comply with the applicable product safety standards.	Grid-interactive inverter.	N/A
	The inverter shall be marked with symbols 9 and 15 of Table C.1 of Part 1.	Grid-interactive inverter.	N/A
	The installation instructions provided with the inverter shall include the information in 5.3.2.13.	Grid-interactive inverter.	N/A
4.8 of IEC 62109-2	Additional tests for grid-interactive inverters	Considered.	P
4.8.1 of IEC 62109-2	General requirements regarding inverter isolation and array grounding	Non-isolation inverter.	N/A
	- Type of Array grounding supported		N/A
	- Inverter isolation		N/A
4.8.2 of IEC 62109-2	Array insulation resistance detection for inverters for ungrounded and functionally grounded arrays	Inverter checks the array isolation resistance before start up.	P
4.8.2.1 of IEC 62109-2	Array insulation resistance detection for inverters for ungrounded arrays	Considered.	P
	Inverter shall have means to measure DC insulation resistance from PV input (array) to ground before starting operation	Considered.	P
	Or Inverter shall be provided with instruction in accordance with 5.3.2.11.		P
	Measured DC insulation resistance:	See appended table.	P
	Inverter measurement circuit shall be capable of detecting insulation resistance below the limit value $R = V_{max}/30mA$ under normal conditions	Considered.	P
	Inverter measurement circuit shall be capable of detecting insulation resistance below the limit value $R = V_{max}/30mA$ with ground fault in the PV array	Considered.	P
	Isolated inverters shall indicate a fault if the insulation resistance is less than the limit value	The product is a non-isolated inverter.	N/A
	Isolated inverter fault indication maintained until insulation resistance has recovered to a value higher than the limit value		P
	Non-isolated inverters, or inverters with isolation not complying with the leakage current limits in the minimum inverter isolation requirements in Table 30:		P
	- shall indicate a fault in accordance with 13.9	Screen shown the error information.	P
	- shall not connect to the mains	Relay keep up opened.	P
4.8.2.2 of IEC 62109-2	Array insulation resistance detection for inverters for functionally grounded arrays	Inverter did not intend connected functionally grounded arrays.	N/A



IEC/EN 62109-1, IEC/EN 62109-2			
Clause	Requirement – Test	Result – Remark	Verdict
	a-1) The value of the total resistance, including the intentional resistance for array functional grounding, the expected insulation resistance of the array to ground, and the resistance of any other networks connected to ground (for example measurement networks) must not be lower than $R = (V_{MAX} PV/30 \text{ mA})$ ohms.		N/A
	a-2) The installation instructions shall include the information required in 5.3.2.12.		N/A
	b-1) As an alternative to a), or if a resistor value lower than in a) is used, the inverter shall incorporate means to detect, during operation, if the total current through the resistor and any networks (for example measurement networks) in parallel with it, exceeds the residual current values and times in Table 31		N/A
	b-2) Inverter shall either disconnect the resistor or limit the current by other means		N/A
	b-3) If the inverter is a non-isolated inverter, or has isolation not complying with the leakage current limits in the minimum inverter isolation requirements in Table 30, it shall also disconnect from the mains.		N/A
	c) The inverter shall have means to measure the DC insulation resistance from the PV input to ground before starting operation, in accordance with 4.8.2.1.		N/A
4.8.3 of IEC 62109-2	Array residual current detection		P
4.8.3.1 of IEC 62109-2	General	See below.	P
4.8.3.2 of IEC 62109-2	30 mA touch current type test for isolated inverters	Non-isolated inverters.	N/A
4.8.3.3 of IEC 62109-2	Fire hazard residual current type test for isolated inverters	Non-isolated inverters.	N/A
4.8.3.4 of IEC 62109-2	Protection by application of RCD's	The PCE provides an integrated RCDs.	N/A
	- The requirement for additional protection in 4.8.3.1 can be met by provision of an RCD with a residual current setting of 30 mA, located between the inverter and the mains..		N/A
	- The selection of the RCD type to ensure compatibility with the inverter must be made according to rules for RCD selection in Part 1.		N/A
	- The RCD provided integral to the inverter, or		N/A
	- The RCD provided by the installer if details of the rating, type, and location for the RCD are given in the installation instructions per 5.3.2.9.		N/A
4.8.3.5 of IEC 62109-2	Protection by residual current monitoring	See below.	P



IEC/EN 62109-1, IEC/EN 62109-2			
Clause	Requirement – Test	Result – Remark	Verdict
4.8.3.5.1of IEC 62109-2	General	The PCE provides an integrated RCDs.	P
	Where required by Table 30, the inverter shall provide residual current monitoring that functions whenever the inverter is connected to the mains with the automatic disconnection means closed.	The residual current will be measuring before start up.	P
	The residual current monitoring means shall measure the total (both a.c. and d.c. components) RMS current.	Considered.	P
	As indicated in Table 30 for different inverter types, array types, and inverter isolation levels, detection may be required for excessive continuous residual current, excessive sudden changes in residual current, or both, according to the following limits:	Considered.	P
	a) Continuous residual current: The inverter shall disconnect within 0,3 s and indicate a fault in accordance with 13.9 if the continuous residual current exceeds:	See appended table.	P
	- maximum 300 mA for inverters with continuous output power rating ≤ 30 kV;	See appended table.	P
	- maximum 10 mA per kVA of rated continuous output power for inverters with continuous output power rating > 30 kVA.		N/A
	The inverter may attempt to re-connect if the array insulation resistance meets the limit in 4.8.2.		P
	b) Sudden changes in residual current: The inverter shall disconnect from the mains within the time specified in Table 31	See appended table.	P
	The inverter indicates a fault in accordance with 13.9, if a sudden increase in the RMS residual current is detected exceeding the value in the table.	See appended table.	P
	- monitoring for the continuous condition in a) is not required for an inverter with isolation complying with 4.8.3.3;		P
	- monitoring for the sudden changes in b) is not required for an inverter with isolation complying with 4.8.3.2.		P
	The inverter may attempt to re-connect if the array insulation resistance meets the limit in 4.8.2.		P
4.8.3.5.2of IEC 62109-2	Test for detection of excessive continuous residual current: test repeated 5 times and time to disconnect shall not exceed 0,3 s.	See appended table.	P
4.8.3.5.3of IEC 62109-2	Test for detection of sudden changes in residual current repeated 5 times and each of the 5 results shall not exceed the time limit indicated in for each row (30mA, 60mA and 150mA) of Table 31.	See appended table.	P
4.8.3.6of IEC 62109-2	Systems located in closed electrical operating areas	No located in closed electrical operating areas.	N/A
	The protection against shock hazard is not required if the installation information provided with the inverter indicates the restriction for use in a closed electrical operating area, and		N/A



IEC/EN 62109-1, IEC/EN 62109-2			
Clause	Requirement – Test	Result – Remark	Verdict
	Installation information indicates what forms of shock hazard protection are and are not provided integral to the inverter, in accordance with 5.3.2.7.		N/A
	The inverter shall be marked as in 5.2.2.6.		N/A

5	MARKING AND DOCUMENTATION		P
5.1	Marking	See below	P
5.1.1	General	See below	P
	Equipment shall bear markings as specified in 5.1 and 5.2	The marking plate is on the outer surface of enclosure.	P
	Graphic symbols may be used and shall be in accordance with Annex C or IEC 60417 as applicable.	All used graphic symbols are in accordance with Annex C.	P
	Graphic symbols shall be explained in the documentation provided with the PCE.	The explanations are provided in the manual.	P
5.1.2	Durability of markings	See below	P
	Markings required by this clause to be located on the PCE shall remain clear and legible under conditions of NORMAL USE and resist the effects of cleaning agents specified by the manufacturer	After this test, the markings are clearly legible. There was neither loose nor curling on the edge of label.	P
5.1.3	Identification		P
	The equipment shall, as a minimum, be permanently marked with:	See below	P
	a) the name or trade mark of the manufacturer or supplier		P
	b) model number, name or other means to identify the equipment	The model name is provided on the label.	P
	c) a serial number, code or other marking allowing identification of manufacturing location and the manufacturing batch or date within a three month time period.	The serial number is provided on the label.	P
5.1.4	Equipment ratings		P
	Unless otherwise specified in another part of IEC 62109, the following ratings, as applicable shall be marked on the equipment:	See below	P
	– input voltage, type of voltage (a.c. or d.c.), frequency, and max. continuous current for each input	The input voltage, type of voltage (d.c.) and max. continuous current for each input are marked on the marking label.	P
	– output voltage, type of voltage (a.c. or d.c.), frequency, max. continuous current, and for a.c. outputs, either the power or power factor for each output	The output voltage type of voltage (a.c.), frequency, max. continuous current and power factor for each output are marked on the marking label.	P
	– the ingress protection (IP) rating as in 6.3 below	IP65 is marked on the label.	P



IEC/EN 62109-1, IEC/EN 62109-2			
Clause	Requirement – Test	Result – Remark	Verdict
5.1.4 of IEC 62109-2	Replacement: In addition to the markings required in other clauses of Part 1 and elsewhere in this Part 2, the ratings in Table 32 shall be plainly and permanently marked on the inverter, where it is readily visible after installation. Only those ratings that are applicable based on the type of inverter are required.	The rating mark plate has been placed on the front enclosure and it is visible after mounted.	P
	PV input ratings:	See below	P
	– V _{max} PV (absolute maximum) (d.c. V)	1100 d.c. V	P
	– I _{sc} PV (absolute maximum) (d.c. A)	36.0 /36.0 d.c. A	P
	a.c. output ratings:	See below	P
	– Voltage (nominal or range) (a.c. V)	400 a.c. V	P
	– Current (maximum continuous) (a.c. A)	SOFAR 15KTLX-G3: 3×23.9A SOFAR 17KTLX-G3: 3×27.1A SOFAR 20KTLX-G3: 3×31.9A SOFAR 22KTLX-G3: 3×35.1A SOFAR 24KTLX-G3: 3×38.3A	P
	– Frequency (nominal or range) (Hz)	50/60Hz	P
	– Power (maximum continuous) (W or VA)	SOFAR 15KTLX-G3: 16500VA SOFAR 17KTLX-G3: 18700VA SOFAR 20KTLX-G3: 22000VA SOFAR 22KTLX-G3: 24200VA SOFAR 24KTLX-G3: 26400VA	P
	– Power factor range	Adjustable (0.8 lead-0.8 lag)	P
	a.c. input ratings:	No a.c. input	N/A
	– Voltage (nominal or range) (a.c. V)		N/A
	– Current (maximum continuous) (a.c. A)		N/A
	– Frequency (nominal or range) (Hz)		N/A
	d.c. input (other than PV) ratings:	No d.c. input	N/A
	– Voltage (nominal or range) (d.c. V)		N/A
	– Current (maximum continuous) (d.c. A)		N/A
	d.c. output ratings:	No d.c. output	N/A
	– Voltage (nominal or range) (d.c. V)		N/A
	– Current (maximum continuous) (d.c. A)		N/A
	Protective class (I or II or III)	Class I	P
	Ingress protection (IP) rating per part 1	IP 65	P
5.1.5	Fuse identification	See below.	P
	Marking shall be located adjacent to each fuse or fuseholder, or on the fuseholder, or in another location provided that it is obvious to which fuse the marking applies, giving the fuse current rating and where fuses of different voltage rating value could be fitted, the fuse voltage rating.		N/A



IEC/EN 62109-1, IEC/EN 62109-2			
Clause	Requirement – Test	Result – Remark	Verdict
	Where fuses with special fusing characteristics such as time delay or breaking capacity are necessary, the type shall also be indicated		N/A
	For fuses not located in operator access areas and for soldered-in fuses located in operator access areas, it is permitted to provide an unambiguous cross-reference (for example, F1, F2, etc.) to the servicing instructions which shall contain the relevant information.	The fuse rating marked on the circuit diagram and maintenance manual.	P
5.1.6	Terminals, Connections, and Controls	See below	P
	If necessary for safety, an indication shall be given of the purpose of Terminals, connectors, controls, and indicators, and their various positions, including any connections for coolant fluids such as water and drainage. The symbols in Annex C may be used, and where there is insufficient space, symbol 9 of Annex C may be used.	The indications were provided adjacent to AC and DC quickConnector.	P
	Push-buttons and actuators of emergency stop devices, and indicator lamps used only to indicate a warning of danger or the need for urgent action shall be coloured red.	No such device	N/A
	A multiple-voltage unit shall be marked to indicate the particular voltage for which it is set when shipped from the factory. The marking is allowed to be in the form of a paper tag or any other nonpermanent material.	No such device	N/A
	A unit with d.c. terminals shall be plainly marked indicating the polarity of the connections, with:	See below	P
	– the sign “+” for positive and “-”, for negative; or	The “+” and “-” marking were provided adjacent to the DC input terminals.	P
	– a pictorial representation illustrating the proper polarity where the correct polarity can be unambiguously determined from the representation	No pictorial representation illustration used.	N/A
5.1.6.1	Protective Conductor Terminals		P
	The means of connection for the protective earthing conductor shall be marked with:	See below	P
	– symbol 7 of Annex C; or	The symbol of annex C was marked adjacent to the PE terminal.	P
	– the letters “PE”; or	Symbol 7 of Annex C was used.	P
	– the colour coding green-yellow.	Green-yellow wire was used as protective conductor.	P
5.1.7	Switches and circuit-breakers	Approved switch was used for all models.	P
	The on and off-positions of switches and circuit breakers shall be clearly marked. If a push-button switch is used as the power switch, symbols 10 and 16 of Annex C may be used to indicate the on-position, or symbols 11 and 17 to indicate the off-position, with the pair of symbols (10 and 16, or 11 and 17) close together.	“ON” indicated the on-position of DC switch. “OFF” indicated the off-position of DC switch.	P
5.1.8	Class II Equipment	Class I equipment.	N/A



IEC/EN 62109-1, IEC/EN 62109-2			
Clause	Requirement – Test	Result – Remark	Verdict
	Equipment using Class II protective means throughout shall be marked with symbol 12 of Annex C. Equipment which is only partially protected by DOUBLE INSULATION or REINFORCED INSULATION shall not bear symbol 12 of Table Annex C.		N/A
	Where such equipment has provision for the connection of an earthing conductor for functional reasons (see 7.3.6.4) it shall be marked with symbol 6 of Annex C		N/A
5.1.9	Terminal boxes for External Connections	No such parts.	N/A
	Where required by note 1 of Table 2 as a result of high temperatures of terminals or parts in the wiring compartment, there shall be a marking, visible beside the terminal before connection, of either:		N/A
	a) the minimum temperature Rating and size of the cable to be connected to the TERMINALS; or		N/A
	b) a marking to warn the installer to consult the installation instruction. Symbol 9 of Table D-1 is an acceptable marking		N/A
5.2	Warning markings		P
5.2.1	Visibility and legibility requirements for warning markings	See below	P
	Warning markings shall be legible, and shall have minimum dimensions as follows:		P
	– Printed symbols shall be at least 2.75 mm high	The symbols were at least 2.75 mm high.	P
	– Printed text characters shall be at least 1.5 mm high and shall contrast in colour with the background	The text characters were at least 1,5 mm high.	P
	– Symbols or text that are moulded, stamped or engraved in a material shall have a character height of at least 2,0 mm, and if not contrasting in colour from the background, shall have a depth or raised height of at least 0,5 mm.	The symbols or text are marking on the label.	N/A
	If it is necessary to refer to the instruction manual to preserve the protection afforded by the equipment, the equipment shall be marked with symbol 9 of Annex C	The symbol 9 of Annex C was provided on the label.	P
	Symbol 9 of Annex C is not required to be used adjacent to symbols that are explained in the manual	All symbols are explained in the manual.	P
5.2.2	Content for warning markings	See below	P
5.2.2.1	Ungrounded heatsinks and similar parts	All accessible metal parts were grounded.	N/A



IEC/EN 62109-1, IEC/EN 62109-2			
Clause	Requirement – Test	Result – Remark	Verdict
	An ungrounded heat sink or other part that may be mistaken for a grounded part and involves a risk of electric shock in accordance with 7.3 shall be marked with symbol 13 of Annex C, or equivalent. The marking may be on or adjacent to the heatsink and shall be clearly visible when the PCE is disassembled to the extent that a risk of contact with the heatsink exists.		N/A
5.2.2.2	Hot Surfaces		P
	A part of the PCE that exceeds the temperature limits specified in 4.3.2 shall be marked with symbol 14 of Annex C or equivalent.	The symbol 14 of Annex C provided on the warning label which located on the surface of enclosure.	P
5.2.2.3	Coolant	No coolant contained within the equipment.	N/A
	A unit containing coolant that exceeds 70 °C shall be legibly marked externally where readily visible after installation with symbol 15 of Annex C. The documentation shall provide a warning regarding the risk of burns from hot coolant, and either:		N/A
	a) statement that coolant system servicing is to be done only by SERVICE PERSONNEL, or		N/A
	b) instructions for safe venting, draining, or otherwise working on the cooling system, if these operations can be performed without OPERATOR access to HAZARDS internal to the equipment		N/A
5.2.2.4	Stored energy	See below	P
	Where required by 7.3.9.2 or 7.4.2 the PCE shall be marked with Symbol 21 of Annex C and the time to discharge capacitors to safe voltage and energy levels shall accompany the symbol.	The symbol 21 of Annex C and “5min” were provided on the label.	P
5.2.2.5	Motor guarding	Considered.	P
	Where required by 8.2 a marking shall be provided where it is visible to service personnel before removal of a guard, warning of the hazard and giving instructions for safe servicing (for example disconnection of the source before removing the guard).	Considered.	P
5.2.2.6 of IEC 62109-2	Inverters for closed electrical operating areas	Considered.	P
	Where required by 4.8.3.6, an inverter not provided with full protection against shock hazard on the PV array shall be marked with a warning that the inverter is only for use in a closed electrical operating area, and referring to the installation instructions.	Considered.	P
5.2.3	Sonic hazard markings and instructions	No any hazardous noise level from the equipment.	N/A
	If required by 10.2.1 a PCE shall:		N/A
	a) be marked to warn the operator of the sonic pressure hazard; or		N/A



IEC/EN 62109-1, IEC/EN 62109-2			
Clause	Requirement – Test	Result – Remark	Verdict
	b) be provided with installation instructions that specify how the installer can ensure that the sound pressure level from equipment at its point of use after installation, will not reach a value, which could cause a hazard. These instructions shall include the measured sound pressure level, and shall identify readily available and practicable protective materials or measures which may be used.		N/A
5.2.4	Equipment with multiple sources of supply	See below	P
	A PCE with connections for multiple energy sources shall be marked with symbol 13 of Annex C and the manual shall contain the information required in 5.3.4.	Marked with symbol 13 of Annex C and explain in user manual.	P
	The symbol shall be located on the outside of the unit or shall be prominently visible behind any cover giving access to hazardous parts.		P
5.2.5	Excessive touch current	No touch current exceeded 3,5mA a.c. Under any operation conditions.	N/A
	Where required by 7.3.6.3.7 the PCE shall be marked with symbol 15 of Annex C. See also 5.3.2 for information to be provided in the installation manual.		N/A
5.3	Documentation		P
5.3.1	General		P
	The documentation provided with the PCE shall provide the information needed for the safe operation, installation, and (where applicable) maintenance of the equipment. The documentation shall include the items required in 5.3.2 through 5.3.4, and the following:	Considered.	P
	a) explanations of equipment markings, including symbols used	Considered.	P
	b) location and function of terminals and controls	Considered.	P
	c) all ratings or specifications that are necessary to safely install and operate the PCE, including the following environmental ratings along with an explanation of their meaning and any resulting installation requirements:	Considered.	P
	– ENVIRONMENTAL CATEGORY as per 6.1	Outdoor	P
	– WET LOCATIONS classification for the intended external environment as per 6.1		P
	– POLLUTION DEGREE classification for the intended external environment as per 6.2	PD 3	P
	– INGRESS PROTECTION rating as per 6.3	IP65	P
	– Ambient temperature and relative humidity ratings	-30°C~+60°C	P
	– MAXIMUM altitude rating	Up to 2000m.	P



IEC/EN 62109-1, IEC/EN 62109-2			
Clause	Requirement – Test	Result – Remark	Verdict
	– OVERVOLTAGE CATEGORY assigned to each input and output port as per 7.3.7.1.2, accompanied by guidance regarding how to ensure that the installation complies with the required overvoltage categories;	PV side: OVCII AC side: OVCIII	P
	d) a warning that when the photovoltaic array is exposed to light, it supplies a d.c. voltage to the PCE	Considered.	P
5.3.1.1	Language		P
	Instructions related to safety shall be in a language that is acceptable in the country where the equipment is to be installed.	Considered.	P
5.3.1.2	Format		P
	In general, the documentation must be provided in printed form and is to be delivered with the equipment.	Considered.	P
	For equipment which requires the use of a computer for both installation and operation, documentation may be provided in electronic format without accompanying printed format.	Considered.	P
5.3.2	Information related to installation		P
	The documentation shall include installation and where applicable, specific commissioning instructions and, if necessary for safety, warnings against hazards which could arise during installation or commissioning of the equipment. The information provided shall include:	Considered.	P
	a) assembly, location, and mounting requirements;	Reference installation instruction.	P
	b) ratings and means of connection to each source of supply and any requirements related to wiring and external controls, colour coding of leads, disconnection means, or overcurrent protection needed, including instructions that the installation position shall not prevent access to the disconnection means;	Reference installation instruction.	P
	c) ratings and means of connection of any outputs from the PCE, and any requirements related to wiring and external controls, colour coding of leads, or overcurrent protection needed;	Reference installation instruction.	P
	d) explanation of the pin-out of connectors for external connections, unless the connector is used for a standard purpose (e.g. RS 232)	Reference installation instruction.	P
	e) ventilation requirements;	Reference installation instruction.	P
	f) requirements for special services, for example cooling liquid;	No special services.	N/A
	g) instructions and information relating to sound pressure level if required by 10.2.1;	Pressure level was not exceed 10.2.1 requirement.	N/A



IEC/EN 62109-1, IEC/EN 62109-2			
Clause	Requirement – Test	Result – Remark	Verdict
	h) where required by 14.8.1.3, instructions for the adequate ventilation of the room or location in which PCE containing vented or valve-regulated batteries is located, to prevent the accumulation of hazardous gases;		N/A
	i) tightening torque to be applied to wiring terminals;	Reference installation instruction.	P
	j) values of backfeed short-circuit currents available from the PCE on input and output conductors under fault conditions, if those currents exceeds the max. rated current of the circuit, as per 4.4.4.6;	The backfeed current was prevented.	N/A
	k) for each input to the PCE, the max value of short-circuit current available from the source, for which the PCE is designed; and	Considered.	P
	l) compatibility with RCD and RCM;	RCD is built-in the PCE.	P
	m) instructions for protective earthing, including the information required by 7.3.6.3.7 if a second protective earthing conductor is to be installed:	Reference installation instruction.	P
	n) where required by 7.3.8, the installation instructions shall include the following or equivalent wording:	RCD is built-in the PCE.	N/A
	“This product can cause a d.c. current in the external protective earthing conductor. Where a residual current-operated protective (RCD) or monitoring (RCM) device is used for protection in a case of direct or indirect contact, only an RCD or RCM of Type B is allowed on the supply side of this product.”		N/A
	o) for PCE intended to charge batteries, the battery nominal voltage rating, size, and type	The explanations are provided in the manual.	P
	p) PV array configuration information, such as ratings, whether the array is to be grounded or floating, any external protection devices needed, etc.	PV array should be floating configuration to be connected to PCE, relevant information had shown on the installation manual.	P
5.3.2.1 of IEC 62109-2	Ratings		P
	Subclause 5.3.2 of Part 1 requires the documentation to include ratings information for each input and output. For inverters this information shall be as in Table 33 below. Only those ratings that are applicable based on the type of inverter are required.		P
	PV input quantities :	See below	P
	– Vmax PV (absolute maximum) (d.c. V)	1100 d.c. V	P
	– PV input operating voltage range (d.c. V)	140-1000 d.c. V	P
	– Maximum operating PV input current (d.c. A)	26.0 /26.0 d.c. A	P



IEC/EN 62109-1, IEC/EN 62109-2			
Clause	Requirement – Test	Result – Remark	Verdict
	– Isc PV (absolute maximum) (d.c. A)	36.0 /36.0 d.c. A	P
	– Max. inverter backfeed current to the array (a.c. or d.c. A)	0A	P
	a.c. output quantities:	See below	P
	– Voltage (nominal or range) (a.c. V)	400a.c. V	P
	– Current (maximum continuous) (a.c. A)	SOFAR 15KTLX-G3: 3×23.9A SOFAR 17KTLX-G3: 3×27.1A SOFAR 20KTLX-G3: 3×31.9A SOFAR 22KTLX-G3: 3×35.1A SOFAR 24KTLX-G3: 3×38.3A	P
	– Current (inrush) (a.c. A, peak and duration)	0.8A/2us	P
	– Frequency (nominal or range) (Hz)	50Hz	P
	– Power (maximum continuous) (W or VA)	SOFAR 15KTLX-G3: 16500VA SOFAR 17KTLX-G3: 18700VA SOFAR 20KTLX-G3: 22000VA SOFAR 22KTLX-G3: 24200VA SOFAR 24KTLX-G3: 26400VA	P
	– Power factor range	Adjustable (0.8lead-0.8 lag)	P
	– Maximum output fault current (a.c. A, peak and duration or RMS)	200A/1us	P
	– Maximum output overcurrent protection (a.c. A)	45.0A	P
	a.c. input quantities:	No a.c input	N/A
	– Voltage (nominal or range) (a.c. V)		N/A
	– Current (maximum continuous) (a.c. A)		N/A
	– Current (inrush) (a.c. A, peak and duration)		N/A
	– Frequency (nominal or range) (Hz)		N/A
	d.c input (other than PV) quantities:	No d.c input	N/A
	– Voltage (nominal or range) (d.c. V)		N/A
	– Nominal battery voltage (d.c. V)		N/A
	– Current (maximum continuous) (d.c. A)		N/A
	d.c. output quantities:	No d.c output	N/A
	– Voltage (nominal or range) (d.c. V)		N/A
	– Nominal battery voltage (d.c. V)		N/A
	– Current (maximum continuous) (d.c. A)		N/A
	Protective class (I or II or III)	Class I	P
	Ingress protection (IP) rating per part 1	IP65	P
5.3.2.2 of IEC 62109-2	Grid-interactive inverter setpoints		N/A



IEC/EN 62109-1, IEC/EN 62109-2			
Clause	Requirement – Test	Result – Remark	Verdict
	For a grid-interactive unit with field adjustable trip points, trip times, or reconnect times, the presence of such controls, the means for adjustment, the factory default values, and the limits of the ranges of adjustability shall be provided in the documentation for the PCE or in other format such as on a website.	No adjustable setting available. Only the factory default values, however the adjustment shall be performed by distribution network operator.	N/A
5.3.2.3 of IEC 62109-2	Transformers and isolation	Transformerless PCE	N/A
	An inverter shall be provided with information to the installer regarding whether an internal isolation transformer is provided, and if so, what level of insulation (functional, basic, reinforced, or double) is provided by that transformer. The instructions shall also indicate what the resulting installation requirements are regarding such things as earthing or not earthing the array, providing external residual current detection devices, requiring an external isolation transformer, etc.		N/A
5.3.2.4 of IEC 62109-2	Transformers required but not provided	Transformerless PCE.	N/A
	An inverter that requires an external isolation transformer not provided with the unit, shall be provided with instructions that specify the configuration type, electrical ratings, and environmental ratings for the external isolation transformer with which it is intended to be used.		N/A
5.3.2.5 of IEC 62109-2	PV modules for non-isolated inverters		P
	Non-isolated inverters shall be provided with installation instructions that require PV modules that have an IEC 61730 Class A rating. If the maximum AC mains operating voltage is higher than the PV array maximum system voltage then the instructions shall require PV modules that have a maximum system voltage rating based upon the AC mains voltage.	Considered.	P
5.3.2.6 of IEC 62109-2	Non-sinusoidal output waveform information	Sinusoidal output waveform.	N/A
	The instruction manual for a stand-alone inverter not complying with 4.7.5.2 shall include a warning that the waveform is not sinusoidal, that some loads may experience increased heating, and that the user should consult the manufacturers of the intended load equipment before operating that load with the inverter. The inverter manufacturer shall provide information regarding what types of loads may experience increased heating, recommendations for maximum operating times with such loads, and shall specify the THD, slope, and peak voltage of the waveforms as determined by the testing in 4.7.5.3.2 through 4.7.5.3.4.		N/A



IEC/EN 62109-1, IEC/EN 62109-2			
Clause	Requirement – Test	Result – Remark	Verdict
5.3.2.7 of IEC 62109-2	Systems located in closed electrical operating areas	No such parts.	N/A
	Where required by 4.8.3.6, an inverter not provided with full protection against shock hazard on the PV array shall be provided with installation instructions requiring that the inverter and the array must be installed in closed electrical operating areas, and indicating which forms of shock hazard protection are and are not provided integral to the inverter (for example the RCD, isolation transformer complying with the 30 mA touch current limit, or residual current monitoring for sudden changes).		N/A
5.3.2.8 of IEC 62109-2	Stand-alone inverter output circuit bonding	No such equipment.	N/A
	Where required by 7.3.10, the documentation for an inverter shall include the following:		N/A
	– if output circuit bonding is required but is not provided integral to the inverter, the required means shall be described in the installation instructions, including which conductor is to be bonded and the required current carrying capability or cross-section of the bonding means;		N/A
	– if the output circuit is intended to be floating, the documentation for the inverter shall indicate that the output is floating.		N/A
5.3.2.9 of IEC 62109-2	Protection by application of RCD's	See below.	N/A
	Where the requirement for additional protection in 4.8.3.1 is met by requiring an RCD that is not provided integral to the inverter, as allowed by 4.8.3.4, the installation instructions shall state the need for the RCD, and shall specify its rating, type, and required circuit location.	The RCD protection is provided integral to the inverter.	N/A
5.3.2.10 of IEC 62109-2	Remote indication of faults	See below.	P
	The installation instructions shall include an explanation of how to properly make connections to (where applicable), and use, the electrical or electronic fault indication required by 13.9.	The instructions are specified in section "Warning List" of the product manual.	P
5.3.2.11 of IEC 62109-2	External array insulation resistance measurement and response	Subclause 4.8.2.1 compliance.	N/A
	The installation instructions for an inverter for use with ungrounded arrays that does not incorporate all the aspects of the insulation resistance measurement and response requirements in 4.8.2.1, must include:	The PCE incorporates array insulation resistance measurement.	N/A



IEC/EN 62109-1, IEC/EN 62109-2			
Clause	Requirement – Test	Result – Remark	Verdict
	– for isolated inverters, an explanation of what aspects of array insulation resistance measurement and response are not provided, and an instruction to consult local regulations to determine if any additional functions are required or not;		N/A
	– for non-isolated inverters:		N/A
	• an explanation of what external equipment must be provided in the system, and		N/A
	• what the setpoints and response implemented by that equipment must be, and		N/A
	• how that equipment is to be interfaced with the rest of the system.		N/A
5.3.2.12 of IEC 62109-2	Array functional grounding information	No such part.	N/A
	Where approach a) of 4.8.2.2 is used, the installation instructions for the inverter shall include all of the following:		N/A
	a) the value of the total resistance between the PV circuit and ground integral to the inverter;		N/A
	b) the minimum array insulation resistance to ground that system designer or installer must meet when selecting the PV panel and system design, based on the minimum value that the design of the PV functional grounding in the inverter was based on;		N/A
	c) the minimum value of the total resistance $R = V_{MAX} PV/30 \text{ mA}$ that the system must meet, with an explanation of how to calculate the total;		N/A
	d) a warning that there is a risk of shock hazard if the total minimum resistance requirement is not met.		N/A
5.3.2.13 of IEC 62109-2	Stand-alone inverters for dedicated loads		N/A
	Where the approach of 4.7.5.5 is used, the installation instructions for the inverter shall include a warning that the inverter is only to be used with the dedicated load for which it was evaluated, and shall specify the dedicated load.		N/A
5.3.2.14 of IEC 62109-2	Identification of firmware version(s)	See below	P
	An inverter utilizing firmware for any protective functions shall provide means to identify the firmware version. This can be a marking, but the information can also be provided by a display panel, communications port or any other type of user interface.	The firmware version is displayed on LCD display panel and disclosed by communication interface.	P
5.3.3	Information related to operation		P



IEC/EN 62109-1, IEC/EN 62109-2			
Clause	Requirement – Test	Result – Remark	Verdict
	Instructions for use shall include any operating instructions necessary to ensure safe operation, including the following, as applicable:	See below	P
	– Instructions for adjustment of controls including the effects of adjustment;	Provided in the instruction manual.	P
	– Instructions for interconnection to accessories and other equipment, including indication of suitable accessories, detachable parts and any special materials;	Provided in the instruction manual.	P
	– Warnings regarding the risk of burns from surfaces permitted to exceed the temperature limits of 4.3.2 and required operator actions to reduce the risk; and	The temperature of surfaces did not exceed the limit of 4.3.2, however the 14 symbol was provided on the label.	P
	– Instructions, that if the equipment is used in a manner not specified by the manufacturer, the protection provided by the equipment may be impaired.	Provided in the user's manual.	P
5.3.4	Information related to maintenance		P
	Maintenance instructions shall include the following:		P
	– Intervals and instructions for any preventive maintenance that is required to maintain safety (for example air filter replacement or periodic re-tightening of terminals);	Provided in the user's manual.	P
	– Instructions for accessing operator access areas, if any are present, including a warning not to enter other areas of the equipment;	Provided in the user's manual.	P
	– Part numbers and instructions for obtaining any required operator replaceable parts;	No any operator replaceable parts. Only for authorized service personnel.	N/A
	– Instructions for safe cleaning (if recommended)	Provided in the user's manual.	P
	– Where there is more than one source of supply energizing the PCE, information shall be provided in the manual to indicate which disconnect device or devices are required to be operated in order to completely isolate the equipment.	Provided in the user's manual.	P
5.3.4.1	Battery maintenance		N/A
	Where required by 14.8.5, the documentation shall include the applicable items from the following list of instructions regarding maintenance of batteries:	No batteries.	N/A
	– Servicing of batteries should be performed or supervised by personnel knowledgeable about batteries and the required precautions	No batteries.	N/A
	– When replacing batteries, replace with the same type and number of batteries or battery packs	No batteries.	N/A
	– General instructions regarding removal and installation of batteries	No batteries.	N/A



IEC/EN 62109-1, IEC/EN 62109-2			
Clause	Requirement – Test	Result – Remark	Verdict
	– CAUTION: Do not dispose of batteries in a fire. The batteries may explode.	No batteries.	N/A
	– CAUTION: Do not open or damage batteries. Released electrolyte is harmful to the skin and eyes. It may be toxic.	No batteries.	N/A
	– CAUTION: A battery can present a risk of electrical shock and high short-circuit current. The following precautions should be observed when working on batteries:	No batteries.	N/A
	a) Remove watches, rings, or other metal objects.	No batteries.	N/A
	b) Use tools with insulated handles.	No batteries.	N/A
	c) Wear rubber gloves and boots.	No batteries.	N/A
	d) Do not lay tools or metal parts on top of batteries	No batteries.	N/A
	e) Disconnect charging source prior to connecting or disconnecting battery terminals	No batteries.	N/A
	f) Determine if battery is inadvertently grounded. If inadvertently grounded, remove source from ground. Contact with any part of a grounded battery can result in electrical shock. The likelihood of such shock can be reduced if such grounds are removed during installation and maintenance (applicable to equipment and remote battery supplies not having a grounded supply circuit).	No batteries.	N/A

6	ENVIRONMENTAL REQUIREMENTS AND CONDITIONS		P
	The manufacturer shall rate the PCE for the following environmental conditions:	Considered	P
	– ENVIRONMENTAL CATEGORY, as in 6.1 below	The PCE is for outdoor and indoor use.	P
	– Suitability for WET LOCATIONS or not	The PCE is for outdoor and indoor use.	P
	– POLLUTION DEGREE rating in 6.2 below	PD2 for internal environment, PD3 for external environment.	P
	– INGRESS PROTECTION (IP) rating, as in 6.3 below	IP65	P
	– Ultraviolet (UV) exposure rating, as in 6.4 below	The displayer panel and connection terminals could protect against UV radiation.	P
	– Ambient temperature and relative humidity ratings, as in 6.5 below	See 6.5.	P
6.1	Environmental categories and minimum environmental conditions		P
6.1.1	Outdoor	The PCE is for outdoor	P
6.1.2	Indoor, unconditioned		N/A
6.1.3	Indoor, conditioned		N/A



IEC/EN 62109-1, IEC/EN 62109-2			
Clause	Requirement – Test	Result – Remark	Verdict
6.2	Pollution degree	PD2 for internal environment, PD3 for external environment.	P
6.3	Ingress Protection	IP65	P
6.4	UV exposure	The PCE is for outdoor	P
6.5	Temperature and humidity	-30°C~+60°C, 0%~100% R.H.	P

7 PROTECTION AGAINST ELECTRIC SHOCK AND ENERGY HAZARDS			P
7.1	General	See below	P
7.2	Fault conditions	Refer to table 4,4.	P
7.3	Protection against electric shock		P
7.3.1	General	See below	P
7.3.2	Decisive voltage classification		P
7.3.2.1	Use of decisive voltage class (DVC)		P
7.3.2.2	Limits of DVC (according table 6)	DVC-C is classified for d.c. input and a.c. output circuit. DVC-A is classified for circuitry of communication ports.	P
7.3.2.3	Short-terms limits of accessible voltages under fault conditions		N/A
7.3.2.4	Requirements for protection (according table 7)	Considered	P
7.3.2.5	Connection to PELV and SELV circuits	DVC-A is classified for communication ports.	P
7.3.2.6	Working voltage and DVC	See below	P
7.3.2.6.1	General	Considered	P
7.3.2.6.2	AC working voltage (see Figure 2)	Considered	P
7.3.2.6.3	DC working voltage (see Figure 3)	Considered	P
7.3.2.6.4	Pulsating working voltage (see Figure 4)	Considered	P
7.3.3	protective separation		P
	Protective separation shall be achieved by:	See below	P
	<ul style="list-style-type: none"> ▪ double or reinforced insulation, or 	The double or reinforced insulation was provided between: 1) DC input circuits and communication circuits; 2) AC output circuits and communication circuits.	P
	<ul style="list-style-type: none"> ▪ protective screening, i.e. by a conductive screen connected to earth by protective bonding in the PCE, or connected to the protective earth conductor itself, whereby the screen is separated from live parts by at least basic insulation, or 	All accessible metal parts were earthed and separated from live parts by at least basic insulation.	P
	<ul style="list-style-type: none"> ▪ protective impedance comprising limitation of current per 7.3.5.3 and of discharged energy per 7.3.5.4, or 	No such device.	N/A
	<ul style="list-style-type: none"> ▪ limitation of voltage according to 7.3.5.4. 	No such device.	N/A
	The protective separation shall be fully and effectively maintained under all conditions of intended use of the PCE	Considered	P
7.3.4	Protection against direct contact		P
7.3.4.1	General	See below	P



IEC/EN 62109-1, IEC/EN 62109-2			
Clause	Requirement – Test	Result – Remark	Verdict
	Protection against direct contact is employed to prevent persons from touching live parts that do not meet the requirements of 7.3.5 and shall be provided by one or more of the measure given in 7.3.4.2 (enclosures and barriers) and 7.3.4.3 (insulation).	See 7.3.4.2 and 7.3.4.3	P
	Open type sub-assemblies and devices do not require protective measures against direct contact but the instruction provided with the equipment must indicate that such measures must be provided in the end equipment or in the installation.	No such device.	N/A
	Product intended for installation in CLOSED ELECTRICAL OPERATING AREAS, (see 3.9) need not have protective measures against direct contact, except as required by 7.3.4.2.4.	No such device.	N/A
7.3.4.2	Protection by means of enclosures and barriers		P
	The following requirements apply where protection against contact with live parts is provided by enclosures or barriers, not by insulation in accordance with 7.3.4.3.	Considered	P
7.3.4.2.1	General	See below	P
	Parts of enclosures and barriers that provide protection in accordance with these requirements shall not be removable without the use of a tool (see 7.3.4.2.3).	Considered	P
	Polymeric materials used to meet these requirements shall also meet the requirements of 13.6	Considered	P
7.3.4.2.2	Access probe criteria		P
	Protection is considered to be achieved when the separation between the test probes and live parts, when tested as described below, is as follows:	See below	P
	a) decisive voltage classification A, (DVC A) - the probe may touch the live parts	Considered	P
	b) decisive voltage classification B, (DVC B) - the probe must not touch bare live parts	No DVC-B in the PCE.	N/A
	c) decisive voltage classification C, (DVC C) – the probe must have adequate clearance to live parts, based on the clearance for Basic insulation using the recurring peak working voltage involved,	Considered	P
7.3.4.2.3	Access probe tests		P
	Compliance with 7.3.4.2.1 is checked by all of the following:		P
	a) Inspection; and	Considered	P



IEC/EN 62109-1, IEC/EN 62109-2			
Clause	Requirement – Test	Result – Remark	Verdict
	b) Tests with the test finger (Figure D.1) and test pin (Figure D.2) of 0E, the results of which shall comply with the requirements of 7.3.4.2.1 a), b), and c) as applicable. Probe tests are performed on openings in the enclosures after removal of parts that can be detached or opened by an operator without the use of a tool, including fuseholders, and with operator access doors and covers open. It is permitted to leave lamps in place for this test. Connectors that can be separated by an operator without use of a tool, shall also be tested during and after disconnection. Any movable parts are to be put in the most unfavorable position.	Considered	P
	The test finger and the test pin are applied as above, without appreciable force, in every possible position, except that floor-standing equipment having a mass exceeding 40 kg is not tilted.	Considered	P
	Equipment intended for building-in or rack mounting, or for incorporation in larger equipment, is tested with access to the equipment limited according to the method of mounting detailed in the installation instructions.	No a built-in or rack mounting equipment.	N/A
	c) Openings preventing the entry of the jointed test finger (Figure D-1 of Annex D) during test b) above, are further tested by means of straight unjointed test finger (Figure D-3 of Annex D), applied with a force of 30 N. If the unjointed finger enters, the test with the jointed finger is repeated except that the finger is applied using any necessary force up to 30 N.	Considered.	P
	d) In addition to a) – c) above, top surfaces of enclosure shall be tested with the IP3X probe of IEC 60529. The test probe shall not penetrate the top surface of the enclosure when probed from the vertical direction $\pm 5^\circ$ only.	Considered.	P
7.3.4.2.4	Service access areas	The PCE is not allowed to remove the covers during installation and maintenance when PCE energized.	P
7.3.4.3	Protection by means of insulation of live parts	See below	N/A
	Where the requirements of 7.3.4.2 are not met, live parts shall be provided with insulation if:	The requirements of 7.3.4.2 are met.	N/A
	– their working voltage is greater than the maximum limit of decisive voltage class A, or		N/A
	– for a DVC A or B circuit, protective separation from adjacent circuit of DVC C is not provided (see note “†” under Table 7)		N/A
7.3.5	Protection in case of direct contact		N/A
7.3.5.1	General		P



IEC/EN 62109-1, IEC/EN 62109-2			
Clause	Requirement – Test	Result – Remark	Verdict
	Protection in case of direct contact is required to ensure that contact with live parts does not produce a shock hazard.	See below	P
	The protection against direct contact according to 7.3.4 is not required if the circuit contacted is separated from other circuits according to 7.3.2.3, and:	Considered	P
	– is of decisive voltage class A and complies with 7.3.5.2, or	Only DVC-A classified circuits can be touched directly, see also 7.3.5.2.	P
	– is provided with protective impedance according to 7.3.5.3, or		N/A
	– is limited in voltage according to 7.3.5.4		N/A
	In addition to the measures as given in 7.3.5.2 to 7.3.5.4, it shall be ensured that in the event of error or polarity reversal of connectors no voltages that exceed DVC A can be connected into a circuit with protective separation. This applies for example to plug-in-sub-assemblies or other plug-in devices which can be plugged-in without the use of a tool (key) or which are accessible without the use of a tool.	Considered	P
	Conformity is checked by visual inspection and trial insertion.	Considered	P
7.3.5.2	Protection using decisive voltage class A	Considered	P
7.3.5.3	Protection by means of protective impedance	No such parts.	N/A
	Circuits and conductive parts do not require protection against direct contact if any connection to circuits of DVC-B or DVC-C is through protective impedance, and the accessible circuit or part is otherwise provided with protective separation from circuits of DVC-B or DVC-C according 7.3.3.		N/A
7.3.5.3.1	Limitation of current through protective impedance	No such parts.	N/A
	The current available through protective impedance to earth and between simultaneously accessible parts, measured at the accessible live parts, shall not exceed a value of 3,5 mA a.c. or 10 mA d.c. under normal and single-fault conditions.		N/A
7.3.5.3.2	Limitation of discharging energy through protective impedance	No such parts.	N/A
	The discharging energy available between simultaneously accessible parts protected by protective impedance shall not exceed the charging voltage and capacitance limits given in Table 9, which applies to both wet and dry locations, under normal and single fault conditions. Refer to figure 8.		N/A
7.3.5.4	Protection by means of limited voltages	No such parts.	N/A
	That portion of a circuit that has its voltage reduced to DVC-A by a voltage divider that complies with the following requirements, and that is otherwise provided with protective separation from circuits of DVC-B or DVC-C according to 7.3.3, does not require protection against direct contact.		N/A



IEC/EN 62109-1, IEC/EN 62109-2			
Clause	Requirement – Test	Result – Remark	Verdict
	The voltage divider shall be designed so that under normal and single fault conditions, including faults in the voltage division circuit, the voltage across the output of the voltage divider does not exceed the limit for DVC-A.		N/A
	This type of protection shall not be used in case of protective class II or unearthed circuits, because it relies on protective earth being connected.		N/A
7.3.6	Protection against indirect contact		P
7.3.6.1	General	See below	P
	Protection against indirect contact is required to prevent shock- hazardous current being accessible from conductive parts during an insulation failure. This protection shall comply with the requirements for protective class I (basic insulation plus protective earthing), class II (double or reinforced insulation) or class III (limitation of voltages)	The earthing metal enclosure is complied with protective class I and the circuit of communication is complied with protective class II for accessible communication ports.	P
	That part of a PCE meets the requirements of 7.3.6.2 and 7.3.6.3 is defined as protective class I	Considered	P
	That part of a PCE meets the requirements of 7.3.6.4 is defined as protective class II.	Considered	P
	That part of PCE which meets the requirements of decisive voltage class A and in which no hazardous voltages are derived, is defined as protective class III. No shock hazard is present in such circuits.		N/A
	Where protection against indirect contact is dependent on means provided during installation, the installation instructions shall provide details of the required means and shall indicate the associated hazards.	Considered	P
7.3.6.2	Insulation between live parts and accessible conductive parts	Considered	P
	Accessible conductive parts of equipment shall be separated from live parts by insulation meeting the requirements of Table 7 or by clearances as specified in 7.3.7.4 and creepages as specified in 7.3.7.5	The clearances specified in 7.3.7.4 and creepage specified in 7.3.7.5 are complied.	P
7.3.6.3	Protective class I – Protective bonding and earthing	See below	P
7.3.6.3.1	General		P
	Equipment of protective class I shall be provided with protective earthing, and with protective bonding to ensure electrical contact between accessible conductive parts and the means of connection for the external protective earthing conductor, except bonding is not required for:	See below	P
	a) accessible conductive parts that are protected by one of the measures in 7.3.5.2 to 7.3.5.4, or	DVC-A classified circuit is considered.	P
	b) accessible conductive parts are separated from live parts of DVC-B or -C using double or reinforced insulation.	Communication circuits are separated from live parts used double or reinforced insulation.	P
7.3.6.3.2	Requirements for protective bonding		P
	Electrical contact with the means of connection of the external protective earthing conductor shall be achieved by one or more of the following means:	See below	P



IEC/EN 62109-1, IEC/EN 62109-2			
Clause	Requirement – Test	Result – Remark	Verdict
	a) through direct metallic contact;	The connection of external protective earthing conductor is direct metal contact via a terminal with screw.	P
	b) through other conductive parts which are not removed when the PCE or sub-units are used as intended ;	See above	N/A
	c) through a dedicated protective bonding conductor;	Protective earthing terminal be used.	P
	d) through other metallic components of the PCE		N/A
	Where direct metallic contact is used and one or both of the parts involved is painted or coated, the paint or coating shall be removed in the area of contact, or reliably penetrated, to ensure metal to metal contact.	No painted and coated exsited.	P
	For moving or removable parts, hinges or sliding contacts designed and maintained to have a low resistance are examples of acceptable means if they comply with the requirements of 7.3.6.3.3.	No such parts.	N/A
	Metal ducts of flexible or rigid construction and metallic sheaths shall not be used as protective bonding conductors, unless the device or material has been investigated as suitable for protective bonding purposes.	No such parts.	N/A
7.3.6.3.3	Rating of protective bonding	The alternative of 7.3.6.3.5 is considered.	P
	Protective bonding shall withstand the highest thermal and dynamic stresses that can occur to the PCE item(s) concerned when they are subjected to a fault connecting live parts to accessible conductive parts. The protective bonding shall remain effective for as long as a fault to the accessible conductive parts persists or until an upstream protective device removes power from the part.		N/A
	Protective bonding shall meet following requirements:		N/A
	a) For PCE with an overcurrent protective device rating of 16 A or less, the impedance of the protective bonding means shall not exceed 0,1 Ω during or at the end of the test below.		N/A
	b) For PCE with an overcurrent protective device rating of more than 16 A, the voltage drop in the protective bonding test shall not exceed 2,5 V during or at the end of the test below.		N/A
	As alternative to a) and b) the protective bonding may designed according to the requirements for the external protective earthing conductor in 7.3.6.3.5, in which case no testing is required.	The alternative of 7.3.6.3.5 was considered.	P



IEC/EN 62109-1, IEC/EN 62109-2			
Clause	Requirement – Test	Result – Remark	Verdict
	The impedance of protective bonding means shall be checked by passing a test current through the bond for a period of time as specified below. The test current is based on the rating of the overcurrent protection for the equipment or part of the equipment under consideration, as follows:		N/A
	a) For pluggable equipment type A, the overcurrent protective device is that provided external to the equipment (for example, in the building wiring, in the mains plug or in an equipment rack);		N/A
	b) For pluggable equipment type B and fixed equipment, the maximum rating of the overcurrent protective device specified in the equipment installation instructions to be provided external to the equipment;		N/A
	c) For a circuit or part of the equipment for which an overcurrent protective device is provided as part of the equipment, the rating of the provided overcurrent device.		N/A
	Voltages are measured from the protective earthing terminal to all parts whose protective bonding means are being considered. The impedance of the protective earthing conductor is not included in the measurement. However, if the protective earthing conductor is supplied with the equipment, it is permitted to include the conductor in the test circuit but the measurement of the voltage drop is made only from the main protective earthing terminal to the accessible part required to be earthed.		N/A
	On equipment where the protective earth connection to a subassembly or to a separate unit is part of a cable that also supplies power to that subassembly or unit, the resistance of the protective bonding conductor in that cable is not included in the protective bond impedance measurements for the subassembly or separate unit, as shown in Figure 11. However, this option is only permitted if the cable is protected by a suitably rated protective device that takes into account the size of the conductor. Otherwise the impedance of the protective bonding conductor between the separate units is to be included, by measuring to the protective earthing terminal where the power source enters the first unit in the system, as shown in Figure 12.		N/A
7.3.6.3.3.1	Test current, duration, and acceptance criteria	The alternative of 7.3.6.3.5 was considered.	N/A
	The test current, duration of the test and acceptance criteria are as follows:		N/A



IEC/EN 62109-1, IEC/EN 62109-2			
Clause	Requirement – Test	Result – Remark	Verdict
	a) For PCE with an overcurrent protective device rating of 16 A or less, the test current is 200% of the overcurrent protective device rating, but not less than 32 A, applied for 120s. The impedance of the protective bonding means during and at the end of the test shall not exceed 0,1 Ω.		N/A
	b) For PCE with an overcurrent protective device rating of more than 16 A, the test current is 200% of the overcurrent protective device rating and the duration of the test is as shown in Table 10 below. The voltage drop in the protective bonding means, during and at the end of the test, shall not exceed 2,5 V.		N/A
	c) During and after the test, there shall be no melting, loosening, or other damage that would impair the effectiveness of the protective bonding means.		N/A
	The test current is derived from an a.c or d.c supply source, the output of which is not earthed.		N/A
	As an alternative to Table 10, where the time-current characteristic of the overcurrent protective device that limits the fault current in the protective bonding means is known because the device is either provided in the equipment or fully specified in the installation instructions, the test duration may be based on that specific device's time-current characteristic,. The tests are conducted for a duration corresponding to the 200% current value on the time-current characteristic.		N/A
7.3.6.3.4	Protective bonding impedance (routine test)	The alternative of 7.3.6.3.5 was considered.	N/A
	If the continuity of the protective bonding is achieved at any point by a single means only (for example a single conductor or single fastener), or if the PCE is assembled at the installation location, then the impedance of the protective bonding shall also be tested as a routine test. The test shall be as in 7.3.6.3.3, except for the following:		N/A
	<ul style="list-style-type: none"> ▪ the test current may be reduced to any convenient value greater than 10 A sufficient to allow measurement or calculation of the impedance of the protective bonding means: 		N/A
	<ul style="list-style-type: none"> ▪ the test duration may be reduced to no less than 2 s 		N/A
	For equipment subject to the type test in 7.3.6.3.3.1a), the impedance during the routine test shall not exceed 0,1Ω.		N/A
	For equipment subject to the type test in 7.3.6.3.3.1b) the impedance during the routine test shall not exceed 2,5 V divided by the test current required by 7.3.6.3.3.1b).		N/A



IEC/EN 62109-1, IEC/EN 62109-2			
Clause	Requirement – Test	Result – Remark	Verdict
7.3.6.3.5	External protective earthing conductor	See below	P
	A protective earthing conductor shall be connected at all times when power is supplied to PCE of protective class I. Unless local wiring regulations state otherwise, the protective earthing conductor cross-sectional area shall be determined from Table 11 or by calculation according to IEC 60364-5-54.	The protective earthing conductor is fixed permanently and the minimum cross-sectional area is 4mm ² for cable of phase and protective earthing. Only qualified personnel can install the protective earthing.	P
	If the external protective earthing conductor is routed through a plug and socket or similar means of disconnection, it shall not be possible to disconnect it unless power is simultaneously removed from the part to be protected.	The external protection earthing conductor just be removed when the power line is simultaneously removed from mains.	P
	The cross-sectional area of every external protective earthing conductor which does not form part of the supply cable or cable enclosure shall, in any case, be not less than:		N/A
	<ul style="list-style-type: none"> ▪ 2,5 mm² if mechanical protection is provided; 		N/A
	<ul style="list-style-type: none"> ▪ 4 mm² if mechanical protection is not provided. 	External a minimum cross-sectional area is 6mm ² conductors . The explanations are provided in the manual.	P
	For cord-connected equipment, provisions shall be made so that the external protective earthing conductor in the cord shall, in the case of failure of the strain-relief mechanism, be the last conductor to be interrupted.		N/A
7.3.6.3.6	Means of connection for the external protective earthing conductor	External protective earthing conductors connect to the enclosure body.	P
7.3.6.3.6.1	General		P
	<p>The means of connection for the external protective earthing conductor shall be located near the terminals for the respective live conductors. The means of connections shall be corrosion-resistant and shall be suitable for the connection of cables according to 7.3.6.3.5.</p> <p>The means of connection for the protective earthing conductor shall not be used as a part of the mechanical assembly of the equipment or for other connections.</p> <p>A separate means of connection shall be provided for each external protective earthing conductor. Connection and bonding points shall be so designed that their current-carrying capacity is not impaired by mechanical, chemical, or electrochemical influences. Where enclosures and/or conductors of aluminium or aluminium alloys are used, particular attention should be given to the problems of electrolytic corrosion.</p>	Considered	P
	The means of connection for the protective earthing conductor shall be permanently marked with:		P
	<ul style="list-style-type: none"> • symbol 7 of Annex C; or 		P



IEC/EN 62109-1, IEC/EN 62109-2			
Clause	Requirement – Test	Result – Remark	Verdict
	<ul style="list-style-type: none"> the colour coding green-yellow 		P
	Marking shall not be done on easily changeable parts such as screws.		P
7.3.6.3.7	Touch current in case of failure of the protective earthing conductor	See below	P
	The requirements of this sub-clause shall be satisfied to maintain safety in case of damage to or disconnection of the protective earthing conductor.		P
	For pluggable equipment type A, the touch current measured in accordance with 7.5.4 shall not exceed 3,5 mA a.c. or mA d.c.		N/A
	For all other PCE, one or more of the following measure shall be applied, unless the touch current measured in accordance with 7.5.4 using the test network of IEC 60990 test figure 4 shall not exceed 3,5 mA a.c. or 10 mA d.c.	Living part and com. Port: 0.08mA Live part and metal enclosure: 2.9mA	P
	a) Permanently connected wiring, and:		N/A
	<ul style="list-style-type: none"> a cross-section of the protective earthing conductor of at least 10 mm² Cu or 16 mm² Al; or 		N/A
	<ul style="list-style-type: none"> automatic disconnection of the supply in case of discontinuity of the protective earthing conductor; or 		N/A
	<ul style="list-style-type: none"> provision of an additional terminal for a second protective earthing conductor of the same cross-sectional area as the original protective earthing conductor and installation instruction requiring a second protective earthing conductor to be installed or 		N/A
	b) Connection with an industrial connector according to IEC 60309 and a minimum protective earthing conductor cross-section of 2,5 mm ² as part of a multi-conductor power cable. Adequate strain relief shall be provided.		N/A
	In addition, the caution symbol 15 of Annex C shall be fixed to the product and the installation manual shall provide details of the protective earthing measures required in the installation as required in 5.3.2.		N/A
	When it is intended and allowed to connect two or more PCEs in parallel using one common PE conductor, the above touch current requirements apply to the maximum number of the PCEs to be connected in parallel, unless one of the measures in a)		N/A
	or b) above is used. The maximum number of parallel PCEs is used in the testing and has to be stated in the installation manual.		N/A
7.3.6.4	Protective Class II – Double or Reinforced Insulation	See below	P



IEC/EN 62109-1, IEC/EN 62109-2			
Clause	Requirement – Test	Result – Remark	Verdict
	Equipment or parts of equipment designed for protective class II shall have insulation between live parts and accessible surfaces in accordance with 7.3.4.3. The following requirements also apply:	Accessible communication circuits and hazardous live parts were separated by reinforced insulation.	P
	<ul style="list-style-type: none"> equipment designed to protective class II shall not have means of connection for the external protective earthing conductor. However this does not apply if the external protective earthing conductor is passed through the equipment to equipment series-connected beyond it. In the latter event, the external protective earthing conductor and its means for connection shall be insulated with basic insulation from the accessible surface of the equipment and from circuits that employ protective separation, extra-low voltage, protective impedance and limited discharging energy, according to 7.3.5. This basic insulation shall correspond to the rated voltage of the series-connected equipment; 		P
	<ul style="list-style-type: none"> metal-encased equipment of protective class II may have provision on its enclosure for the connection of an equipotential bonding conductor; 		N/A
	<ul style="list-style-type: none"> equipment of protective class II may have provision for the connection of an earthing conductor for functional reasons or for damping of overvoltages; it shall, however, be insulated as though it is a live part; 		N/A
	<ul style="list-style-type: none"> equipment employing protective class II shall be marked according to 5.1.8. 		N/A
7.3.7	Insulation Including Clearance and Creepage Distance		P
7.3.7.1	General	See below	P
	This subclause gives minimum requirements for insulation, based on the principles of IEC 60664.	Considered	P
	Manufacturing tolerances shall be taken into account during measurement of creepage, clearance, and insulation distance in the PCE.	Considered	P
	Insulation shall be selected after consideration of the following influences:	Considered	P
	<ul style="list-style-type: none"> pollution degree 	PD2 for internal environment, PD3 for external environment.	P
	<ul style="list-style-type: none"> overvoltage category 	The mains circuits: OVC III The PV Array circuits: OVC II	P
	<ul style="list-style-type: none"> supply earthing system 	TN, system	P
	<ul style="list-style-type: none"> insulation voltage 	Considered	P
	<ul style="list-style-type: none"> location of insulation 	Considered	P
	<ul style="list-style-type: none"> type of insulation 	Considered	P



IEC/EN 62109-1, IEC/EN 62109-2			
Clause	Requirement – Test	Result – Remark	Verdict
	Compliance of insulation, creepage distances, and clearance distances, shall be verified by measurement or visual inspection, and the tests of 7.5.	Considered	P
7.3.7.1.1	Pollution degree		P
	Insulation, especially when provided by clearances and creepage distances, is affected by pollution that occurs during the expected lifetime of the PCE. The pollution degree rating of the PCE or section of the PCE to be used in judging the requirements of this section shall be the pollution degree determined according to 6.1 and 6.2.	PD2 for internal environment, PD3 for external environment.	P
7.3.7.1.2	Overvoltage category and Impulse withstand voltage rating		P
	The concept of overvoltage categories is applied to each separate circuit in the PCE, including mains circuits, PV circuits, and other circuits, whether connected to or isolated from the mains and PV circuits, as follows:		P
	a) For equipment or circuits energized from the mains, four categories are considered:		P
	<ul style="list-style-type: none"> category IV applies to equipment permanently connected at the origin of an installation (upstream of the main distribution board). Examples are electricity meters, primary overcurrent protection equipment and other equipment connected directly to outdoor open lines 		N/A
	<ul style="list-style-type: none"> category III applies to fixed equipment downstream of, and including, the main distribution board. Examples are switchgear and other equipment in an industrial installation; 		P
	<ul style="list-style-type: none"> category II applies to equipment not permanently connected to the installation. Examples are appliances, portable tools and other plug-connected equipment; 		N/A
	<ul style="list-style-type: none"> category I applies to equipment connected to a circuit where measures have been taken to reduce transient overvoltages to a low level. 		N/A
	Impulse withstand voltage ratings for the mains circuit are assigned based on the above OVC and on the mains system voltage, as in 7.3.7.1.4.	See clause 7.3.7.1.4.	P
	b) For PV circuits in general, Overvoltage Category II is assumed, and impulse withstand voltage ratings for the PV circuit are assigned based on the PV system voltage as in 7.3.7.1.4, but the minimum impulse voltage to be used is 2 500 V.	See clause 7.3.7.1.4.	P



IEC/EN 62109-1, IEC/EN 62109-2			
Clause	Requirement – Test	Result – Remark	Verdict
	c) For PCE with galvanic isolation between the mains and PV circuits, the impulse voltage withstand ratings of the mains and PV circuits are determined as in a) and b) above, and then the effect of reduction of OVC across the isolation is evaluated as follows:	No-isolation inverter.	N/A
	– The magnitude of impulses from the mains circuit on the PV circuit is determined by reducing the OVC of the mains circuit by one level, and determining the resulting impulse voltage withstand rating based on mains system voltage.		N/A
	– The rating to be used on the PV circuit is the higher of the value in b) and the value calculated above.		N/A
	– The magnitude of impulses from the PV circuit on the mains circuit is determined by reducing the OVC of the PV circuit by one level, and determining the resulting impulse voltage withstand rating based on PV system voltage.		N/A
	– The rating to be used on the mains circuit is the higher of the value in a) and the value calculated above.		N/A
	d) For PCE not providing galvanic isolation between the mains and PV circuits, the impulse withstand voltage ratings of the mains and PV circuits are determined as in a) and b) above, and the higher of the two impulse withstand voltage ratings is used for the entire combined circuit. For circuits connected to the combined circuit without galvanic isolation, the impulse withstand voltage rating of the combined circuit applies.	The higher impulse withstand voltage ratings between the mains circuits and PV circuits were used for the entire combined circuit.	P
	e) For other circuits the impulse withstand voltage rating is the most severe rating determined by the relationship of the circuit under consideration to the PV and mains circuits, according to the following:	Considered.	P
	• for circuits connected to the mains without galvanic isolation, the impulse withstand voltage rating of the mains circuit applies;		P
	• for circuits connected to the PV circuit without galvanic isolation, the impulse withstand voltage rating of the PV circuit applies;		P



IEC/EN 62109-1, IEC/EN 62109-2			
Clause	Requirement – Test	Result – Remark	Verdict
	<ul style="list-style-type: none"> where isolation is provided by means of isolation transformers, optocouplers, or similar galvanic isolation devices, between a considered circuit and an adjacent mains or PV circuit, the impulse withstand voltage rating of the considered circuit is reduced by one level from that of the adjacent circuit; if more than one adjacent circuit is involved, the highest resulting impulse withstand voltage rating applies. 		P
	f) The overvoltage categories determined as above apply from circuits to earth. The overvoltage category that applies to functional insulation within each circuit is one category lower (less severe) than the overvoltage category that applies from the circuit to earth.	Considered	P
	g) Application of means to reduce impulse voltages: For basic and functional insulation, if transient reduction means are provided which reduce impulses to lower values, insulation may be designed for the reduced impulse levels. The reduced values to be used are the highest impulses occurring in the testing of 7.5.1.	No such parts.	N/A
	If such devices are used to reduce the values for design of Basic insulation, and the devices can be damaged by overvoltages or repeated impulses, thus decreasing their ability to reduce impulses, they shall be monitored and an indication of their status provided.		N/A
7.3.7.1.3	Supply earthing systems		P
	Three basic types of earthing system are described in IEC 60364-1. They are:	Considered	P
	<ul style="list-style-type: none"> TN system: has one point directly earthed, the accessible conductive parts of the installation being connected to that point by protective conductors. Three types of TN systems, TN-C, TN-S and TN-C-S, are defined according to the arrangement of the neutral and protective conductor. 	Considered	P
	<ul style="list-style-type: none"> TT system: has one point directly earthed, the accessible conductive parts of the installation being connected to earth electrodes electrically independent of the earth electrodes of the power system; 	Considered	P
	<ul style="list-style-type: none"> IT system: has all live parts isolated from earth or one point connected to earth through an impedance, the accessible conductive parts of the installation being earthed independently or collectively to the earthing system. 	Considered	P
7.3.7.1.4	Insulation voltages		P



IEC/EN 62109-1, IEC/EN 62109-2			
Clause	Requirement – Test	Result – Remark	Verdict
	Table 12 makes use of the circuit system voltage and overvoltage category to define the impulse withstand voltage and the temporary overvoltage.	Considered	P
7.3.7.2	Insulation between a circuit and its surroundings	Considered	P
7.3.7.2.1	Basic, supplementary, and reinforced insulation between a circuit and its surroundings shall be designed according to: the impulse voltage; or the temporary overvoltage; or the working voltage of the circuit. System voltage in column 1 is:	Considered	P
	• in TN and TT systems: the r.m.s. value of the rated voltage between a phase and earth;		P
	• in three-phase IT systems:	Considered	P
	– for determination of impulse voltage, the r.m.s. value of the rated voltage between a phase and an artificial neutral point (an imaginary junction of equal impedances from each phase);	Considered	P
	– for determination of temporary overvoltage, the r.m.s. value of the rated voltage between phases;	Considered	P
	• In single-phase IT systems: the r.m.s. value of the rated voltage between phase conductors.	The inverter is a three-phase type.	N/A
7.3.7.2.2	Clearances and solid insulation between circuits connected directly to the mains and their surroundings shall be designed according to the impulse voltage, temporary overvoltage, or working voltage, whichever gives the most severe requirement.	Considered	P
7.3.7.2.3	Circuits other than mains circuits		P
	Clearances and solid insulation between circuits other than the mains and their surroundings shall be designed according to impulse voltage and recurring peak voltage, according to the following:		P
	– the system voltage is – for PV circuits, the max rated PV open circuit voltage; – for other circuits, the working voltage;		P
	– the impulse voltage is determined from Table 12, using the system voltage above and according to 7.3.7.1.2;		P
	– the working voltage or the impulse voltage, whichever gives the more severe requirement, determines the design of the clearances and solid insulation.		P
7.3.7.2.4	Insulation between two circuits shall be designed according to the following: a) for clearances and insulation, the requirements are determined by the circuit having the higher impulse voltages; b) for creepages, r.m.s. working voltage across the insulation determines the requirements.		P



IEC/EN 62109-1, IEC/EN 62109-2			
Clause	Requirement – Test	Result – Remark	Verdict
7.3.7.3	Functional insulation is permitted, the voltage used for insulation requirements is determined.		P
7.3.7.4	Clearance distances		P
7.3.7.4.1	Table 13 defines the minimum clearance distances required to provide functional, basic, or supplementary insulation.	Considered	P
	To determine clearances for reinforced insulation from Table 13, the value corresponding to the next higher impulse voltage, or 1,6 times the temporary overvoltage, or 1,6 times the working voltage shall be used, whichever results in the most severe requirement.	See appended table 7.3.7	P
7.3.7.4.2	Electric field homogeneity	Considered	P
	Homogeneous electric field distribution within impulse voltage is equal to or greater than 6000V circuits.		P
7.3.7.4.3	Clearance to conductive enclosures		P
	The clearance between any non-insulated live part and the walls of a metal enclosure shall be in accordance with 7.3.7.4.1 following the deformation tests of 13.7.	Considered	P
	If the design clearance is at least 12,7 mm and the clearance required by 7.3.7.4.1 does not exceed 8 mm, the deformation tests may be omitted.	See clause 13.7.2	P
7.3.7.5	Creepage distances		P
7.3.7.5.1	General	See below.	P
	Creepage distances shall be verified by measurement or inspection, according to Table 14. For reinforced insulation, the distances in Table 14 shall be doubled.	Considered	P
7.3.7.5.2	Voltage		P
	Table 14 is the r.m.s. value of the working voltage across the creepage distance. Interpolation is permitted.	See appended Table 7.3.7	P
7.3.7.5.3	Materials		P
	Insulating materials are classified into four groups corresponding to their comparative tracking index (CTI) when tested according to 6.2 of IEC 60112 <ul style="list-style-type: none"> • Insulating material group I CTI ≥ 600; • Insulating material group II 600 CTI ≥ 400; • Insulating material group IIIa 400 CTI ≥ 175; • Insulating material group IIIb 175 CTI ≥ 100. Creepage distances on printed wiring boards (PWBs) exposed to pollution degree 3 environmental conditions shall be determined based on Table 14 Pollution degree 3 under “Other insulators”.	Considered	P



IEC/EN 62109-1, IEC/EN 62109-2			
Clause	Requirement – Test	Result – Remark	Verdict
	If the creepage distance is ribbed, then the creepage distance of insulating material of group I may be applied when using insulating material of group II and the creepage distance of insulating material of group II may be applied when using insulating material of group III.		N/A
	Except at pollution degree 1 the ribs shall be 2 mm high at least. The spacing of the ribs shall equal or exceed the dimension 'X' in Annex A Table A.1.	Considered	P
	For inorganic insulating materials, for example glass or ceramic, which do not track, the creepage distance may equal the associated clearance, as determined from Table 13.	Considered	P
7.3.7.6	Coating	No such parts.	N/A
	A coating may be used to provide insulation, to protect a surface against pollution, and to allow a reduction in creepage and clearance distances		N/A
7.3.7.7	PWB spacings for functional insulation		P
	Functional insulation on a PWB which do not comply with 7.3.7.4 and 7.3.7.5 are permitted when all the following: <ul style="list-style-type: none"> the PWB has flammability rating of V-0 (see IEC 60695-11-10); and the PWB base material has a minimum CTI of 175; and the equipment complies with the PWB short-circuit test (see 4.4.4.14). Working voltages less than 80 V (r.m.s.) or 110 V (recurring peak) are covered with a suitable coating. The coating is not required to be tested.	Considered	P
7.3.7.8	Solid insulation		P
7.3.7.8.1	General	See below	P
	Materials selected for solid insulation shall be able to withstand the stresses occurring in the application. These include mechanical, electrical, thermal and climatic stresses which are to be expected in normal use. Insulation materials shall also be resistant to ageing during the expected lifetime of the PCE.	Considered	P
	Tests shall be performed on components and subassemblies using solid insulation, in order to ensure that the insulation performance has not been compromised by the design or manufacturing process.	Considered	P
	Components that comply with a relevant component standard that provide equivalent requirements to those of this standard do not require separate evaluation. Assemblies containing such components shall be tested according to the requirements of this standard.	Considered	P
7.3.7.8.2	Requirements for electrical withstand capability of solid insulation		P
7.3.7.8.2.1	Basic, supplemental, reinforced, and double insulation	See below	P



IEC/EN 62109-1, IEC/EN 62109-2			
Clause	Requirement – Test	Result – Remark	Verdict
	Solid insulation shall withstand the applicable impulse withstand voltage test according to 7.5.1 and the a.c. or d.c. voltage test according to 7.5.2. In addition, double and reinforced insulation shall withstand the partial discharge test according to 7.5.3, if the recurring peak working voltage across the insulation is greater than 700 V and the voltage stress on the insulation is greater than 1 kV/mm.	See clause 7.5.1, 7.5.2 and 7.5.3.	P
7.3.7.8.2.2	Functional insulation		P
	Functional insulation shall comply with the requirements of 7.3.7.3. Testing is not required.	Considered	P
7.3.7.8.3	Thin sheet or tape material		P
7.3.7.8.3.1	General		P
	Insulation consisting of thin (less than 0,7 mm) sheet or tape materials is permitted, provided that it is protected from damage and is not subject to mechanical stress under normal use.	The transformer primary and secondary windings were separated by thin insulation sheet.	P
	Thin sheet or tape material shall comply with the requirements for solid insulation in 7.3.7.8.1 and with 7.3.7.8.3.2 or 7.3.7.8.3.3 as applicable.		P
7.3.7.8.3.2	Material thickness not less than 0,2 mm		P
	<ul style="list-style-type: none"> Basic or supplementary insulation shall consist of at least one layer of material, and shall meet the impulse and a.c. or d.c. voltage test requirements of 7.3.7.8.2.1 for basic or supplementary insulation. 		P
	<ul style="list-style-type: none"> Double insulation shall consist of at least two layers of material. Each layer shall meet the impulse and a.c. or d.c. voltage test requirements of 7.3.7.8.2.1 for basic insulation, and the partial discharge requirements of 7.3.7.8.2.1. The two or more layers together shall meet the impulse and a.c. or d.c. voltage test requirements of 7.3.7.8.2.1 for double insulation. 		P
	<ul style="list-style-type: none"> Reinforced insulation shall consist of a single layer of material, which will meet the impulse, a.c. or d.c. voltage, and partial discharge test requirements 7.3.7.8.2.1 for reinforced insulation. 		P
7.3.7.8.3.3	Material thickness less than 0,2 mm		P
	<ul style="list-style-type: none"> Basic or supplementary insulation shall consist of at least one layer of material, and shall meet the impulse and a.c. or d.c. voltage test requirements of 7.3.7.8.2.1 for basic or supplementary insulation. 		P
	<ul style="list-style-type: none"> Double insulation shall consist of at least three layers of material. Each layer shall meet the impulse and a.c. or d.c. voltage test requirements of 7.3.7.8.2.1 for basic insulation Any two layers together shall meet the impulse, a.c. or d.c. voltage, and partial discharge test requirements of 7.3.7.8.2.1 for double insulation. 		P



IEC/EN 62109-1, IEC/EN 62109-2			
Clause	Requirement – Test	Result – Remark	Verdict
	<ul style="list-style-type: none"> Reinforced insulation consisting of a single layer of material less than 0,2 mm thick is not permitted. 		P
7.3.7.8.3.4	Compliance		P
	Compliance is checked by the tests described in 7.5.1 to 7.5.3 applied according to 7.3.7.8.2. When a component or sub-assembly makes use of thin sheet insulating materials, it is permitted to perform the tests on the component rather than on the material.	See clause 7.5.1, 7.5.2 and 7.5.3.	P
7.3.7.8.4	Printed wiring boards (PWBs)	Considered.	P
7.3.7.8.4.1	General		P
	Insulation between conductor layers in PWBs, shall meet the requirements for solid insulation in 7.3.7.8. For the inner layers of multi-layer PWBs, the insulation between adjacent tracks on the same layer shall be treated as either:		P
	<ul style="list-style-type: none"> a creepage distance for pollution degree 1 and a clearance as in air (see Annex A, figure A.13); or 		P
	<ul style="list-style-type: none"> as solid insulation, in which case it shall meet the requirements of 7.3.7.8. 		P
7.3.7.8.4.2	Use of coating materials	No coating materials.	N/A
	A coating material used to provide a microenvironment or to provide functional, basic, supplementary and reinforced insulation shall meet the requirement as specified below.		N/A
	<ul style="list-style-type: none"> Type 1 protection improves the microenvironment (PollutionDegree) of the parts under protection. The clearance and creepage distance of Table 13 and Table 14 for pollution degree 1 apply under the protection. 		N/A
	<ul style="list-style-type: none"> Type 2 protection is considered to be similar to solid insulation. Under the protection, the requirements for solid insulation specified in 7.3.7.8 are applicable and spacings shall not be less than those specified in Table 1 of IEC 60664-3. 		N/A
	The coating material used to provide Type 1 and Type 2 protection shall be check by a type test on representative PWB's, conducted according to IEC 60664-3 Clause 5.		N/A
7.3.7.8.5	Wound components		P
	Varnish or enamel insulation of wires shall not be used for basic, supplementary, double or reinforced insulation.	Considered.	P
	The component itself shall pass the requirements given in 7.3.7.8.1 and 7.3.7.8.2. If the component has reinforced or double insulation, the voltage test in 7.5.2 shall be performed as a routine test.	Considered.	P
7.3.7.8.6	Potting materials		N/A



IEC/EN 62109-1, IEC/EN 62109-2			
Clause	Requirement – Test	Result – Remark	Verdict
	A potting material may be used to provide solid insulation or to act as a coating to protect against pollution. it shall comply with the requirements of 7.3.7.8.1 and 7.3.7.8.2. or the requirements for Type 1 protection in 7.3.7.8.4.2 apply.		N/A
7.3.7.9	Insulation requirements above 30 kHz	Considered.	P
7.3.8	Residual Current-operated protective (RCD) or monitoring (RCM) device compatibility	The RCD is built-in type within the PCE.	P
	RCD and RCM are used to provide protection against insulation faults in some domestic and industrial installations, additional to that provided by the installed equipment.		P
7.3.9	Capacitor discharge	See below.	P
7.3.9.1	Operator access area		P
	Equipment shall be so designed that there is no risk of electric shock in operator access areas from charge stored on capacitors after disconnection of the PCE.	The operator is instructed to the installation shall be performed by qualified technician. The pins of connector cannot be touched by test finger due to the design protection.	P
7.3.9.2	Service access areas		P
	Capacitors located behind panels that are removable for servicing, installation, or disconnection shall present no risk of electric shock or energy hazard from charge stored on capacitors after disconnection of the PCE.	The symbol 21 of Annex C with 5min was provided on the label.	P
7.3.10 of IEC 62109-2	Additional requirements for stand-alone inverters		P
	Depending on the supply earthing system that a stand-alone inverter is intended to be used with or to create, the output circuit may be required to have one circuit conductor bonded to earth to create a grounded conductor and an earthed system.		P
	The means used to bond the grounded conductor to protective earth may be provided within the inverter or as part of the installation. If not provided integral to the inverter, the required means shall be described in the installation instructions as per 5.3.2.8.	External isolated transformer provided Neutral bonded to earthing and installed on field, which required in user manual	P
	The means used to bond the grounded conductor to protective earth shall comply with the requirements for protective bonding in Part 1, except that if the bond can only ever carry fault currents in stand-alone mode, the maximum current for the bond is determined by the inverter maximum output fault current.		P
	Output circuit bonding arrangements shall ensure that in any mode of operation, the system only has the grounded circuit conductor bonded to earth in one place at a time. Switching arrangements may be used, in which case the switching device used is to be subjected to the bond impedance test along with the rest of the bonding path.		N/A



IEC/EN 62109-1, IEC/EN 62109-2			
Clause	Requirement – Test	Result – Remark	Verdict
	Inverters intended to have a circuit conductor bonded to earth shall not impose any normal current on the bond except for leakage current.		P
	Outputs that are intentionally floating with no circuit conductor bonded to ground, must not have any voltages with respect to ground that are a shock hazard in accordance with Clause 7 of Parts 1 and 2. The documentation for the inverter shall indicate that the output is floating as per 5.3.2.8.		N/A
7.3.11 of IEC 62109-2	Functionally grounded arrays	No such parts.	N/A
	All PV conductors in a functionally grounded array shall be treated as being live parts with respect to protection against electric shock.		N/A
7.4	Protection against energy hazards		P
7.4.1	Determination of hazardous energy level		P
	A hazardous energy level is considered to exist if	See below	P
	a) The voltage is 2 V or more, and power available after 60 s exceeds 240 VA.	Considered	P
	b) The stored energy in a capacitor is at a voltage. U of 2 V or more, and the stored energy. E, calculated from the following equation, exceeds 20J: $E = 0,5 CU^2$	Considered	P
7.4.2	Operator Access Areas	See below	P
	Equipment shall be so designed that there is no risk of energy hazard in operator access areas from accessible circuits.	All hazardous energy parts were enclosed within earthed metal enclosure.	P
7.4.3	Services Access Areas		P
	Energy storage devices located behind panels that are removable for servicing, installation or disconnection shall present no risk of electric energy hazard from charge stored after disconnection of the PCE.	See below	P
	Energy storage devices within a PCE shall be discharged to an energy level less than 20 J, as in 7.4.1, within 10 s after the removal	The symbol 21 of Annex C was provided on the label.	P
7.5	Electrical test related to shock hazard		P
7.5.1	Impulse voltage test (type test)		P
	The impulse voltage test is performed with voltage having a 1.2/50µs waveform. Test is performed using the impulse withstand voltage listed in Table 16.	See below	P
	The impulse voltage test and is successfully passed if no puncture, flashover, or sparkover occurs.	See appended Table 7.5	P
7.5.2	Dielectric strength test		P
7.5.2.2	The values of the test voltage are determined from column 2 or 3 of Table 17 or Table 18.	See below	P



IEC/EN 62109-1, IEC/EN 62109-2			
Clause	Requirement – Test	Result – Remark	Verdict
	The voltage test shall be performed with a sinusoidal voltage at 50 Hz or 60 Hz. If the circuit contains capacitors the test may be performed with a d.c. voltage of a value equal to the peak value of the specified a.c. voltage.	See appended Table 7.5	P
7.5.2.3	Humidity pre-conditioning		P
	For type tests on PCE for which wet locations requirements apply, according to 6.1, the humidity pre-conditioning of 4.5 shall be performed immediately prior to the voltage test.	Considered	P
7.5.2.4	Performing the voltage test.		P
	a) between accessible conductive part and each circuit sequentially.	Considered	P
	b) Test between each considered circuit sequentially and the other adjacent circuits connected together.	Considered	P
	c) Test between DVC A circuit and each adjacent circuit sequentially	Considered	P
	The tests shall be performed with the PCE fully assembled, and all covers in place and all doors of the enclosure closed.		P
	Wherever practicable, individual components forming part of the insulation under test, for example interference suppression capacitors, should not be disconnected or bridged before the test.		P
	Where the PCE is covered totally or partly by a non-conductive accessible surface, a conductive foil to which the test voltage is applied shall be wrapped around this surface for testing.		P
7.5.2.5	Duration of the a.c. or d.c. voltage test		P
	The duration of the test shall be at least 60 s at full voltage for the type test and 1 s for the routine test.	Considered	P
7.5.2.6	Verification of the a.c. or d.c. voltage test		P
	The test is successfully passed if no electrical breakdown occurs and there is no abnormal current flow during the test.	Considered	P
7.5.3	Partial discharge test		N/A
	the partial discharge test shall confirm that the solid insulation used within devices applied for protective separation of electrical circuits remains partialdischarge- free within the specified voltage range (see Table 19).		N/A
7.5.4	Touch current measurement (type test)		P
	The touch current shall be measured if required by 7.3.6.3.7 and shall not be greater than 3.5 mA a.c. or 10 mA d.c. or special measures of protection as given in 7.3.6.3.7 are required.	See 7.3.6.3.7	P
	For type tests on PCE for which wet locations requirements apply according to 6.1, the humidity pre-conditioning of 4.5 shall be performed immediately prior to the touch current test.	See 7.3.6.3.7	P
7.5.5	Equipment with multiple sources of supply		N/A



IEC/EN 62109-1, IEC/EN 62109-2			
Clause	Requirement – Test	Result – Remark	Verdict
	Hazards, within the meaning of this standard, shall not be present under normal or single fault conditions due to the presence of multiple sources of supply. Information shall be provided with the equipment indicating the presence of multiple sources of supply and giving disconnection procedures.		N/A
8	PROTECTION AGAINST MECHANICAL HAZARDS		P
8.1	General		P
	Operation shall not lead to a mechanical HAZARD in NORMAL CONDITION or SINGLE FAULT CONDITION. Edges, projections, corners, openings, guards, handles and the like, that are accessible to the operator shall be smooth and rounded so as not to cause injury during normal use of the equipment.	No mechanical hazards under the normal or single fault condition.	P
	Conformity is checked as specified in 8.2 to 8.6.		P
8.2	Moving parts		P
	Moving parts shall not be able to crush, cut or pierce parts of the body of an OPERATOR likely to contact them, nor severely pinch the OPERATOR's skin. Hazardous moving parts of equipment, that is moving parts which have the potential to cause injury, shall be so arranged, enclosed or guarded as to provide adequate protection against the risk of personal injury.	Considered.	P
8.2.1	Protection of service persons	No mechanical hazards for service persons.	P
	Protection shall be provided such that unintentional contact with hazardous moving parts is unlikely during servicing operations. If a guard over a hazardous moving part may need to be removed for servicing, the marking of symbol 15 of Table D-1 shall be applied on or near the guard.		P
8.3	Stability		N/A
	Equipment and assemblies of equipment not secured to the building structure before operation shall be physically stable in NORMAL USE.	PCE for wall mounting.	N/A
8.4	Provisions for lifting and carrying		N/A
	If carrying handles or grips are fitted to, or supplied with, the equipment, they shall be capable of withstanding a force of four times the weight of the equipment.		N/A
	Equipment or parts having a mass of 18 kg or more shall be provided with a means for lifting and carrying or directions shall be given in the manufacturer's documentation.		N/A
8.5	Wall mounting		P
	Mounting brackets on equipment intended to be mounted on a wall or ceiling shall withstand a force of four times the weight of the equipment.	No any damaged after testing.	P
8.6	Expelled parts		N/A



IEC/EN 62109-1, IEC/EN 62109-2			
Clause	Requirement – Test	Result – Remark	Verdict
	Equipment shall contain or limit the energy of parts that could cause a HAZARD if expelled in the event of a fault.	No such parts.	N/A

9 PROTECTION AGAINST FIRE HAZARDS			P
9.1	Resistance to fire		P
	This subclause specifies requirements intended to reduce the risk of ignition and the spread of flame, both within the equipment and to the outside, by the appropriate use of materials and components and by suitable construction.	PCE employed with metal enclosure reduce the risk of ignition and the spread of flame.	P
9.1.1	Reducing the risk of ignition and spread of flame		P
	For equipment or a portion of equipment, there are two alternative methods of providing protection against ignition and spread of flame that could affect materials, wiring, wound components and electronic components such as integrated circuits, transistors, thyristors, diodes, resistors and capacitors.	Method 1 is used.	P
9.1.2	Conditions for a fire enclosure		P
	A FIRE ENCLOSURE is required for equipment or parts of equipment for which Method 2 is not fully applied and complied with.	Fire enclosure is used.	P
9.1.2.1	Parts requiring a fire enclosure		P
	Except where Method 2 is used, or as permitted in 9.1.2.2, the following are considered to have a risk of ignition and, therefore, require a FIRE ENCLOSURE:	Considered.	P
	– components in PRIMARY CIRCUITS	Considered.	P
	– components in SECONDARY CIRCUITS supplied by power sources which exceed the limits for a LIMITED POWER SOURCE as specified in 9.2;	Considered.	P
	– components in SECONDARY CIRCUITS supplied by a LIMITED POWER SOURCE as specified in 9.2, but not mounted on a material of FLAMMABILITY CLASS V-1;	No such devices.	N/A
	– components within a power supply unit or assembly having a limited power output complying with the criteria for a LIMITED POWER SOURCE as specified in 9.2, including overcurrent protective devices, limiting impedances, regulating networks and wiring, up to the point where the LIMITED POWER SOURCE output criteria are met;	No such devices.	N/A
	– components having unenclosed arcing parts, such as open switch and relay contacts and commutators, in a circuit at HAZARDOUS VOLTAGE or at a HAZARDOUS ENERGY LEVEL; and	No such devices.	N/A
	– insulated wiring, except as permitted in 9.1.2.2.	Considered.	P



IEC/EN 62109-1, IEC/EN 62109-2			
Clause	Requirement – Test	Result – Remark	Verdict
9.1.2.2	Parts not requiring a fire enclosure	Component within fire enclosure.	N/A
9.1.3	Materials requirements for protection against fire hazard		P
9.1.3.1	General		P
	ENCLOSURES, components and other parts shall be so constructed, or shall make use of such materials, that the propagation of fire is limited.	Considered.	P
9.1.3.2	Materials for fire enclosures		P
	If an enclosure material is not classified as specified below, a test may be performed on the final enclosure or part of the enclosure, in which case the material shall additionally be subjected to periodic SAMPLE testing.	PCE with metal fire enclosure.	P
9.1.3.3	Materials for components and other parts outside fire enclosures	Considered.	P
	Except as otherwise noted below, materials for components and other parts (including MECHANICAL ENCLOSURES, ELECTRICAL ENCLOSURES and DECORATIVE PARTS); located outside FIRE ENCLOSURES, shall be of FLAMMABILITY CLASS HB.	Considered.	P
9.1.3.4	Materials for air filter assemblies		N/A
9.1.4	Openings in fire enclosures	No such opening	N/A
9.1.4.1	General		N/A
	For equipment that is intended to be used or installed in more than one orientation as specified in the product documentation, the following requirements apply in each orientation.	Vertical mounting only.	N/A
	These requirements are in addition to those in the following sections:		N/A
	– 7.3.4, Protection against direct contact;		N/A
	– 7.4, Protection against energy hazards;		N/A
	– 13.5, Openings in enclosures		N/A
9.1.4.2	Side openings treated as bottom openings		N/A
9.1.4.3	Openings in the bottom of a fire enclosure	PCE for use in a closure electrical operating area.	N/A
	The bottom of a FIRE ENCLOSURE or individual barriers, shall provide protection against emission of flaming or molten material under all internal parts, including partially enclosed components or assemblies, for which Method 2 of 9.1.1 has not been fully applied and complied with.	PCE for use in a closure electrical operating area.	N/A
9.1.4.4	Equipment for use in a CLOSED ELECTRICAL OPERATING AREA	Considered.	P
	The requirements of 9.1.4.3 do not apply to FIXED EQUIPMENT intended only for use in a CLOSED ELECTRICAL OPERATING AREA and to be mounted on a concrete floor or other non-combustible surface. Such equipment shall be marked as follows:	Considered.	P



IEC/EN 62109-1, IEC/EN 62109-2			
Clause	Requirement – Test	Result – Remark	Verdict
	WARNING: FIRE HAZARD SUITABLE FOR MOUNTING ON CONCRETE OR OTHER NON-COMBUSTIBLE SURFACE ONLY	Considered.	P
9.1.4.5	Doors or covers in fire enclosures	No any door or covers in fire enclosure.	N/A
9.1.4.6	Additional requirements for openings in transportable equipment		N/A
9.2	LIMITED POWER SOURCES	No LPS circuits.	N/A
9.2.1	General		N/A
9.2.2	Limited power source tests		N/A
9.3	Short-circuit and overcurrent protection		P
9.3.1	General		P
	The PCE shall not present a hazard, under short-circuit or overcurrent conditions at any port, including phase-to-phase, phase-to-earth and phase-to-neutral, and adequate information shall be provided to allow proper selection of external wiring and external protective devices.	The circumstances of short-circuit and overcurrent are protected by the circuits design. When short-circuit or overcurrent of components occurred, the PCE will shutdown and disconnect from the grid immediately.	P
9.3.2	Protection against short-circuits and overcurrents shall be provided for all input circuits, and for output circuits that do not comply with the requirements for limited power sources in 9.2, except for circuits in which no overcurrent hazard is presented by short-circuits and overloads.		N/A
9.3.3	Protective devices provided or specified shall have adequate breaking capacity to interrupt the maximum short circuit current specified for the port to which they are connected. If protection that is provided integral to the PCE for an input port is not rated for the short-circuit current of the circuit in which it is used, the installation instructions shall specify that an upstream protective device, rated for the prospective short-circuit current of that port, shall be used to provide backup protection.		N/A
9.3.4 of IEC 62109-2	Inverter backfeed current onto the array	Considered.	P
	The backfeed current testing and documentation requirements in Part 1 apply, including but not limited to the following.	Considered.	P
	Testing shall be performed to determine the current that can flow out of the inverter PV input terminals with a fault applied on inverter or on the PV input wiring. Faults to be considered include shorting all or part of the array, and any faults in the inverter that would allow energy from another source (for example the mains or a battery) to impress currents on the PV array wiring. The current measurement is not required to include any current transients that result from applying the short circuit, if such transients result from discharging storage elements other than batteries.	No backfeed current that can flow out of the inverter PV input terminals.	P



IEC/EN 62109-1, IEC/EN 62109-2			
Clause	Requirement – Test	Result – Remark	Verdict
	This inverter backfeed current value shall be provided in the installation instructions regardless of the value of the current, in accordance with Table 33.		N/A
10	PROTECTION AGAINST SONIC PRESSURE HAZARDS		P
10.1	General		P
	The equipment shall provide protection against the effect of sonic pressure. Conformity tests are carried out if the equipment is likely to cause such HAZARDS.	No sonic pressure hazards.	P
10.2	Sonic pressure and Sound level		P
10.2.1	Hazardous Noise Levels		P
11	PROTECTION AGAINST LIQUID HAZARDS		N/A
11.1	Liquid Containment, Pressure and Leakage	No liquid containment.	N/A
	The liquid containment system components shall be compatible with the liquid to be used.		N/A
	There shall be no leakage of liquid onto live parts as a result of:		N/A
	a) Normal operation, including condensation;		N/A
	b) Servicing of the equipment; or		N/A
	c) Inadvertent loosening or detachment of hoses or other cooling system parts over time.		N/A
11.2	Fluid pressure and leakage		N/A
11.2.1	Maximum pressure		N/A
11.2.2	Leakage from parts		N/A
11.2.3	Overpressure safety device		N/A
11.3	Oil and grease		N/A
12	CHEMICAL HAZARDS		N/A
12.1	General	No chemical hazards.	N/A
13	PHYSICAL REQUIREMENTS		P
13.1	Handles and manual controls		P
	Handles, knobs, grips, levers and the like shall be reliably fixed so that they will not work loose in normal use, if this might result in a hazard. Sealing compounds and the like, other than selfhardening resins, shall not be used to prevent loosening. If handles, knobs and the like are used to indicate the position of switches or similar components, it shall not be possible to fix them in a wrong position if this might result in hazard.	DC breaker holder for manual controls.	P
13.1.1	Adjustable controls	No such devices.	N/A
13.2	Securing of parts		P
13.3	Provisions for external connections		P
13.3.1	General		P
13.3.2	Connection to an a.c. Mains supply	AC connector to an a.c. mains supply.	P
13.3.2.1	General		P



IEC/EN 62109-1, IEC/EN 62109-2			
Clause	Requirement – Test	Result – Remark	Verdict
	For safe and reliable connection to a MAINS supply, equipment shall be provided with one of the following:		P
	– terminals or leads or a non-detachable power supply cord for permanent connection to the supply; or	Screw terminal for permanent connection to the supply.	P
	– a non-detachable power supply cord for connection to the supply by means of a plug		N/A
	– an appliance inlet for connection of a detachable power supply cord; or		N/A
	– a mains plug that is part of direct plug-in equipment as in 13.3.8		N/A
13.3.2.2	Permanently connected equipment	Specific and certified connectors used.	P
13.3.2.3	Appliance inlets		N/A
13.3.2.4	Power supply cord	No supply cord.	N/A
13.3.2.5	Cord anchorages and strain relief		N/A
	For equipment with a non-detachable power supply cord, a cord anchorage shall be supplied such that:		N/A
	– the connecting points of the cord conductors are relieved from strain; and	No supply cord.	N/A
	– the outer covering of the cord is protected from abrasion.	No supply cord.	N/A
13.3.2.6	Protection against mechanical damage		P
13.3.3	Wiring terminals for connection of external conductors	DC and AC terminals for connection of external conductors.	P
13.3.3.1	Wiring terminals		P
13.3.3.2	Screw terminals		P
13.3.3.3	Wiring terminal sizes		P
13.3.3.4	Wiring terminal design		P
13.3.3.5	Grouping of wiring terminals		P
13.3.3.6	Stranded wire		P
13.3.4	Supply wiring space		P
13.3.5	Wire bending space for wires 10 mm ² and greater		P
13.3.6	Disconnection from supply sources	The explanations are provided in the installation manual.	P
13.3.7	Connectors, plugs and sockets	The misconnection is unlikely for PVDC connectors and AC output connector.	P
13.3.8	Direct plug-in equipment	Permanently equipment.	N/A
13.4	Internal wiring and connections		P
13.4.1	General	All wires were used suitably and are fixed well to prevent mechanical damage during installation.	P
13.4.2	Routing	The wires were routed away from all parts which could abrade the insulation of wires.	P



IEC/EN 62109-1, IEC/EN 62109-2			
Clause	Requirement – Test	Result – Remark	Verdict
13.4.3	Colour coding	Green/yellow wire only used for protective earthing conductor.	P
13.4.4	Splices and connections	Quick connectors were used for internal connection.	P
13.4.5	Interconnections between parts of the PCE	The communication cable only used for servicing, no any physical damage or mechanical damage likely.	P
13.5	Openings in enclosures	No such opening	N/A
13.5.1	Top and side openings	See 9.1.4.	N/A
	Openings in the top and sides of ENCLOSURES shall be so located or constructed that it is unlikely that objects will enter the openings and create hazards by contacting bare conductive parts.		N/A
13.6	Polymeric Materials		N/A
13.6.1	General		N/A
13.6.1.1	Thermal index or capability		N/A
13.6.2	Polymers serving as enclosures or barriers preventing access to hazards		N/A
13.6.2.1	Stress relief test		N/A
13.6.3	Polymers serving as solid insulation	Considered.	P
13.6.3.1	Resistance to arcing	Considered.	P
13.6.4	UV resistance	LCD screen and external plastic terminals with UV resistance cover, more informations see appended table 14.	P
	Polymeric parts of an OUTDOOR ENCLOSURE required for compliance with this standard shall be sufficiently resistance to degradation by ultra-violet (UV) radiation		P
13.7	Mechanical resistance to deflection, impact, or drop		P
13.7.1	General		P
13.7.2	250-N deflection test for metal enclosures	No hazards.	P
13.7.3	7-J impact test for polymeric enclosures	No hazards.	P
13.7.4	Drop test	Not a hand-held, direct plug-in and transportable equipment.	N/A
13.8	Thickness requirements for metal enclosures		N/A
13.8.1	General	The metal enclosure complied with 13.7.	N/A
13.8.2	Cast metal		N/A
13.8.3	Sheet metal		N/A
13.9 of IEC 62109-2	Fault indication	See below.	P
	Where this Part 2 requires the inverter to indicate a fault, both of the following shall be provided:	LCD screen or interface connected to PC as fault indication.	P
	a) a visible or audible indication, integral to the inverter, and detectable from outside the inverter, and	LCD screen shown fault information.	P
	b) an electrical or electronic indication that can be remotely accessed and used.	RS485/USB/Bluetooth can be used for communication between PCE and PC.	P



IEC/EN 62109-1, IEC/EN 62109-2			
Clause	Requirement – Test	Result – Remark	Verdict
	The installation instructions shall include information regarding how to properly make connections (where applicable) and use the electrical or electronic means in b) above, in accordance with 5.3.2.10.	The instructions are specified in section “Installation” of the Productmanual.	P
14	COMPONENTS		P
14.1	General		P
	Where safety is involved, components shall be used in accordance with their specified RATINGS unless a specific exception is made. They shall conform to one of the following:	Considered.	P
	a) applicable safety requirements of a relevant IEC standard. Conformity with other requirements of the component standard is not required. If necessary for the application, components shall be subjected to the test of this standard, except that it is not necessary to carry out identical or equivalent tests already performed to check conformity with the component standard;	Considered.	P
	b) the requirements of this standard and, where necessary for the application, any additional applicable safety requirements of the relevant IEC component standard;	Considered.	P
	c) if there is no relevant IEC standard, the requirements of this standard;	Considered.	P
	d) applicable safety requirements of a non-IEC standard which are at least as high as those of the applicable IEC standard, provided that the component has been approved to the non-IEC standard by a recognized testing authority.	Considered.	P
	Components such as optocouplers, capacitors, transformers, and relays connected across basic, supplemental, reinforced, or double insulation shall comply with the requirements applicable for the grade of insulation being bridged, and if not previously certified to the applicable component safety standard shall be subjected to the voltage test of 7.5.2 as routine test.	Considered.	P
14.2	Motor Overtemperature Protection		N/A
	Motors which, when stopped or prevented from starting (see 4.4.4.3), would present an electric shock HAZARD, a temperatur HAZARD, or a fire HAZARD, shall be protected by an overtemperature or thermal protection device meeting the requirements of 14.3.		N/A
14.3	Overtemperature protection devices	No such devices.	N/A
14.4	Fuse holders		N/A
14.5	MAINS voltage selecting devices	No such devices.	N/A
14.6	Printed circuit boards		P



IEC/EN 62109-1, IEC/EN 62109-2			
Clause	Requirement – Test	Result – Remark	Verdict
	Printed circuit boards shall be made of material with a flammability classification of V-1 of IEC 60707 or better.	V-0 PCBs used.	P
	This requirements does not apply to thin-film flexible printed circuit boards that contain only circuits powered from limited power sources meeting the requirements of 9.2.		P
	Conformity of the flammability RATING is checked by inspection of data on the materials. Alternatively, conformity is checked by performing the V-1 tests specified in IEC 60707 on three samples of the relevant parts.		P
14.7	Circuits or components used as transient overvoltage limiting devices		P
	If control of transient overvoltage is employed in the equipment, any overvoltage limiting component or circuit shall be tested with the applicable impulse withstand voltage of Table 7-10 using the test method from 7.5.1 except 10 positive and 10 negative impulses are to be applied and may be spaced up to 1 min apart.	Considered.	P
14.8	Batteries		N/A
	Equipment containing batteries shall be designed to reduce the risk of fire, explosion and chemical leaks under normal conditions and after a single fault in the equipment including a fault in circuitry within the equipment battery pack.	No such devices.	N/A
14.8.1	Battery Enclosure Ventilation		N/A
14.8.1.1	Ventilation requirements		N/A
14.8.1.2	Ventilation testing		N/A
14.8.1.3	Ventilation instructions		N/A
14.8.2	Battery Mounting		N/A
	Compliance is verified by the application of the force to the battery's mounting surface. The test force is to be increased gradually so as to reach the required value in 5 to 10 s, and is to be maintained at that value for 1 min. A nonmetallic rack or tray shall be tested at the highest normal condition operating temperature.		N/A
14.8.3	Electrolyte spillage		N/A
	Battery trays and cabinets shall have an electrolyte-resistant coating.		N/A
	The ENCLOSURE or compartment housing a VENTED BATTERY shall be constructed so that spillage or leakage of the electrolyte from one battery will be contained within the ENCLOSURE and be prevented from:		N/A
	a) reaching the PCE outer surfaces that can be contacted by the USER		N/A
	b) contaminating adjacent electrical components or materials; and		N/A
	c) bridging required electrical distances		N/A
14.8.4	Battery Connections		N/A



IEC/EN 62109-1, IEC/EN 62109-2			
Clause	Requirement – Test	Result – Remark	Verdict
	Reverse battery connection of the terminals shall be prevented if reverse connection could result in a hazard within the meaning of this Standard		N/A
14.8.5	Battery maintenance instructions		N/A
	The information and instructions listed in 5.3.4.1 shall be included in the operator manual for equipment in which battery maintenance is performed by the operator, or in the service manual if battery maintenance is to be performed by service personnel only.		N/A
14.8.6	Battery accessibility and maintainability		N/A
	Battery terminals and connectors shall be accessible for maintenance with the correct TOOLS. Batteries with liquid electrolyte, requiring maintained shall be so located that the battery cell caps are accessible for electrolyte tests and readjusting of electrolyte levels.		N/A
15	Software and firmware performing safety functions	The software evaluated according to IEC 60730 annex H. See separated software evaluation report for detail.	P

Annex B	Programmable equipment		P
B.1	Software or firmware that performs safety critical functions	The software evaluated according to IEC 60730 annex H. See separated software evaluation report for detail.	P
B.1.1	Firmware or software that performs a critical safety function/s, such as protection from excessive temperature, over current or improper synchronization of AC sources, the failure of which can result in a risk of fire, electric shock or other hazard as specified by this standard, shall be evaluated by one of the following means.	The software evaluated according to IEC 60730 annex H. See separated software evaluation report for detail.	P
	a) All software or firmware limits or controls shall be disabled before the test to evaluate the hardware circuitry during the abnormal test condition related to the safety function, or the hardware sensor component that is monitored by the firmware or software is modified or disabled to prevent the software or firmware from reading or responding to the abnormal condition.		N/A
	b) Protective controls employing software or firmware to perform their function(s) shall be so constructed that they comply with IEC 60730-1 Annex H to address the risks identified in B.2.1. Each combination of microprocessor model, manufacturer and firmware/software version used in the production of a PCE shall be evaluated as specified in the remainder of Annex B.	The software evaluated according to IEC 60730 annex H. See separated software evaluation report for detail.	P



IEC/EN 62109-1, IEC/EN 62109-2			
Clause	Requirement – Test	Result – Remark	Verdict
	Exception: For units with firmware/software that has been found to be compliant with the remainder of Annex B, subsequent firmware/software revisions may be entitled to a limited reevaluation for the revised firmware or software. The scope of the reevaluation shall be defined by the potential impact of the firmware or software revisions and the applicable portions of IEC 60730-1 Annex H shall be reapplied.		P
B.2	Evaluation of controls employing software	The software evaluated according to IEC 60730 annex H. See separated software evaluation report for detail.	P
B.2.1.1	A risk analysis shall be conducted to determine a set of risks and that the software addresses the identified risks. The risk analysis shall be conducted based on the safety requirements for the programmable component.		P
B.2.1.2	An analysis shall be conducted to identify the critical, non-critical, and supervisory parts of the software.		P
B.2.1.3	An analysis shall be conducted to identify transitions or states that can result in a risk.		P
B.2.1.4	Risks to be considered include, but are not limited to functions associated with the following:		P
	a) Temperature control, monitoring and response (i.e. coolant, internal ambient, device)		P
	b) Safety interlocks		P
	c) Synchronization between multiple AC sources		P
	d) Emergency stop of operation (including staged shutdown / sequencing)		P
	e) Connection / disconnection – from an input source and output source		P
	f) RCD functions		P
	g) Over current protection or control		P

Annex J	Ultraviolet light conditioning test		N/A
J.1	General	LCD screen and external plastic terminals with UV resistance cover, more informations see appended table 14.	N/A
	Samples mounted as in Clause J.2 are to be exposed to ultraviolet light by using either the apparatus in Clauses J.3 or J.4, and shall comply with the criteria in 13.6.4.		N/A
J.2	Mounting of test samples		N/A
	The samples are mounted vertically on the inside of the cylinder of the light exposure apparatus, with the widest portion of the sample facing the arcs. They are mounted so that they do not touch each other.		N/A
J.3	Carbon-arc light-exposure apparatus		N/A



IEC/EN 62109-1, IEC/EN 62109-2			
Clause	Requirement – Test	Result – Remark	Verdict
	The apparatus described in ISO 4892-4, or equivalent, is used in accordance with the procedures given in ISO 4892-1 and ISO 4892-4 using a type 1 filter, with water spray.		N/A
J.4	Xenon-arc light-exposure apparatus		N/A
	The apparatus described in ISO 4892-2, or equivalent, is used in accordance with the procedures given in ISO 4892-1 and ISO 4892-2 using method A, with water spray.		N/A



**BUREAU
VERITAS**

Test Report No: LD200511N080

4.2.2.6 TABLE: mains supply electrical data in normal condition						P
Type	U (V)	I (A) DC	P (kW) DC	U (V)	I (A) AC	P (kW) AC
SOFAR 15KTLX-G3	140	5.371	0.750	230V/50Hz	1.057	0.685
SOFAR 15KTLX-G3	420	36.625	15.410	230V/50Hz	21.710	14.998
SOFAR 15KTLX-G3	650	23.692	15.383	230V/50Hz	21.698	15.022
SOFAR 15KTLX-G3	850	18.178	15.430	230V/50Hz	21.760	14.992
SOFAR 15KTLX-G3	1100*	0	0	230V/50Hz	0	0
SOFAR 15KTLX-G3	140	5.374	0.750	230V/60Hz	1.069	0.686
SOFAR 15KTLX-G3	420	36.586	15.411	230V/60Hz	21.714	14.999
SOFAR 15KTLX-G3	650	23.794	15.404	230V/60Hz	21.733	15.047
SOFAR 15KTLX-G3	850	18.223	15.507	230V/60Hz	21.687	15.016
SOFAR 15KTLX-G3	1100	0	0	230V/60Hz	0	0
SOFAR 17KTLX-G3	140	5.371	0.750	230V/50Hz	1.057	0.685
SOFAR 17KTLX-G3	450	38.271	17.315	230V/50Hz	24.447	16.920
SOFAR 17KTLX-G3	650	26.849	17.432	230V/50Hz	24.591	17.024
SOFAR 17KTLX-G3	850	20.578	17.487	230V/50Hz	24.665	16.994
SOFAR 17KTLX-G3	1100	0	0	230V/50Hz	0	0
SOFAR 17KTLX-G3	140	5.373	0.751	230V/60Hz	1.068	0.686
SOFAR 17KTLX-G3	450	39.167	17.545	230V/60Hz	24.536	16.967
SOFAR 17KTLX-G3	650	26.831	17.461	230V/60Hz	24.593	17.028
SOFAR 17KTLX-G3	850	20.640	17.574	230V/60Hz	24.541	16.991
SOFAR 17KTLX-G3	1100	0	0	230V/60Hz	0	0
SOFAR 20KTLX-G3	140	7.356	1.027	230V/50Hz	1.448	0.951
SOFAR 20KTLX-G3	480	42.709	20.460	230V/50Hz	28.738	19.892
SOFAR 20KTLX-G3	650	31.594	20.511	230V/50Hz	28.947	20.035
SOFAR 20KTLX-G3	850	24.237	20.572	230V/50Hz	29.012	19.989
SOFAR 20KTLX-G3	1100	0	0	230V/50Hz	0	0
SOFAR 20KTLX-G3	140	7.359	1.028	230V/60Hz	1.452	0.952
SOFAR 20KTLX-G3	480	43.028	20.677	230V/60Hz	28.902	19.998
SOFAR 20KTLX-G3	650	31.502	20.488	230V/60Hz	28.957	20.032
SOFAR 20KTLX-G3	850	24.199	20.584	230V/60Hz	28.849	19.959
SOFAR 20KTLX-G3	1100	0	0	230V/60Hz	0	0
SOFAR 22KTLX-G3	140	7.355	1.027	230V/50Hz	1.448	0.951
SOFAR 22KTLX-G3	510	44.365	22.546	230V/50Hz	31.717	21.954
SOFAR 22KTLX-G3	650	34.663	22.557	230V/50Hz	31.818	22.028
SOFAR 22KTLX-G3	850	26.660	22.633	230V/50Hz	31.918	21.991
SOFAR 22KTLX-G3	1100*	0	0	230V/50Hz	0	0
SOFAR 22KTLX-G3	140	7.359	1.028	230V/60Hz	1.452	0.952
SOFAR 22KTLX-G3	510	44.591	22.692	230V/60Hz	31.706	21.948
SOFAR 22KTLX-G3	650	34.692	22.556	230V/60Hz	31.816	22.022
SOFAR 22KTLX-G3	850	26.781	22.783	230V/60Hz	31.863	22.056
SOFAR 22KTLX-G3	1100*	0	0	230V/60Hz	0	0



**BUREAU
VERITAS**

Test Report No: LD200511N080

SOFAR 24KTLX-G3	140	9.338	1.305	230V/50Hz	1.834	1.218
SOFAR 24KTLX-G3	540	45.657	24.613	230V/50Hz	34.675	24.001
SOFAR 24KTLX-G3	650	37.885	24.630	230V/50Hz	34.754	24.060
SOFAR 24KTLX-G3	850	29.080	24.693	230V/50Hz	34.801	23.994
SOFAR 24KTLX-G3	1100*	0	0	230V/50Hz	0	0
SOFAR 24KTLX-G3	140	9.343	1.306	230V/60Hz	1.835	1.219
SOFAR 24KTLX-G3	540	46.010	24.807	230V/60Hz	34.638	23.989
SOFAR 24KTLX-G3	650	37.969	24.651	230V/60Hz	34.714	24.039
SOFAR 24KTLX-G3	850	29.226	24.882	230V/60Hz	34.720	24.044
SOFAR 24KTLX-G3	1100*	0	0	230V/60Hz	0	0
supplementary information						
“**” The PCE can not normal operator when the input DC voltage is more than 1030Vdc cause the input voltage limited protection of Software design						



4.3	TABLE: heating temperature rise measurements(SOFAR 24KTLX-G3)					P
	test voltage (V)	540Vdc	850Vdc	540Vdc	850Vdc	—
	t1 (°C)	45.0	45.0	45.0	45.0	—
	t2 (°C)	45.2	44.9	44.6	44.7	—
	temperature rise dT of part/at:	dT (°C)				permitted dT (°C)
Outside fan 1	54.3	53.7	53.1	52.7	70	
Outside fan 2	57.9	59.1	56.9	57.4	70	
PV input connector	48.3	47.9	47.8	47.2	85	
DC switch handle	46.8	46.8	46.8	46.1	85	
LCD display button	54.7	55.8	53.9	52.9	100*	
AC terminals	58.3	58.2	55.2	54.9	105	
Enclosure surface	61.7	63.8	61.1	58.7	100*	
Enclosure side	62.8	66.6	61.4	59.9	100*	
Mounting surface	62.8	72.5	60.8	64.8	100*	
Q6	80.1	105.3	74.1	85.8	130	
Q13	92.4	110.9	83.2	96.8	130	
Q3	96.2	115.5	86.4	100.8	130	
Q8	85.5	101.2	81.0	83.4	130	
D2	92.2	79.2	87.8	70.5	130	
Q14	84.6	72.6	88.0	65.9	130	
Q50	78.8	70.5	81.9	65.4	130	
D98	75.1	77.1	75.0	70.2	130	
CY1	67.0	64.7	68.7	60.6	85	
Varistor MOV1	69.4	68.8	69.9	63.6	125	
Input DC SPD F4	68.2	67.3	67.8	62.5	85	
Winding of T1 transformer	74.8	77.5	73.3	71.3	130	
Core of T1 transformer	74.6	77.5	73.5	71.0	130	
Winding of T3 transformer	72.6	74.9	72.3	68.6	130	
Core of T3 transformer	72.1	73.9	71.4	67.6	130	
Winding of EMI inductor L1	80.7	72.8	92.1	67.3	130	
C16	69.4	69.9	70.8	63.8	105	
HCT1	69.9	70.6	70.7	64.3	105	
Relay RL2	78.9	82.6	74.3	73.0	105	
Winding of EMI inductor L2	96.4	104.1	86.8	87.1	130	
Winding of GFCI LP2	81.0	85.6	76.2	74.5	130	
Core of EMI inductor L2	86.9	98.2	81.9	82.1	130	
Y-Cap CY26	76.1	80.3	72.8	70.6	85	
C62	77.2	80.9	73.5	71.6	105	
Winding of EMI inductor L3	96.1	100.6	86.7	84.6	130	
Varistor MOV5	75.6	79.3	72.5	70.0	125	
R phase INV Inductor	101.5	107.5	86.6	96.1	130	
T phase INV Inductor	106.1	107.5	78.1	109.1	130	
C32	79.0	83.7	75.6	73.5	105	
Line of INV inductor	79.5	83.5	75.2	73.3	105	
C34	78.5	86.0	75.2	74.5	105	
VU11	76.8	83.4	74.3	73.5	105	
HCT6	82.0	81.3	74.7	80.3	85	
C35	75.1	80.7	72.6	70.9	105	
Relay RL5	82.5	86.4	77.4	76.8	105	
C65	73.2	76.1	70.2	67.8	110	



CAS1	73.4	76.5	70.5	68.3	90
AC line	77.7	78.3	72.2	70.6	105
DSP U13	73.2	76.1	70.9	69.3	85
DSP U30	76.4	76.7	72.1	71.1	125
PCB	88.7	105.7	82.0	87.7	130
PV line	46.8	46.9	46.2	46.3	105
ISO relay RY2	70.0	70.5	70.5	64.3	85
Winding of boost1 inductor	72.2	66.3	78.9	61.0	130
Winding of boost2 inductor	78.5	68.8	89.7	62.6	130
CTF9	69.8	70.7	69.6	64.6	105
UV2	76.0	75.8	75.6	68.5	130
Line of boost inductor	70.6	70.4	71.5	63.8	105
CTF5	77.1	83.3	74.1	72.8	105
DC switch body	65.6	62.7	66.6	59.8	85
UV1	82.7	83.0	78.2	75.7	130

supplementary information:

45°C Input 540Vdc/45.9A, Output 207Vac/50Hz/38.4A/23.8kW.

45°C Input 850Vdc/28.8A, Output 207Vac/50Hz/38.3A/23.9kW.

45°C Input 540Vdc/45.9A, Output 253Vac/50Hz/31.6A/23.9kW

45°C Input 850Vdc/28.9A, Output 253Vac/50Hz/A/24.0kW

*Symbol 14 of annex C used.



4.3	TABLE: heating temperature rise measurements(SOFAR 24KTLX-G3)					P
	test voltage (V)	540Vdc	850Vdc	540Vdc	850Vdc	—
	t1 (°C)	60.0	60.0	60.0	60.0	—
	t2 (°C)	61.6	60.6	60.4	60.3	—
	temperature rise dT of part/at:	dT (°C)				permitted dT (°C)
Outside fan 1	66.0	67.3	66.9	66.2	70	
Outside fan 2	65.0	66.9	67.3	66.9	70	
PV input connector	65.0	62.8	63.3	62.4	85	
DC switch handle	63.2	61.9	62.2	61.4	85	
LCD display button	69.6	67.9	68.2	67.2	100*	
AC terminals	72.7	69.6	69.7	68.8	105	
Enclosure surface	74.3	73.4	74.4	72.7	100*	
Enclosure side	75.5	75.5	74.4	74.8	100*	
Mounting bracket	78.6	80.4	76.1	79.0	100*	
Q6	94.7	105.6	90.9	99.7	130	
Q13	102.9	108.9	98.1	107.2	130	
Q3	106.3	111.3	100.4	110.3	130	
Q8	97.6	98.0	94.5	94.2	130	
D2	99.5	85.7	99.4	84.1	130	
Q14	93.6	80.9	100.8	79.7	130	
Q50	87.5	79.5	94.4	78.7	130	
D98	85.6	83.7	87.8	83.0	130	
CY1	77.5	74.4	80.7	73.9	85	
Varistor MOV1	80.2	77.5	81.8	76.8	125	
F4	78.4	76.4	80.4	75.7	85	
Winding of T1 transformer	86.4	85.3	86.1	84.3	110	
Core of T1 transformer	86.2	85.3	86.3	84.2	110	
Winding of T3 transformer	83.8	83.5	85.4	82.6	110	
Core of T3 transformer	83.1	82.4	84.3	81.4	110	
Winding of EMI inductor L1	86.5	79.4	97.8	79.7	130	
C16	79.9	78.3	82.7	77.4	105	
HCT1	80.4	78.8	82.9	77.9	105	
Relay RL2	87.8	87.9	86.6	86.0	105	
Winding of EMI inductor L2	102.4	108.1	98.2	103.6	130	
Winding of GFCI LP2	91.8	90.2	88.2	88.2	130	
Core of EMI inductor L2	97.1	108.9	94.6	103.3	130	
CY26	80.9	82.7	83.2	82.4	85	
C62	87.0	86.0	85.9	84.8	105	
Winding of EMI inductor L3	102.3	98.9	97.2	96.9	130	
Varistor MOV5	85.7	85.1	84.8	83.7	125	
R phase INV Inductor winding	102.1	102.5	97.9	99.1	130	
T phase INV Inductor winding	99.3	101.7	91.1	98.2	130	
C32	88.4	87.7	88.0	86.2	105	
Line of INV inductor winding	89.8	88.0	87.4	85.6	105	
C34	90.3	89.6	87.8	87.7	105	
VU11	87.8	88.7	87.3	86.7	105	
HCT6	81.6	82.2	81.7	81.7	85	
C35	85.8	86.1	85.2	84.5	105	
Relay RL5	91.5	90.7	89.2	88.7	105	
C65	83.6	82.4	82.9	81.1	110	



CAS1	83.9	82.9	83.1	81.5	90
AC line	85.7	83.4	84.4	82.3	105
DSP U13	84.2	84.0	84.0	82.8	130
DSP U30	84.5	83.7	84.9	82.5	130
PCB	99.1	103.1	95.3	99.9	130
PV line	62.3	62.2	61.9	61.7	105
ISO relay RY2	80.2	78.7	82.7	77.7	85
Winding of boost1 inductor	80.7	75.8	89.2	74.8	130
Winding of boost2 inductor	85.1	77.8	98.3	76.4	130
CTF9	80.2	79.0	82.1	78.0	105
UV2	86.0	83.0	87.9	81.9	130
Line of boost inductor	80.7	78.7	83.4	77.7	105
CTF5	87.6	87.9	87.0	86.0	105
DC switch body	75.8	73.1	78.3	72.8	85
UV1	91.0	88.0	90.2	86.7	130

supplementary information:

60°C Input 542Vdc/43.7A, Output 207Vac/50Hz/37.8A/23.5kW(derating).

60°C Input 847Vdc/28.4A, Output 207Vac/50Hz/37.7A/23.4kW(derating).

60°C Input 542Vdc/43.8A, Output 253Vac/50Hz/30.9A/23.4kW(derating).

60°C Input 847Vdc/27.3A, Output 253Vac/50Hz/31.2A/23.5kW(derating).

*Symbol 14 of annex C used.



4.3	TABLE: heating temperature rise measurements(SOFAR 24KTLX-G3)		P	
	test voltage (V)	540Vdc	850Vdc	—
	t1 (°C)	45.0	45.0	—
	t2 (°C)	45.8	44.6	—
	temperature rise dT of part/at:	dT (°C)		permitted dT (°C)
	Outside fan 1	54.4	52.0	70
	Outside fan 2	55.2	53.1	70
	PV input connector	48.7	46.5	85
	DC switch handle	48.6	46.6	85
	LCD display button	55.1	51.1	100*
	AC terminals	58.2	54.2	105
	Enclosure surface	64.3	57.3	100*
	Enclosure side	64.4	59.5	100*
	Mounting bracket	64.6	62.9	100*
	Q6	83.3	79.5	130
	Q13	94.0	90.9	130
	Q3	95.1	91.4	130
	Q8	87.0	74.7	130
	D2	94.7	67.8	130
	Q14	88.7	63.8	130
	Q50	81.5	63.8	130
	D98	77.7	68.0	130
	CY1	68.2	58.9	85
	Varistor MOV1	71.2	61.7	125
	F4	69.9	60.6	85
	Winding of T1 transformer	76.3	68.3	130
	Core of T1 transformer	75.9	67.6	130
	Winding of T3 transformer	74.9	65.7	130
	Core of T3 transformer	74.1	65.1	130
	Winding of EMI inductor L1	84.5	66.6	130
	C16	71.6	61.9	105
	HCT1	72.2	62.2	105
	Relay RL2	82.6	70.4	105
	Winding of EMI inductor L2	99.7	85.2	130
	Winding of GFCI LP2	83.3	72.1	130
	Core of EMI inductor L2	92.7	82.0	130
	CY26	78.2	68.4	85
	C62	79.2	69.2	105
	Winding of EMI inductor L3	99.8	83.2	130
	Varistor MOV5	77.0	67.5	125
	R phase INV Inductor	94.6	79.1	130
	T phase INV Inductor	88.1	79.1	130
	C32	81.5	70.6	105
	Line of INV inductor	82.3	70.9	105
	C34	81.3	71.7	105
	VU11	79.2	70.1	105
	HCT6	82.9	75.1	85
	C35	77.7	68.2	105
	Relay RL5	84.1	73.1	105



**BUREAU
VERITAS**

Test Report No: LD200511N080

C65	75.0	65.4	110
CAS1	75.8	65.9	90
AC line	77.4	66.9	105
DSP U13	74.3	66.8	85
DSP U30	72.6	63.9	125
PCB	92.0	83.4	130
PV line	47.5	45.6	105
ISO relay RY2	72.1	62.3	85
Winding of boost1 inductor	74.9	59.2	130
Winding of boost2 inductor	81.5	60.1	130
CTF9	72.5	62.8	105
UV2	78.6	66.3	130
Line of boost inductor	72.9	61.9	105
CTF5	73.8	70.0	105
DC switch body	67.4	58.6	85
UV1	78.4	66.1	130
supplementary information: 45°C Input 540Vdc/45.3A, Output 207Vac/60Hz/38.4A/23.9kW. 45°C Input 850Vdc/28.5A, Output 253Vac/60Hz/31.5A/24.0kW *Symbol 14 of annex C used.			



**BUREAU
VERITAS**

Test Report No: LD200511N080

4.3	TABLE: heating temperature rise measurements(SOFAR 15KTLX-G3)					P
	test voltage (V)	420Vdc	850Vdc	420Vdc	850Vdc	—
	t1 (°C)	45.0	45.0	60.0	60.0	—
	t2 (°C)	45.4	45.1	59.7	60.0	—
	temperature rise dT of part/at:	dT (°C)				permitted dT (°C)
Outside fan 1	52.3	51.7	67.6	66.9	70	
PV input connector	47.5	46.5	62.0	61.4	85	
DC switch handle	47.5	46.5	62.3	61.4	85	
LCD display button	49.9	48.6	65.7	63.4	100*	
AC terminals	52.1	50.2	66.9	65.1	105	
Enclosure surface	56.3	53.4	72.2	68.4	100*	
Enclosure side	55.8	53.9	71.8	69.0	100*	
Mounting bracket	60.0	60.1	76.5	75.8	100*	
Q6	72.1	73.6	88.2	90.1	130	
Q13	74.8	75.2	93.2	92.2	130	
Q3	76.3	76.4	93.0	93.6	130	
Q8	73.4	67.0	90.3	83.0	130	
D2	79.1	62.6	96.7	78.5	130	
Q14	79.7	60.7	97.9	76.4	130	
Q50	75.3	60.3	92.5	75.9	130	
D98	68.3	61.6	84.5	77.1	130	
CY1	63.0	55.8	77.4	70.8	85	
Varistor MOV1	63.1	56.6	79.1	71.8	125	
F4	62.2	56.1	78.1	71.2	85	
Winding of T1 transformer	66.7	63.7	82.2	78.5	130	
Core of T1 transformer	66.5	63.4	81.7	78.2	130	
Winding of T3 transformer	66.1	61.2	82.1	76.6	130	
Core of T3 transformer	65.1	60.4	81.1	75.6	130	
Winding of EMI inductor L1	73.2	58.6	90.2	73.8	130	
C16	63.7	57.3	78.5	72.4	105	
HCT1	64.8	57.9	78.6	73.1	105	
Relay RL2	64.2	60.0	81.6	75.4	85	
Winding of EMI inductor L2	73.0	71.4	88.7	87.2	130	
Winding of GFCI LP2	66.1	62.3	81.8	77.7	130	
Core of EMI inductor L2	70.5	72.5	80.6	88.2	130	
CY26	64.0	60.2	79.5	75.6	85	
C62	65.1	61.0	80.7	76.4	105	
Winding of EMI inductor L3	72.1	66.1	88.4	81.7	130	
Varistor MOV5	63.7	59.5	78.9	75.0	125	
R phase INV Inductor	71.2	66.7	86.4	82.4	130	
T phase INV Inductor	67.7	67.1	91.9	83.2	130	
C32	66.6	61.8	82.5	77.4	105	
Line of INV inductor	66.1	61.5	82.8	76.9	105	
C34	66.2	62.5	82.6	78.0	105	
VU11	68.2	64.3	82.7	80.2	105	
HCT6	68.6	63.9	83.2	79.2	85	
C35	64.3	60.4	80.0	75.7	105	
Relay RL5	66.7	62.7	83.2	78.0	85	
C65	64.0	58.7	77.8	73.6	110	
CAS1	62.9	58.5	78.1	74.0	90	



**BUREAU
VERITAS**

Test Report No: LD200511N080

AC line	63.3	58.4	78.8	73.8	105
DSP U13	64.6	61.0	78.7	76.4	85
DSP U30	64.0	59.7	78.5	75.1	125
PCB	73.4	71.6	82.5	86.7	130
PV line	46.8	46.1	60.9	61.2	105
ISO relay RY2	63.6	57.4	78.5	72.6	85
Winding of boost1 inductor	67.7	55.4	82.7	70.6	130
Winding of boost2 inductor	73.4	56.6	88.4	71.9	130
CTF9	63.1	57.7	78.7	72.9	105
UV2	66.9	59.6	82.8	75.0	130
Line of boost inductor	64.3	57.1	79.2	72.3	105
CTF5	67.7	62.1	81.1	77.1	105
DC switch body	60.9	54.3	75.2	69.3	85
UV1	71.2	65.0	87.1	80.6	130

supplementary information:

45°C Input 416Vdc/36.8A, Output 207Vac/50Hz/24.1 A/14.9kW.

45°C Input 850Vdc/18.0A, Output 253Vac/50Hz/19.8A/15.1kW.

60°C Input 414Vdc/36.0A, Output 207Vac/50Hz/23.9A/14.7kW(derating).

60°C Input 850Vdc/15.4A, Output 253Vac/50Hz/19.8A/14.9kW(derating).

*Symbol 14 of annex C used.



**BUREAU
VERITAS**

Test Report No: LD200511N080

TABLE: Abnormal heating temperature rise measurements (SOFAR 24KTLX-G3)			P
	Blanketing blocked	Fan blocked	
test voltage (V)	650V	650V	—
t1 (°C)	20.0	20.0	—
t2 (°C)	29.2	31.0	—
temperature rise dT of part/at:	dT (°C)		permitted dT (°C)
Outside fan 1	49.0	47.1	70
Outside fan 2	52.5	49.5	70
PV input connector	41.7	39.2	85
DC switch handle	36.1	37.0	85
LCD display button	58.3	43.7	100*
AC terminals	50.6	49.8	105
Enclosure surface	66.9	51.3	100*
Enclosure side	64.9	60.1	100*
Mounting bracket	64.5	70.1	100*
Q6	77.5	92.9	130
Q13	88.5	102.3	130
Q3	89.9	105.5	130
Q8	71.9	84.9	130
D2	67.0	78.3	130
Q14	63.4	73.7	130
Q50	63.8	72.1	130
D98	71.6	80.1	130
CY1	60.3	59.6	85
Varistor MOV1	64.5	64.1	125
F4	63.5	62.1	85
Winding of T1 transformer	72.9	67.5	130
Core of T1 transformer	72.8	67.8	130
Winding of T3 transformer	68.8	67.9	130
Core of T3 transformer	68.9	67.4	130
Winding of EMI inductor L1	73.1	78.4	130
C16	67.8	67.8	105
HCT1	67.8	71.2	105
Relay RL2	77.0	79.9	105
Winding of EMI inductor L2	92.6	108.1	130
Winding of GFCI LP2	79.3	96.1	130
Core of EMI inductor L2	86.7	103.6	130
CY26	74.8	80.4	85
C62	75.9	72.7	105
Winding of EMI inductor L3	91.7	101.9	130
Varistor MOV5	73.6	75.5	125
R phase INV Inductor	86.5	100.4	130
T phase INV Inductor	85.6	101.3	130
C32	76.3	87.3	105
Line of INV inductor	77.9	94.2	105
C34	77.1	91.8	105
VU11	75.3	83.7	105
HCT6	83.3	80.6	85



**BUREAU
VERITAS**

Test Report No: LD200511N080

C35	74.7	83.4	105
Relay RL5	79.9	87.1	105
C65	71.9	71.8	110
CAS1	72.5	72.6	90
AC line	74.3	70.1	105
DSP U13	71.5	66.0	85
DSP U30	71.6	73.3	125
PCB	86.4	100.1	130
PV line	32.4	31.0	105
ISO relay RY2	67.8	69.5	85
Winding of boost1 inductor	64.3	65.7	130
Winding of boost2 inductor	64.9	74.2	130
CTF9	68.4	68.9	105
UV2	71.7	77.4	130
Line of boost inductor	67.7	65.1	105
CTF5	76.1	85.3	105
DC switch body	59.7	54.0	85
UV1	76.0	89.0	130

supplementary information:

Fan blocked, Input 698Vdc/30.2A, Output 230Vac/50Hz/30.0A/20.7kW (derating).

Blanketing blocked, Input 650Vdc/37.6A, Output 230Vac/50Hz/34.8A/24.0kW.

*Symbol 14 of annex C used.



4.4		TABLE: fault condition tests							P
		ambient temperature (°C)						: 24.8	—
component No.	fault	test condition		test time	fuse No.	fault condition		result	
		AC	DC			AC	DC		
R5	Short	230V 35A	850V 29A	10min.	--	230V 35A	850V 29A	Inverter operated normally. No damaged.No hazard.	
R12	Short	230V 35A	850V 29A	10min.	--	230V 35A	850V 29A	Inverter operated normally. No damaged.No hazard.	
R3	Short	230V 35A	850V 29A	10min.	--	230V <1A	850V <1A	Inverter disconnected from grid immediately. Error message:" HwPVOCP". No damaged.No hazard.	
R852	Short	230V 35A	850V 29A	10min.	--	230V <1A	850V <1A	Inverter operated normally. No damaged.No hazard.	
U1 pin1-3	Short	230V 35A	850V 29A	10min.	--	230V <1A	850V <1A	I Inverter operated normally. No damaged.No hazard.	
Q50	Short	230V 35A	850V 29A	10min.	--	230V <1A	850V <1A	Inverter disconnected from grid immediately. Error message:" HwPVOCP". No damaged.No hazard.	
CTF4	Short	230V 35A	850V 29A	10min.	--	230V <1A	850V <1A	Inverter disconnected from grid immediately. Error message:" VbusRmsUnbalance". No damaged.No hazard.	
CTF9	Short	230V 35A	850V 29A	10min.	--	230V <1A	850V <1A	Inverter disconnected from grid immediately. Error message:" VbusRmsUnbalance". No damaged.No hazard.	
RL1	Short before start-up	230V <1A	850V <1A	10min.	--	230V <1A	850V <1A	Inverter did not start-up. Error message:" RelayTestFail". No damage.No hazard.	
RL2	Short before start-up	230V <1A	850V <1A	10min.	--	230V <1A	850V <1A	Inverter did not start-up. Error message:" RelayTestFail". No damage.No hazard.	
RL3	Short before start-up	230V <1A	850V <1A	10min.	--	230V <1A	850V <1A	Inverter did not start-up. Error message:" RelayTestFail". No damage.No hazard.	
RL4	Short before start-up	230V <1A	850V <1A	10min.	--	230V <1A	850V <1A	Inverter did not start-up. Error message:" RelayTestFail". No damage.No hazard.	



component No.	fault	test condition		test time	fuse No.	fault condition		result
		AC	DC			AC	DC	
RL5	Short before start-up	230V <1A	850V <1A	10min.	--	230V <1A	850V <1A	Inverter did not start-up. Error message:" RelayTestFail". No damage.No hazard.
RL6	Short before start-up	230V <1A	850V <1A	10min.	--	230V <1A	850V <1A	Inverter did not start-up. Error message:" RelayTestFail". No damage.No hazard.
R56	Open	230V 35A	850V 29A	10min.	--	230V 35A	850V 29A	Inverter operated normally. No damaged.No hazard.
R58	Short	230V 35A	850V 29A	10min.	--	230V 35A	850V 29A	Inverter operated normally. No damaged.No hazard.
R95	Open	230V 35A	850V 29A	10min.	--	230V 35A	850V 29A	Inverter operated normally. No damaged.No hazard.
R96	Open	230V 35A	850V 29A	10min.	--	230V 35A	850V 29A	Inverter operated normally. No damaged.No hazard.
R97	Open	230V 35A	850V 29A	10min.	--	230V 35A	850V 29A	Inverter operated normally. No damaged.No hazard.
R101	Short	230V 35A	850V 29A	10min.	--	230V 35A	850V 29A	Inverter operated normally. No damaged.No hazard.
R102	Short	230V 35A	850V 29A	10min.	--	230V 35A	850V 29A	Inverter operated normally. No damaged.No hazard.
R103	Short	230V 35A	850V 29A	10min.	--	230V 35A	850V 29A	Inverter operated normally. No damaged.No hazard.
R168	Open	230V 35A	850V 29A	10min.	--	230V <1A	850V <1A	Inverter disconnected from grid immediately. Error message:" IsoFault". No damaged.No hazard.
R169	Short	230V 35A	850V 29A	10min.	--	230V 35A	850V 29A	Inverter operated normally. No damaged.No hazard.
R22	Open	230V 35A	850V 29A	10min.	--	230V <1A	850V <1A	Inverter disconnected from grid immediately. Error message:" IsoFault". No damaged.No hazard.
R23	Short	230V 35A	850V 29A	10min.	--	230V 35A	850V 29A	Inverter operated normally. No damaged.No hazard.
R186	Open	230V 35A	850V 29A	10min.	--	230V <1A	850V <1A	Inverter disconnected from grid immediately. Error message:" IsoFault". No damaged.No hazard.
R188	Short	230V 35A	850V 29A	10min.	--	230V 35A	850V 29A	Inverter operated normally. No damaged.No hazard.
R193	Open	230V 35A	850V 29A	10min.	--	230V <1A	850V <1A	Inverter disconnected from grid immediately. Error message:" IsoFault". No damaged.No hazard.
R194	Short	230V 35A	850V 29A	10min.	--	230V 35A	850V 29A	Inverter operated normally. No damaged.No hazard.



component No.	fault	test condition		test time	fuse No.	fault condition		result
		AC	DC			AC	DC	
R174	Open	230V 35A	850V 29A	10min.	--	230V <1A	850V <1A	Inverter disconnected from grid immediately. Error message:" IsoFault". No damaged.No hazard.
R175	Short	230V 35A	850V 29A	10min.	--	230V 35A	850V 29A	Inverter operated normally. No damaged.No hazard.
R212	Open	230V 35A	850V 29A	10min.	--	230V <1A	850V <1A	Inverter disconnected from grid immediately. Error message:" IsoFault". No damaged.No hazard.
R207	Short	230V 35A	850V 29A	10min.	--	230V 35A	850V 29A	Inverter operated normally. No damaged.No hazard.
T1 pin6-8	Short	230V 35A	850V 29A	10min.	--	230V <1A	850V <1A	Non-display,Auxiliary source hiccup protections. No damaged.No hazard.
T1 pin3-5	Short	230V 35A	850V 29A	10min.	--	230V <1A	850V <1A	Non-display,Auxiliary source hiccup protections. No damaged.No hazard.
T1 pin1-2	Short	230V 35A	850V 29A	10min.	--	230V <1A	850V <1A	Non-display,Auxiliary source hiccup protections. No damaged.No hazard.
CAE1	Short	230V 35A	850V 29A	10min.	--	230V <1A	850V <1A	Non-display,Auxiliary source hiccup protections. No damaged.No hazard.
CAE3	Short	230V 35A	850V 29A	10min.	--	230V <1A	850V <1A	Non-display,Auxiliary source hiccup protections. No damaged.No hazard.
EC19	Short	230V 35A	850V 29A	10min.	--	230V <1A	850V <1A	Non-display,Auxiliary source hiccup protections. No damaged.No hazard.
R147	Short	230V 35A	850V 29A	10min.	--	230V <1A	850V <1A	Inverter disconnected from grid immediately. Error message:" AFCIFault". No damaged.No hazard.
R421	Open	230V 35A	850V 29A	10min.	--	230V <1A	850V <1A	Inverter disconnected from grid immediately. Error message:" AFCIFault". No damaged.No hazard.
R426	Open	230V 35A	850V 29A	10min.	--	230V <1A	850V <1A	Inverter disconnected from grid immediately. Error message:" AFCIFault". No damaged.No hazard.
C275	Short	230V 35A	850V 29A	10min.	--	230V <1A	850V <1A	Inverter disconnected from grid immediately. Error message:" AFCIFault". No damaged.No hazard.



component No.	fault	test condition		test time	fuse No.	fault condition		result
		AC	DC			AC	DC	
C270	Short	230V 35A	850V 29A	10min.	--	230V <1A	850V <1A	Inverter disconnected from grid immediately. Error message:" AFCIFault". No damaged.No hazard.
R146	Short	230V 35A	850V 29A	10min.	--	230V <1A	850V <1A	Inverter disconnected from grid immediately. Error message:" AFCIFault". No damaged.No hazard.
R413	Short	230V 35A	850V 29A	10min.	--	230V <1A	850V <1A	Inverter disconnected from grid immediately. Error message:" AFCIFault". No damaged.No hazard.
U5 pin12-14	Short	230V 35A	850V 29A	10min.	--	230V <1A	850V <1A	Inverter disconnected from grid immediately. Error message:" AFCIFault". No damaged.No hazard.
U5 pin10-8	Short	230V 35A	850V 29A	10min.	--	230V <1A	850V <1A	Inverter disconnected from grid immediately. Error message:" AFCIFault". No damaged.No hazard.
C252	Short	230V 35A	850V 29A	10min.	--	230V <1A	850V <1A	Inverter disconnected from grid immediately. Error message:" AFCIFault". No damaged.No hazard.
R411	Short	230V 35A	850V 29A	10min.	--	230V <1A	850V <1A	Inverter disconnected from grid immediately. Error message:" AFCIFault". No damaged.No hazard.
T5 Pin7-8-9-10-11-12	Short	230V 35A	850V 29A	10min.	--	230V <1A	850V <1A	Non-display,Auxiliary source hiccup protections. No damaged.No hazard.
T5 Pin5-6	Short	230V 35A	850V 29A	10min.	--	230V <1A	850V <1A	Non-display,Auxiliary source hiccup protections. No damaged.No hazard.
T5 Pin3-4	Short	230V 35A	850V 29A	10min.	--	230V <1A	850V <1A	Non-display,Auxiliary source hiccup protections. No damaged.No hazard.
T5 Pin17-18	Short	230V 35A	850V 29A	10min.	--	230V <1A	850V <1A	Non-display,Auxiliary source hiccup protections. No damaged.No hazard.
CAE5	Short	230V 35A	850V 29A	10min.	--	230V <1A	850V <1A	Non-display,Auxiliary source hiccup protections. No damaged.No hazard.
CAE7	Short	230V 35A	850V 29A	10min.	--	230V <1A	850V <1A	Non-display,Auxiliary source hiccup protections. No damaged.No hazard.



component No.	fault	test condition		test time	fuse No.	fault condition		result
		AC	DC			AC	DC	
CAE8	Short	230V 35A	850V 29A	10min.	--	230V <1A	850V <1A	Non-display,Auxiliary source hiccup protections. No damaged.No hazard.
CAE10	Short	230V 35A	850V 29A	10min.	--	230V <1A	850V <1A	Non-display,Auxiliary source hiccup protections. No damaged.No hazard.
CAE11	Short	230V 35A	850V 29A	10min.	--	230V <1A	850V <1A	Non-display,Auxiliary source hiccup protections. No damaged.No hazard.
CAE12	Short	230V 35A	850V 29A	10min.	--	230V <1A	850V <1A	Non-display,Auxiliary source hiccup protections. No damaged.No hazard.
CAE13	Short	230V 35A	850V 29A	10min.	--	230V <1A	850V <1A	Non-display,Auxiliary source hiccup protections. No damaged.No hazard.
R515	Short	230V 35A	850V 29A	10min.	--	230V 35A	850V 29A	Inverter operated normally. No damaged.No hazard.
R517	Open	230V 17A	850V 15A	10min.	--	230V 17A	850V 15A	MPPT1 operation failure, MPPT2 normal operation. Inverter operated normally. No damaged.No hazard.
R522	Short	230V 35A	850V 29A	10min.	--	230V 35A	850V 29A	Inverter operated normally. No damaged.No hazard.
R524	Open	230V 17A	850V 15A	10min.	--	230V 17A	850V 15A	MPPT1 operation failure, MPPT2 normal operation. Inverter operated normally. No damaged.No hazard.
R529	Short	230V 35A	850V 29A	10min.	--	230V 35A	850V 29A	Inverter operated normally. No damaged.No hazard.
R531	Open	230V 17A	850V 15A	10min.	--	230V 17A	850V 15A	MPPT2 operation failure, MPPT1 normal operation. Inverter operated normally. No damaged.No hazard.
R538	Short	230V 35A	850V 29A	10min.	--	230V 35A	850V 29A	Inverter operated normally. No damaged.No hazard.
R540	Open	230V 17A	850V 15A	10min.	--	230V 17A	850V 15A	MPPT2 operation failure, MPPT1 normal operation. Inverter operated normally. No damaged.No hazard.
R547	Short	230V 35A	850V 29A	10min.	--	230V <1A	850V <1A	Inverter disconnected from grid immediately. Error message:" VbusRmsUnbalance". No damaged.No hazard.



**BUREAU
VERITAS**

Test Report No: LD200511N080

component No.	fault	test condition		test time	fuse No.	fault condition		result
		AC	DC			AC	DC	
R549	Open	230V 35A	850V 29A	10min.	--	230V <1A	850V <1A	Inverter disconnected from grid immediately. Error message:" VbusRmsUnbalance". No damaged.No hazard.
R552	Short	230V 35A	850V 29A	10min.	--	230V <1A	850V <1A	Inverter disconnected from grid immediately. Error message:" VbusRmsUnbalance". No damaged.No hazard.
R554	Open	230V 35A	850V 29A	10min.	--	230V <1A	850V <1A	Inverter disconnected from grid immediately. Error message:" VbusRmsUnbalance". No damaged.No hazard.
R557	Short	230V 35A	850V 29A	10min.	--	230V <1A	850V <1A	Inverter disconnected from grid immediately. Error message:" VbusRmsUnbalance". No damaged.No hazard.
R559	Open	230V 35A	850V 29A	10min.	--	230V <1A	850V <1A	Inverter disconnected from grid immediately. Error message:" VbusRmsUnbalance". No damaged.No hazard.
R562	Short	230V 35A	850V 29A	10min.	--	230V <1A	850V <1A	Inverter disconnected from grid immediately. Error message:" VbusRmsUnbalance". No damaged.No hazard.
R564	Open	230V 35A	850V 29A	10min.	--	230V <1A	850V <1A	Inverter disconnected from grid immediately. Error message:" VbusRmsUnbalance". No damaged.No hazard.
C62	Short	230V 35A	850V 29A	10min.	--	230V 35A	850V 29A	Inverter operated normally. No damaged.No hazard.
R601	Open	230V 35A	850V 29A	10min.	--	230V <1A	850V <1A	Inverter disconnected from grid immediately. Error message:" GridUVP". No damaged.No hazard.
R602	Short	230V 35A	850V 29A	10min.	--	230V 35A	850V 29A	Inverter operated normally. No damaged.No hazard.
R613	Open	230V 35A	850V 29A	10min.	--	230V <1A	850V <1A	Inverter disconnected from grid immediately. Error message:" GridUVP". No damaged.No hazard.



component No.	fault	test condition		test time	fuse No.	fault condition		result
		AC	DC			AC	DC	
R614	Short	230V 35A	850V 29A	10min.	--	230V 35A	850V 29A	Inverter operated normally. No damaged.No hazard.
R189	Open	230V 35A	850V 29A	10min.	--	230V <1A	850V <1A	Inverter disconnected from grid immediately. Error message:" IsoFault". No damaged.No hazard.
R510	Short	230V 35A	850V 29A	10min.	--	230V 35A	850V 29A	Inverter operated normally. No damaged.No hazard.
R799	Open	230V 35A	850V 29A	10min.	--	230V <1A	850V <1A	Inverter disconnected from grid immediately. Error message:" IsoFault". No damaged.No hazard.
R801	Short	230V 35A	850V 29A	10min.	--	230V 35A	850V 29A	Inverter operated normally. No damaged.No hazard.
U13 pin82	Open	230V 35A	850V 29A	10min.	--	230V <1A	850V <1A	Inverter disconnected from grid immediately. Error message:" BluetoothFault". No damaged.No hazard.
U13 pin95	Open	230V 35A	850V 29A	10min.	--	230V <1A	850V <1A	Inverter disconnected from grid immediately. Error message:" BluetoothFault". No damaged.No hazard.
See technical documentation.								



7.3.7	TABLE: clearance and creepage distance measurements					P
clearance cl and creepage distance dcr at / of:	Up (V)	U r.m.s (V)	required cl (mm)	cl (mm)	required dcr (mm)	dcr (mm)
PV circuit and earthed enclosure(BI)	--	1100Vdc	3.1	11.2	3.1	11.2
AC circuit and earthed enclosure(BI)	--	1100Vdc	3.1	11.2	3.1	11.2
Main power board: AC circuit go through Y capacitor C134, C151 to earth on PCB (BI)	--	1100Vdc	3.1	7.3	3.1	7.3
Main power board: AC circuit go through optocoupler U11 to earth on PCB (BI)	--	1100Vdc	3.1	7.3	3.1	7.3
AC output circuit L and N on PCB (BI)	--	1100Vdc	4.0	5.5	4.0	5.5
Main power board: PV circuit go through Y capacitor CY21, CY1, CY16, CY3 to earth on PCB (BI)	--	1100Vdc	4.0	7.4	5.6	7.4
Power board: PV circuit go through isolation transformer TX3 to communication ports (RI)	--	1100Vdc	6.5	10.1	6.5	10.1
Main power board: PV circuit go through Y capacitor CY14, CY15 to communication ports (RI)	--	1100Vdc	6.5	16.0	6.5	16.0
Power board: PV circuit go through optocoupler U20, U21, U18, U22, U10, U9 to communication ports (RI)	--	1100Vdc	6.5	8.3	6.5	8.3
Live parts IGBT and earthed screws (BI)	--	1100Vdc	4.0	7.0	5.6	7.0
Main power board: Relay (RL3, RL4, RL5, RL6) two polarity on PCB board (BI)	--	230Vac	4.0	7.2	4.0	7.2
Transformer(T1) primary parts to secondary part	--	1100Vdc	6.5	9.0	6.5	9.0
Transformer(T1) Iron-core to secondary part	--	1100Vdc	6.5	11.8	6.5	11.8
Supplementary information: RI: Reinforced insulation, DI: double insulation, BI: basic insulation, SI: supplementary insulation The double side PCB layout is considered and evaluated.						



7.3.7.8.3.2 TABLE: distance through insulation measurement to 7.3.7.8.3.3				P
distance through insulation distance at/of:	U r.m.s. (V)	test voltage (Vdc)	required di (mm)	di (mm)
Insulation sheet	1100	4665	--	2.0
Photo coupler (certified)*	1100	5090	0.4	0.4
Insulation tube(fixed IGBT)	1100	5090	0.4	1.3

* Approved components.

7.5 TABLE: electric strength measurements, impulse voltage test and partial discharge test				P
test voltage applied between:	test voltage (Vdc)	impulse withstand voltage (V)	partial discharge extinction voltage (V)	result
DC input terminal to earthed enclosure	2797	4000	—	Pass
DC input terminal to communication port	5494	6000	—	Pass
AC output terminal to earthed enclosure	2120	4000	—	Pass
AC output terminal to communication port	4240	6000	—	Pass
Insulation sheet	2797	4000	—	Pass
Two layers of insulation tape	5494	6000	—	Pass
Relay pin 3 to pin 4	2797	4000	—	Pass
DC input terminal to earthed enclosure	2797	4000	—	Pass



14 TABLE: list of critical components					P
Component	Manufacturer/ trademark	Type/model	Value / rating	Standard	Approval/ Reference
Whole unit					
Metal Enclosure	All	All accepted	Min. thickness : 1.5mm	--	--
Plastic cover (LCD screen)	MACDERMID AUTOTYPE LTD	Autotex XE(f2)	105°C, V-0, min. 0.2mm thickness	UL 94 UL 746C	UL
DC connector	Stäubli Electrical Connectors AG	PV-KST4/xy-UR PV-KBT4/xy-UR	1000Vdc, 39A, Max. 85°C, IP68	IEC 62852:2014	TUV R60127190
Or	Dongguan Vaconn Electronic Technology Co.,Ltd.	VP-D4a-bcdef (DEVALAN)	1000Vdc, 39A, Max. 85°C, IP68	IEC 62852:2014 EN 62852:2014	TUV R50396796
Internal wiring(DC switch-The mainboard PV line)	All	All accepted	Min.10AWG, 2000V,105°C	UL11627	UL
Internal wiring(PV-DC)	All	All accepted	Min,12AWG,20 00V,105°C	UL11627	UL
Internal wiring (AC-out)	All	All accepted	Min,10AWG,10 00V,105°C	UL10269	UL
Earthing wire	All	All accepted	Min.10AWG, yellow-green, 105°C	UL10269	UL
DC Switch	Santon Switchgear Ltd	XBHP+3410/2- D	1000V/30A, 600V/60A, Max.85°C	EN 60947- 3:2009 EN60947- 3:2009/A1:2012 /C1:2013 EN 60947- 3:2009/A2:2015	DEKRA 71-107727
		XBHP+3419- AAX/6	1000V/30A, 600V/50A, Max.85°C		
Or	ProJoy Electric Co., Ltd.	PEDS150R-HM 55-4	1000V/25A,4P, Max.85°C	EN 60947-3:200 9+Al+A2	TUV R 50389807
Or	Shanghai Liangxin Electrical Co., Ltd	NDG3V-32/20/4 /1/02/M/1100	1100V/20A, 600V/30A,4P, Max.85°C	IEC 60947-1 IEC 60947-3	TUV B 083574 02 50 Rev.03



**BUREAU
VERITAS**

Test Report No: LD200511N080

14 TABLE: list of critical components					P
Component	Manufacturer/ trademark	Type/model	Value / rating	Standard	Approval/ Reference
Inductor	ANHUI ECRIEMAG TECHNOLOGY CO., LTD.	Alloy power core	BOOST: 2*475µH INV: 3*244µH	--	--
Or	Huizhou baohui electro-tech ltd				
Or	CHINA AMORPHOUS TECHNOLOGY CO.,LTD				
Or	Shenzhen jingquanhua electronics co., ltd				
Or	ShenZhen Highlight Electronic Co., LTD				
-Lead wire	All	All accepted	10AWG,1000V, 105°C, VW-1	UL10269	UL
DC Fans (internal)	Dongguan PROTECHNIC ELECTRIC CO., LTD.	MGT9212UB- R25	12V, 0.54A, Max.70°C	EN60950-1: 2006/A2:2013	TUV B 031023 0131 Rev.02
Or	ASAI VITAL COMPONENTS CO LTD	DS09225B12U	12V, 0.56A, Max.70°C	EN55032:2015 EN 55024:2010/A1: 2015	TUV E8A 17 09 25730 775
DC Fans (External)	NMB Technologies Corporation	08025KA-12N- GT-01	12V,0.3A, Max.70°C	EN 62368- 1:2014/A11:201 7 IEC 62368- 1:2014 EN 62368- 1:2014	VDE
Or		08025VE-12M- CTD	12V,0.3A, Max.70°C	EN 62368- 1:2014/A11:201 7 IEC 62368- 1:2014 EN 62368- 1:2014	VDE
Heat shrinkable tube	Shenzhen QFR Electronics Co., Ltd	QFR-H-600	125°C, VW-1, 600V	UL 224	UL
	SHENZHEN W OER HEAT-SH RINKABLE MAT ERIAL CO.,LTD	RSFR-H	125°C, VW-1, 600V	UL 224	UL

**Bureau Veritas Shenzhen Co., Ltd.
Dongguan Branch**

No. 96, Guantai Road (Houjie Section), Houjie
Town, Dongguan City, Guangdong Province,
523942, People's Republic of China
Page 90 of 109

Tel: +86 769 89982098
Fax: +86 769 85991080
Email: customerservice.dg@bureauveritas.com
TESTREPORT IEC 62109-2 VER.5



14 TABLE: list of critical components					P
Component	Manufacturer/ trademark	Type/model	Value / rating	Standard	Approval/ Reference
	Shenzhen QFR Electronics Co., Ltd	QFR-H-600	125°C, VW-1, 600V	UL 224	UL
AC output terminal Block	Shenzhen Connection Electronic Co Ltd	DRTB16-05-RS T	65A/600Vac, Max. 105°C	UL1059	UL
All PCB	All	All accepted	Min.130°C, min. V-0, CTI≥175	UL 796	UL
Power Board					
Input Y-Cap (CY1, CY2, CY3, CY4, CY5, CY6, CY7, CY10, CY14, CY15)	Samwha Capacitor Co., Ltd	SC	Y1, 4.7nF, 400Vac, Max.85°C	EN 60384-14:2013/A1:2016; EN 60384-14:2013-08	VDE
Or	WALSIN TECHNOLOGY CORP	AH	Y1, 4.7nF, 400Vac, Max. 85°C	EN 60384-14:2013/A1:2016; EN 60384-14:2013-08	VDE
Input Y-Cap (CY8, CY9, CY11, CY12, CY13, CY16, CY21)	Samwha Capacitor Co., Ltd	SC	100pF, 400Vac, Max. 85°C	EN 60384-14:2013/A1:2016; EN 60384-14:2013-08	VDE
Or	WALSIN TECHNOLOGY CORP	AH	100pF, 400Vac, Max. 85°C	EN 60384-14:2013/A1:2016; EN 60384-14:2013-08	VDE
Input Current transformer(LP1)	HUIZHOU BAOHUI ELECTRONICS TECHNOLOGY CO.,LTD	115-20-007A	Class B (130°C)	--	--
--Winding	All	All accepted	130°C	UL 1446	UL
Input Varistor (MOV1, MOV2, MOV3, MOV4,)	TDK (ZHUHAI FTZ) CO., LTD	S20K510 Or SNF20K510E2 S5	510VAC, I _{max} : 10kA, Max.: 125°C	IEC 60151-1 IEC 60151-2 IEC 60151-2/AMD1 IEC 61051-2-2	VDE



14 TABLE: list of critical components					P
Component	Manufacturer/ trademark	Type/model	Value / rating	Standard	Approval/ Reference
Or	DongGuan LittelfuseElectro nics Co., Ltd.	LA Series V20E510P	510Vac, Imax: 10kA, Max.: 125°C	CECC 42201- 006, Issue 3, 2004-10 IEC 60950- 1:2013-05 IEC 61051- 1:1992 IEC 61051- 2(ed.1);am1:20 09-05 IEC 61051- 2:1992 IEC 61051- 1:2007	VDE
Input DC SPD (F4)	Sichuan Zhongguang Lightning Protection Technologies Co., Ltd.	ZGGS20- 500PVh1c1	385Vac/500Vdc Imax:10kA, Max. 85°C	IEC 61643- 11:2011 EN 61643- 11:2012	TUV R 50342738
Or	SHENZHEN HAIPENGXIN ELECTRONICS CO.,LTD.	PV20K-500	385Vac/500Vdc Imax:10kA, Max. 85°C	EN 61643- 11:2012	TUV R 50316472
Input Line filter (L1)	HUIZHOU BAOHUI ELECTRONICS TECHNOLOGY CO.,LTD	115-20-028A	0.7mH, Max. 130°C	----	----
--Winding	All	All accepted	180°C	UL 1446	UL
Input Electronics capacitor(CTF1, CTF2,CTF3)	Xiamen Faratronic Co.,Ltd.	C3D1M205KB0 0382	2μF,1100Vdc, Max.105°C	--	--
Or	Hua Jung Components Co., Ltd	DMJ-PS Series	2μF,1100Vdc, Max.105°C	--	--
Input Electronics capacitor(C10, C16)	Xiamen Faratronic Co.,Ltd.	C3D1M156KF1 2382	15μF, 1100Vdc, Max. 105°C	--	--
Or	TDK	B32776S0156K 519	15μF, 1100Vdc, Max. 105°C	--	--
Or	Hua Jung Components Co., Ltd	DMJ-PS Series	15μF, 1100Vdc, Max. 105°C	--	--



14 TABLE: list of critical components					P
Component	Manufacturer/ trademark	Type/model	Value / rating	Standard	Approval/ Reference
Input Current sensor (HCT1,HCT4)	Sinomags Technology Co., Ltd	STK-20HD/P2	IPN: 20A Vc: 5V Icc: 5mA Max.: 105°C	--	--
Current sensor (HCT2、 HCT3)	Allegro MicroSystems, LLC	ACS724KMATR -30AB-T	Di ≥ 0.4mm Internall di ≥ 7.0mm External di ≥ 7.62mm, AC 8000V, reinforced Insulation 115°C	UL 60950- 1:2007/A2:2014 EN 60950- 1:2006/A2:2013	TUV U8V 16 03 54214 040
Input Relay (RY1, RY2)	Xiamen Hongfa Electroacoustic Co. Ltd.	HFD3/5	2A, 250Vac, 5Vdc, Max.85°C	IEC 61810-1 VDE 0435	VDE
Boost IGBT(Q4, Q12, Q50, Q51)	Fairchild	FGY40T120SM D	1200V, 40A, Max.175°C	--	--
DOr	Infineon	IKQ40N120CH3	1200V,40A, Max.175°C	--	--
Bus Electronics capacitor(CTF4, CTF5, CTF6, CTF7, CTF8, CTF9)	Xiamen Faratronic Co., Ltd.	C3D	110μF, 550V, Max. 105°C	EN 61071:2007 IEC 61071:2007 IEC 61881- 1:2010 EN 61881- 1:2011	TUV R 50266108
Or	Wuxi CRE New Energy Technology CO.,Ltd	DMJ-PS DPS1170550K4 22101	110μF, 550V, Max. 105°C	--	--
Or	Hua Jung Components Co., Ltd	EPB- 117K0550DB15 23-FF	110μF, 550V, Max. 105°C	--	--
INV IGBT(Q5,Q6,Q7 ,Q8,Q9,Q10)	Fairchild	FGA40T65SHD	40A, 650V, Max. 175°C	--	--
or	Infineon	IKW40N65H5 Or IKW40N65ES5	40A, 650V, Max. 175°C	--	--
INV IGBT(Q1,Q2,Q3 ,Q11,Q12,Q13)	On-Semi	FGY75T120SQ DN	75A, 1200V, Max. 175°C	--	--
Or	Infineon	IKQ75N120CH3	75A, 1200V, Max. 175°C	--	--



14 TABLE: list of critical components					P
Component	Manufacturer/ trademark	Type/model	Value / rating	Standard	Approval/ Reference
Or ^a	On-Semi	FGY40T120SM D	40A, 1200V, TP-247, Max.175°C	--	--
Or ^a	Infineon	IKQ40N120CH3	40A, 1200V, TP-247, Max.175°C	--	--
Power Diode (D1, D2)	CREE	C4D20120D	1200V, 32A, 175°C	--	--
Or	On-Semi	FFSH30120AD N-F155	1200V, 30A, 175°C	--	--
Output Electronics capacitor(C35, C41, C47)	Xiamen Faratronic Co., Ltd.	C6AR8805KF20 382	8μF, 380Vac, Max. 105°C	--	--
Or	TDK	Z905927714s51 2	8μF, 380Vac, Max. 105°C	--	--
Output Relay for all models except (RL1, RL2, RL3, RL4, RL5, RL6)	Xiamen Hongfa Electroacoustic Co. Ltd.	HF161F- 40W/12- HTF(967)	40A, 277Vac, 12Vdc, Max. 105°C	IEC 61810- 1:2015 EN 61810- 1:2015	TUV R 50475730
Or	ZETTLER	AZSR143-1AE- 12D	40A, 277Vac, 12Vdc, Max. 105°C	IEC 61810-1	TUV B 088793 0015 Rev.00
Or ^a	Xiamen Hongfa Electroacoustic Co. Ltd.	HF161F-W/12- HT(477)	26A, 277Vac, 12Vdc, Max. 85°C	EN61810- 1:2015	VDE
Or ^a	ZETTLER	AZSR131-1AE- 12D	31A, 277Vac, 12Vdc, Max. 85°C	IEC 61810-1	TUV B 088793 0005 Rev.01
Output GFCI Module(LP2)	HUIZHOU BAOHUI ELECTRONICS TECHNOLOGY CO.,LTD	SH-T009	Class B (130°C)	--	--
Or	CHINA AMORPHOUS TECHNOLOGY CO., LTD	CA01-12054			
- Winding	All	All accepted	155°C	UL 1446	UL



14 TABLE: list of critical components					P
Component	Manufacturer/ trademark	Type/model	Value / rating	Standard	Approval/ Reference
Output Y-Cap (C59, C60, C61,C63,CY24, CY25, CY26,CY17, CY18, CY19, CY22, CY27, CY28)	SAMWHA CAPACITOR CO LTD	SD	Y1, 4.7nF, 400Vac, Max. 85°C	EN 60384- 14:2013/A1:201 6 IEC 60384- 14:2013 IEC 60384- 14:2013/AMD1: 2016; EN 60384- 14:2013-08	VDE
Or	WALSIN TECHNOLOGY CORP	AH	Y1, 4.7nF, 500Vac, Max. 85°C	EN 60384- 14:2013/A1:201 6 IEC 60384- 14:2013 IEC 60384- 14:2013/AMD1: 2016; EN 60384- 14:2013-08	VDE
Output Y-Cap(C58, C62, C64, C69)	Xiamen faratronic Co., Ltd	MKP63	Y2, 33nF, 300Vac, Max. 110°C	EN 60384- 14:2013+A1 UL60384- 14:2009	ENEC:SE/0366- 2D
Output Line filter(L2)	HUIZHOU BAOHUI ELECTRONICS TECHNOLOGY CO.,LTD	115-20-030A	13μH, Max.130°C	--	--
- Winding	All	3.0*3.7mm	200°C	UL 758	UL
Or	All	All accepted	Short wiring, Min2.0*3.8mm, copper, 150°C	--	--
--Tape	JINGJIANG YAHUA PRESSURE SENSITIVE GLUE CO LTD	PF-301	180°C	UL 510	UL
Output Current sensor (HCT5, HCT6, HCT7)	 LEM	CASR 25-NP	IPN:25A; Vc: 5V. Max.: 85°C	--	--
Or	VAC	T60404-N4646- X661	IPN:25A; Vc: 5V. Max. 85°C	--	--



**BUREAU
VERITAS**

Test Report No: LD200511N080

14 TABLE: list of critical components					P
Component	Manufacturer/ trademark	Type/model	Value / rating	Standard	Approval/ Reference
Output Varistor (MOV5, MOV6, MOV7, MOV8)	TDK	S20K510 Or SNF20K510E2 S5	510Vac, Imax: 10kA, Max.:125°C	IEC 60151-1 IEC 60151-2 IEC 60151- 2/AMD1 IEC 61051-2-2	VDE
Or	Littelfuse	LA Series V20E510P	510Vac, Imax: 10kA, Max. 125°C	CECC 42201- 006, Issue 3, 2004-10 IEC 60950- 1:2013-05 IEC 61051- 1:1992 IEC 61051- 2(ed.1);am1:20 09-05 IEC 61051- 2:1992 IEC 61051- 1:2007	VDE
Output Gas tube (GAS1)	Bencent electronics ltd	B8G1500M	380V, 10kA, Max.: 90°C	UL1449	UL
Output Thermal fuse(F5, F6, F7)	AUPO ELECTRONICS LTD	A2	2A, 250V, Max. 203°C	UL 60691	UL
Output Electronics capacitor(C65, C66, C67, C415)	XIAMEN FARATRONIC CO.,LTD	C46H2474KB3 C450	X1, 0.47uF, 500Vac, Max. 110°C X1, 0.56uF, 500Vac, Max. 110°C X1, 0.68uF, 500Vac, Max. 110°C	--	--
Driver Optocoupler (UV1, UV2, UV3, UV4, UV5, UV6, UV7, UV8, UV9, UV10, UV11, UV12, UV13, UV14)	Texas Instruments Deutschland GmbH	UCC23513DWY R	Max.130°C	DIN V VDE V 0884-11:2017	VDE
Or	Fairchild Semiconductor Pte Ltd	FOD8342T	Max.130°C	DIN EN 60747-5- 5 (0884-5):2015- 11; EN 60747-5- 5:2011; A1:2015	VDE



14 TABLE: list of critical components					P
Component	Manufacturer/ trademark	Type/model	Value / rating	Standard	Approval/ Reference
Opt coupler (U18, U21, U20, U22, U11)	Lite-On Technology Corporation	LTV-816 S2	Di ≥ 0.4mm External Cr. And Cl. ≥ 8.0mm, AC 8000V, reinforced Insulation 115°C	IEC 60747-5- 5:2007 IEC 60747-5- 5:2007/AMD1:2 013 DIN EN 60747- 5-5 (0884- 5):2015-11; EN 60747-5- 5:2011; A1:2015	VDE
Auxiliary_power transformer(T1)	HUIZHOU BAOHUI ELECTRONICS TECHNOLOGY CO.,LTD	115-20-005A	Class B, Max. 130°C	--	--
- Winding	All	All accepted	130°C	UL 1446	UL
- Bobbin	SUMITOMO BAKELITE CO LTD	PM-9820, PM-9030	V-0, min. thickness: 0.75mm, 150°C	UL 94	UL
Or	CHANG CHUN PLASTICS CO.,LTD	T375J	V-0, min. thickness: 0.75mm, 150°C	UL 94	UL
--Tape	JINGJIANG YAHUA PRESSURE SENSITIVE GLUE CO LTD	CT-	130°C	UL 510	UL
- Margin Tape	Jingjiang Yahua Pressure Sensitive Glue Co Ltd	WF-	3.0mm, 130°C	UL 510	UL
- Tube	SHENZHEN WOER HEAT- SHRINKABLEM ATERIAL CO.,LTD	WF(PTFE)	600V, Max. 200°C	UL224	UL
Auxiliary_power transformer(T2)	HUIZHOU BAOHUI ELECTRONICS TECHNOLOGY CO.,LTD	115-19-067C	Class B, Max. 130°C	--	--
- Winding	All	All accepted	130°C	UL 1446	UL
- Bobbin	SUMITOMO BAKELITE CO LTD	PM-9820, PM-9030	V-0, min. thickness: 0.75mm, 150°C	UL 94	UL



**BUREAU
VERITAS**

Test Report No: LD200511N080

14 TABLE: list of critical components					P
Component	Manufacturer/ trademark	Type/model	Value / rating	Standard	Approval/ Reference
Or	CHANG CHUN PLASTICS CO.,LTD	T375J	V-0, min. thickness: 0.75mm, 150°C	UL 94	UL
--Tape	JINGJIANG YAHUA PRESSURE SENSITIVE GLUE CO LTD	CT-	130°C	UL 510	UL
- Margin Tape	Jingjiang Yahua Pressure Sensitive Glue Co Ltd	WF-	1.5mm,130°C	UL 510	UL
- Tube	SHENZHEN WOER HEAT- SHRINKABLEM ATERIAL CO.,LTD	WF(PTFE)	600V, Max. 200°C	UL224	UL
Auxiliary_power Current transformer(T3, T4)	Shenzhen Spit Electronics Co. LTD	SPT-08E0313- CT	Max. 130°C	--	--
- Winding	All	All accepted	155°C	UL 1446	UL
- Bobbin	CHANG CHUN PLASTICS CO LTD	T373J	V-0	UL 94	UL
IGBT Driver Power Fuse(FC1)	Littelfuse Inc.	1812L110/33	1.1A, 33V, Max. 85°C	EN 60738- 1:2006 EN 60738-1- 1:2008 IEC 60738- 1:2006 IEC 60738-1- 1:2008	TUV R 50119118
IGBT Driver Power transformer(T5)	HUIZHOU BAOHUI ELECTRONICS TECHNOLOGY CO.,LTD	115-20-004A	Max. 130°C	--	--
Digital Isolators (U19)	Texas Instruments Deutschland GmbH	ISO7721DWVR	External Cr. And Cl. \geq 8.0mm, AC 8000V, reinforced Insulation 125°C	DIN VDE V 0884- 11:2017	VDE



**BUREAU
VERITAS**

Test Report No: LD200511N080

14					P
TABLE: list of critical components					
Component	Manufacturer/ trademark	Type/model	Value / rating	Standard	Approval/ Reference
LCD_RS485 Gas tube (GAS2,GAS3)	SHENZHEN BENCENT ELECTRONIC CO LTD	B3D090L-C	90V/5kA, 90°C	UL1449	UL
1)an asterisk indicates a mark which assures the agreed level of surveillance.					
"a" The component is only suitable for SOFAR 15KTLX-G3.					



Appendix 1

4.8.2	TABLE: Array insulation resistance detection for inverters for ungrounded and functionally grounded arrays			P
4.8.2.1	Array insulation resistance detection for inverters for ungrounded arrays			P
DC Voltage below minimum operating voltage (V)	DC Voltage for inverter begin operation (V)	Resistance between ground and PV input terminal (Ω)	Required Insulation resistance $R = (V_{MAX\ PV} / 30mA)$ (Ω)	Result
DC+				
250	250	100K	37K	Error message:" Error:"ID56"(The insulation resistance is too low)" PV inverter does not start-up.
250	480	100K	37K	
250	850	100K	37K	
250	953	100K	37K	
DC-				
250	250	100K	37K	Error message:" Error:"ID56"(The insulation resistance is too low)" PV inverter does not start-up.
250	480	100K	37K	
250	850	100K	37K	
250	953	100K	37K	



Appendix 2

4.8.3.5 Protection by residual current monitoring		P
Test conditions:	Output power: 100% V_{DC} : 850V Frequency: 50Hz Current measuring devices: min. class 0,5 Time measuring devices: <10% of the measured value	

4.8.3.5.2 Test for detection of excessive continuous residual current			P
Fault Current (mA)		Disconnection time (ms)	
Measured Fault Current (mA)	Limit 300mA for output power \leq 30 kVA 10mA per kVA for output power > 30 kVA	Measured Disconnection time (ms)	Limit (ms)
+ PV to N:			
257	300	268	300
262	300	266	300
252	300	272	300
254	300	264	300
252	300	272	300
- PV to N:			
255	300	276	300
254	300	266	300
254	300	274	300
254	300	272	300
254	300	266	300
Note: Comparing test circuit at figure 21. Fault current will rise up to 300mA within 30s. 5 values will be measured and listed.			



4.8.3.5.3 Test for detection of sudden changes in residual current		P
+PV to N		
Limit (mA)	U _N	Limit (s)
	Disconnection time (ms)	
30	220	0.3
30	215	0.3
30	223	0.3
30	232	0.3
30	234	0.3
60	136	0.15
60	128	0.15
60	129	0.15
60	111	0.15
60	113	0.15
150	36	0.04
150	36	0.04
150	29	0.04
150	33	0.04
150	34	0.04
-PV to N		
Limit (mA)	U _N	Limit (s)
	Disconnection time (ms)	
30	241	0.3
30	237	0.3
30	236	0.3
30	231	0.3
30	239	0.3
60	132	0.15
60	133	0.15
60	120	0.15
60	126	0.15
60	117	0.15
150	30	0.04
150	32	0.04
150	34	0.04
150	35	0.04
150	32	0.04

Note:
 The capacitive current is risen until disconnection.
 Test condition: $I_c + 30/60/150\text{mA} \leq I_{c\text{max}}$. R₁ is set that 30/6+0/150ma Flow and switch is closed.



**BUREAU
VERITAS**

Test Report No: LD200511N080

Front view



Rear view





Bottom view (SOFAR 15KTLX-G3, SOFAR 17KTLX-G3)



Bottom view (SOFAR 20KTLX-G3, SOFAR 22KTLX-G3, SOFAR 24KTLX-G3)





**BUREAU
VERITAS**

Test Report No: LD200511N080

Right view



Internal view

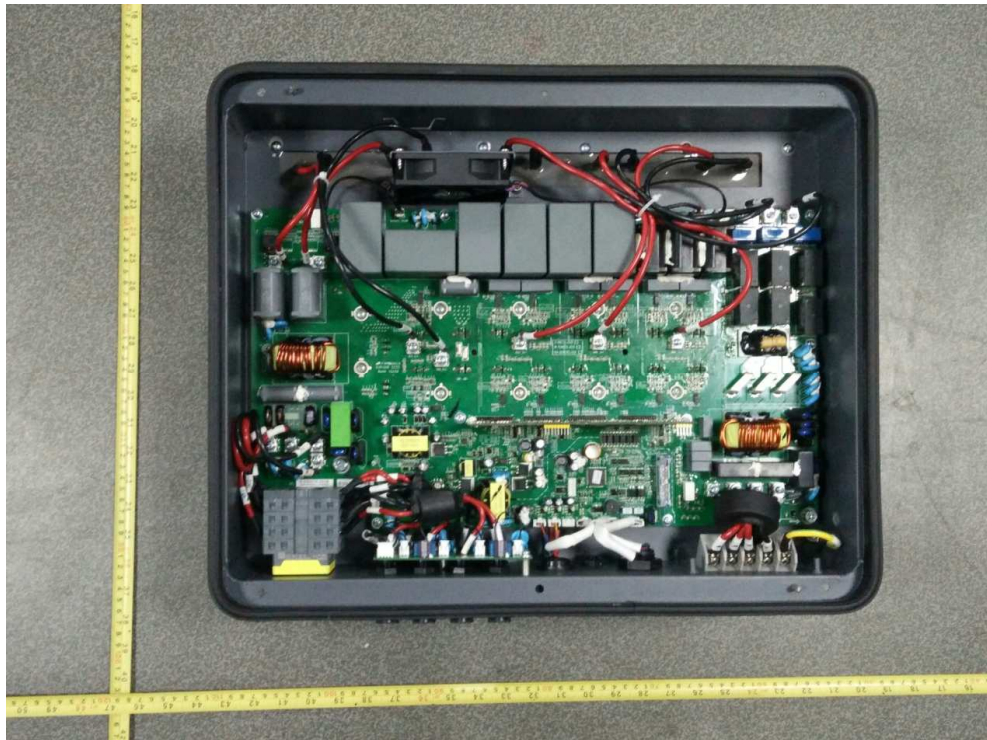



**BUREAU
VERITAS**

Test Report No: LD200511N080

Power board component side view

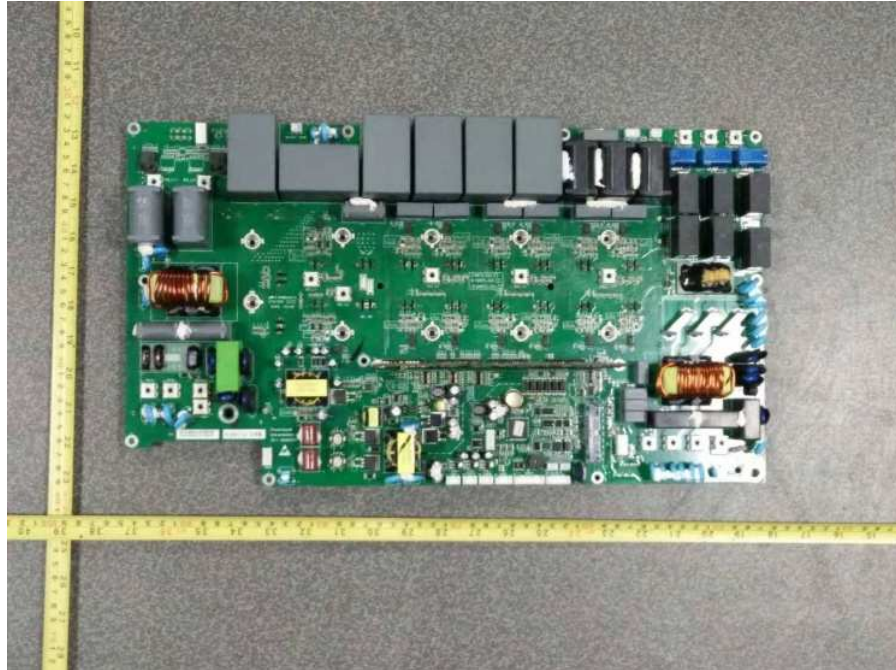

Power board solder side view

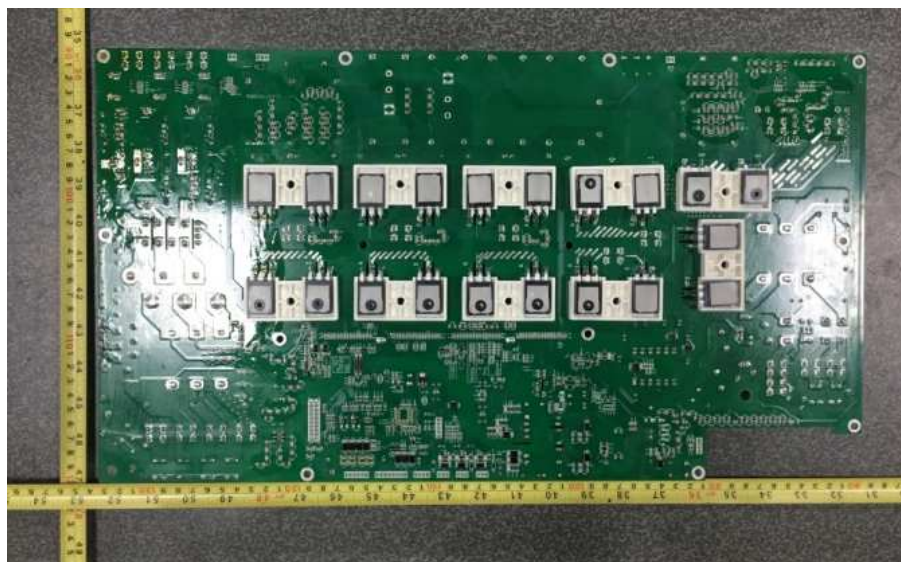



LCD board component side view

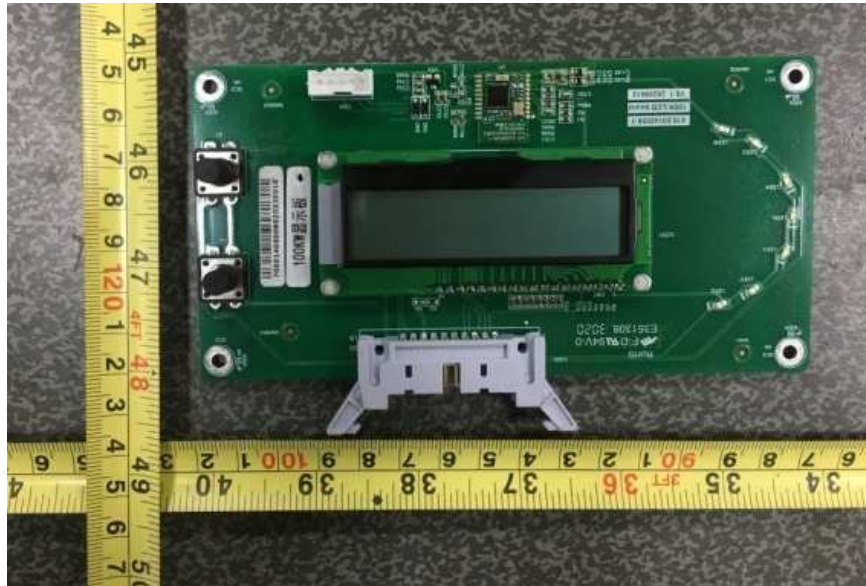

LCD board solder side view

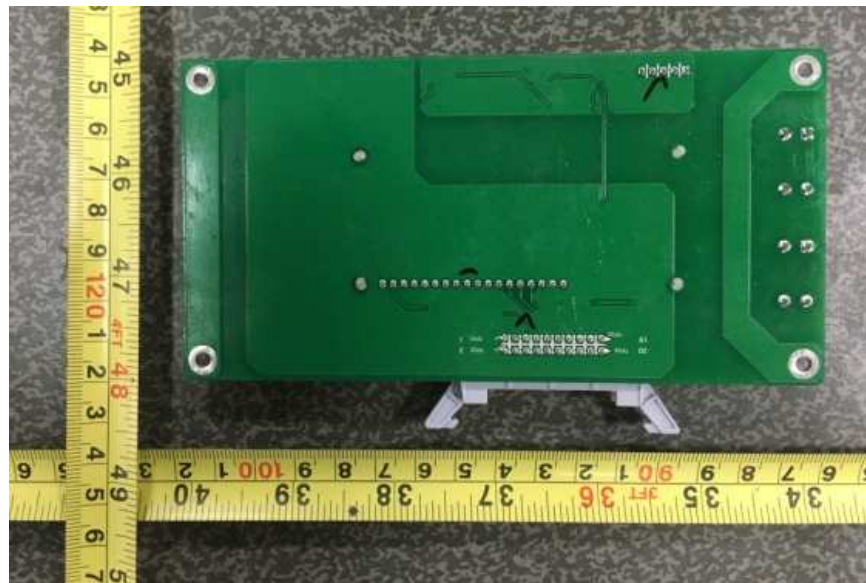



Control board component side view

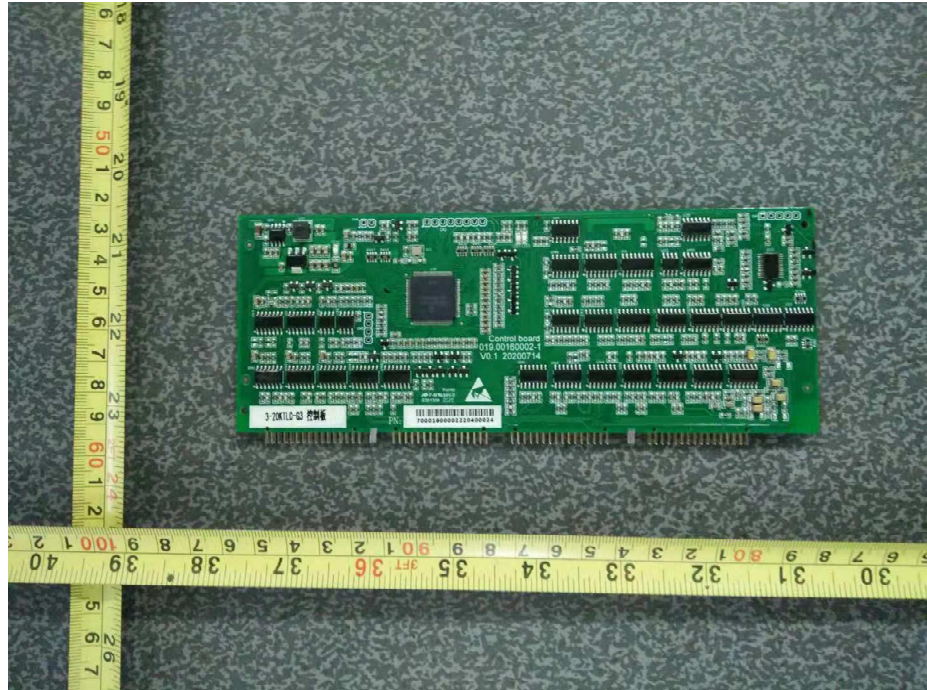

Control power board solder side view

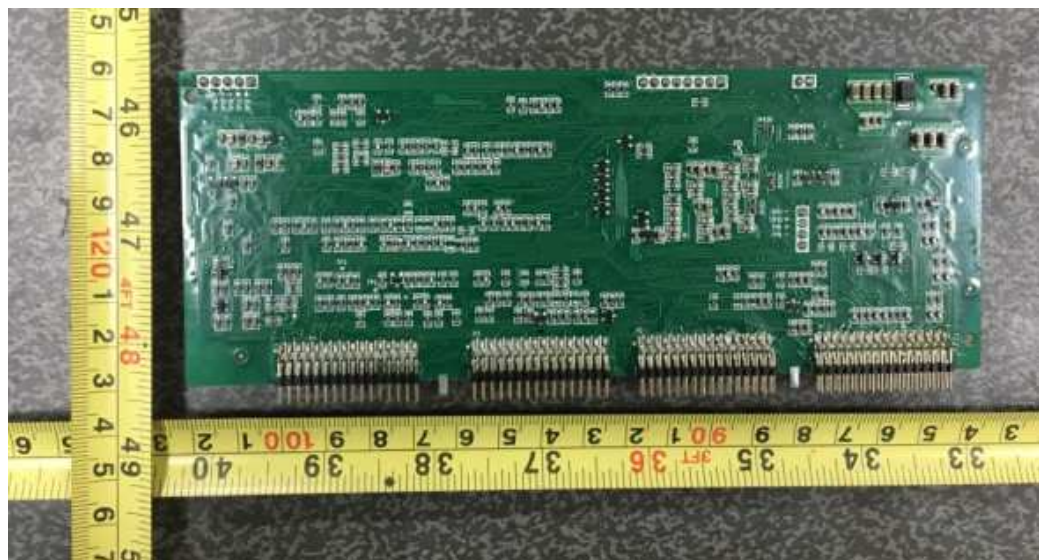



Internal view

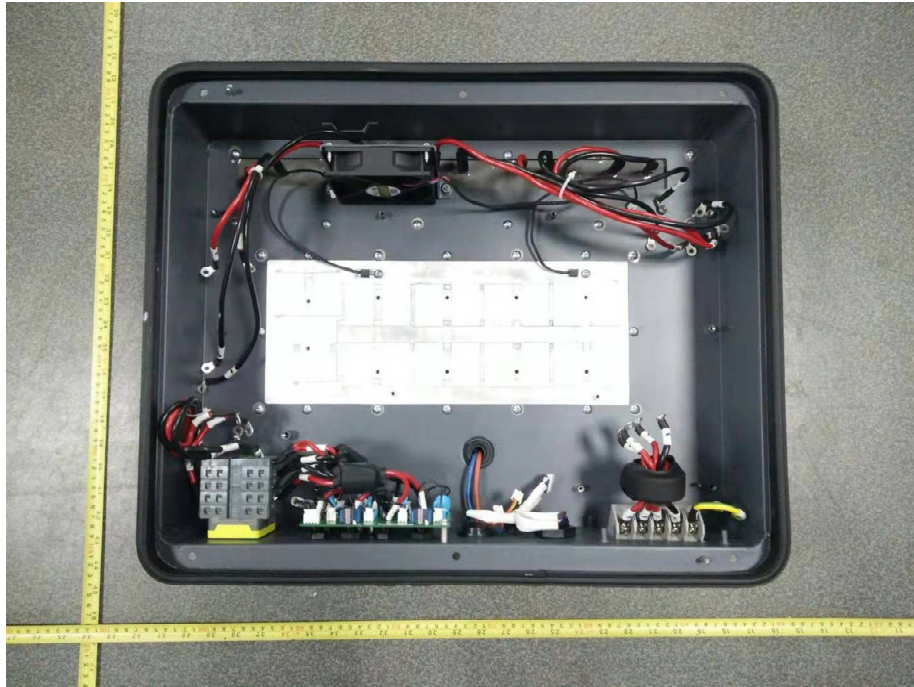

Earthing terminal

