



**BUREAU
VERITAS**

TEST REPORT UTE C15-712-1

**Photovoltaic installations connected to the
public distribution network**

Report reference number PVFR180903N042

Date of issue 2019-03-12

Total number of pages 76

Testing laboratory name **Bureau Veritas Shenzhen Co.,
Ltd. Dongguan Branch**

Address No. 34, Chenwulu Section,
Guantai Rd., Houjie Town,
Dongguan City, Guangdong
523942, China



Applicant's name **Shenzhen SOFAR SOLAR Co., Ltd.**

Address 401, Building 4, AnTongDa Industrial Park, District 68, XingDong
Community, XinAn Street, BaoAn District, Shenzhen, China.

Test specification

Standard UTE C15-712-1:2010-07, UTE C 15-712-1Rec0:2010-09 ,
UTE C 15-712-1Rec1:2012-02, UTE C15-712-1:2013-07

DIN V VDE V 0126-1-1/A1 VFR2014

(Protections des installations de production raccordées Identification au
réseau public de distribution, ERDF-NOI-RES_13E, Version 6,
11/07/2016)

With deviations for French Islands according protection de Découplage
pour le Raccordement d'une production décentralisée en HTA et en BT
dans les zones non interconnectées, référentiel technique – SEI REF
04, V6

With deviations for French Islands according contrat de raccordement,
d'accès et d'exploitation (CRAE) pour une installation de production
photovoltaïque raccordée au réseau public d'électricité



Certificate **Certificate of compliance**

Test report form number TEST REPORT UTE-C15-712-1 VER.2

Master TRF Bureau Veritas Consumer Products Services Germany GmbH

This report is governed by, and incorporates by reference, CPS Conditions of Service as posted at the date of issuance of this report at <http://www.bureauveritas.com/home/about-us/our-business/cps/about-us/terms-conditions>; and is intended for your exclusive use. Any copying or replication of this report to or for any other person or entity, or use of our name or trademark, is permitted only with our prior written permission. This report sets forth our findings solely with respect to the test samples identified herein. The results set forth in this report are not indicative or representative of the quality or characteristics of the lot from which a test sample was taken or any similar or identical product unless specifically and expressly noted. Our report includes all of the tests requested by you and the results thereof based upon the information that you provided to us. Measurement uncertainty is only provided upon request for accredited tests. You have 60 days from date of issuance of this report to notify us of any material error or omission caused by our negligence or if you require measurement uncertainty; provided, however, that such notice shall be in writing and shall specifically address the issue you wish to raise. A failure to raise such issue within the prescribed time shall constitute your unqualified acceptance of the completeness of this report, the tests conducted and the correctness of the report contents.

Test item description: Hybrid inverter					
Trademark: 					
Model / Type: HYD 6000-ES, HYD 5000-ES, HYD 4000-ES, HYD 3600-ES, HYD 3000-ES					
Ratings	HYD 6000-ES	HYD 5000-ES	HYD 4000-ES	HYD 3600-ES	HYD 3000-ES
Full load MPP DC voltage range [V] .:	300-520	250-520	200-520	180-520	160-520
Input DC voltage range[V]	90 - 580				
Input DC current [A].....	Max. 12.0 x 2				
Output AC voltage [V]	230, 50Hz				
Output AC current [A]	Max. 27.3	Max.22.8	Max.18.2	Max.16.0	Max. 13.7
Output power [VA]	6000	5000	4000	3680	3000
Output DC voltage range [V]	42-58Vdc				
[Battery charge].....					
Input DC current [A].....	Max.65A				
[Battery charge].....					
Output DC current [A]	Max. 70A				
[Battery discharge].....					
Charge and discharge power[VA].....	Max. 3000				
Output AC voltage [V]	230Vac, 50Hz				
Output AC current [A]	Max.13.2				
Output power [VA]	3000				

Testing Location	Bureau Veritas Shenzhen Co., Ltd. Dongguan Branch
Address	No. 34, Chenwulu Section, Guantai Rd., Houjie Town, Dongguan City, Guangdong 523942, China
Tested by (name and signature).....	Dora Zhang 
Approved by (name and signature).....	James Huang 
Manufacturer's name.....	Shenzhen SOFAR SOLAR Co., Ltd.
Manufacturer's address	401, Building 4, AnTongDa Industrial Park, District 68, XingDong Community, XinAn Street, BaoAn District, Shenzhen, China.
Factory's name.....	Dongguan SOFAR SOLAR Co., Ltd.
Factory's address.....	1F - 6F, Building E, No. 1 JinQi Road, Bihu Industrial Park, Wulian Village, Fenggang Town, Dongguan City.

Document History			
Date	Internal reference	Modification / Change / Status	Revision
2019-03-12	Dora Zhang	Initial report was written	--
Supplementary information:			

Test items particulars	
Equipment mobility.....	: Permanent connection
Operating condition.....	: Continuous
Class of equipment	: Class I
Protection against ingress of water..	: IP65 according to EN 60529
Mass of equipment [kg].....	: Approx. 20,5 kg
Test case verdicts	
Test case does not apply to the test object.....	: N/A
Test item does meet the requirement.....	: P(ass)
Test item does not meet the requirement.....	: F(ail)
Testing	
Date of receipt of test item	: 2018-09-03
Date(s) of performance of test.....	: 2018-09-03 to 2019-02-20
General remarks:	
<p>The test result presented in this report relate only to the object(s) tested. This report must not be reproduced in part or in full without the written approval of the issuing testing laboratory.</p> <p>"(see Annex #)" refers to additional information appended to the report. "(see appended table)" refers to a table appended to the report.</p> <p>Throughout this report a comma is used as the decimal separator.</p>	
This Test Report consists of the following documents:	
<ol style="list-style-type: none"> 1. Test Results 2. Annex No. 1 – DIN V VDE V 0126-1-1:2006-02/A1:2012-02 Test Report 3. Annex No. 2 – Pictures of the unit 4. Annex No. 3 – Test equipment list 	

Copy of marking plate(Representative):

SOFAR SOLAR Hybrid Inverter	
Model No:	HYD 3000-ES
Max.DC Input Voltage	600V
Operating MPPT Voltage Range	90V~580V
MAX.PV Isc	2x15A
Battery Type	Lead-acid,Lithium-ion
Battery Voltage Range	42~58V
Max.Charging Current	65A
Max.Discharging Current	70A
Max.Charging&Discharging Power	3000VA
Nominal Grid Voltage	230Vac
Nominal Output Voltage	230Vac
Max.Output Current	13.7A
Nominal Grid Frequency	50/60Hz
Power Factor	1(adjustable+/-0.8)
Nominal Output Power	3000VA
Backup Rated Current	13.2A
Backup Rated Apparent Power	3000VA
Ingress Protection	IP65
Operating Temperature Range	-25~+60°C
Protective Class	Class I
Manufacturer : Shenzhen SOFAR SOLAR Co.,Ltd. Address : 401, Building 4, AnTongDa Industrial Park, District 68, XingDong Community,XinAn Street, BaoAn District, Shenzhen, China SAA183423 VDE0126-1-1,VDE-AR-N4105,G83/2,EN50438, C10/11,ASA4777,RD1699,UTE C15-712-1	
	

SOFAR SOLAR Hybrid Inverter	
Model No:	HYD 3600-ES
Max.DC Input Voltage	600V
Operating MPPT Voltage Range	90V~580V
MAX.PV Isc	2x15A
Battery Type	Lead-acid,Lithium-ion
Battery Voltage Range	42~58V
Max.Charging Current	65A
Max.Discharging Current	70A
Max.Charging&Discharging Power	3000VA
Nominal Grid Voltage	230Vac
Nominal Output Voltage	230Vac
Max.Output Current	16A
Nominal Grid Frequency	50/60Hz
Power Factor	1(adjustable+/-0.8)
Nominal Output Power	3680VA
Backup Rated Current	13.2A
Backup Rated Apparent Power	3000VA
Ingress Protection	IP65
Operating Temperature Range	-25~+60°C
Protective Class	Class I
Manufacturer : Shenzhen SOFAR SOLAR Co.,Ltd. Address : 401, Building 4, AnTongDa Industrial Park, District 68, XingDong Community,XinAn Street, BaoAn District, Shenzhen, China SAA183423 VDE0126-1-1,VDE-AR-N4105,G83/2,EN50438, C10/11,ASA4777,RD1699,UTE C15-712-1	
	

SOFAR SOLAR Hybrid Inverter	
Model No:	HYD 4000-ES
Max.DC Input Voltage	600V
Operating MPPT Voltage Range	90V~580V
MAX.PV Isc	2x15A
Battery Type	Lead-acid,Lithium-ion
Battery Voltage Range	42~58V
Max.Charging Current	65A
Max.Discharging Current	70A
Max.Charging&Discharging Power	3000VA
Nominal Grid Voltage	230Vac
Nominal Output Voltage	230Vac
Max.Output Current	18.2A
Nominal Grid Frequency	50/60Hz
Power Factor	1(adjustable+/-0.8)
Nominal Output Power	4000VA
Backup Rated Current	13.2A
Backup Rated Apparent Power	3000VA
Ingress Protection	IP65
Operating Temperature Range	-25~+60°C
Protective Class	Class I
Manufacturer : Shenzhen SOFAR SOLAR Co.,Ltd. Address : 401, Building 4, AnTongDa Industrial Park, District 68, XingDong Community,XinAn Street, BaoAn District, Shenzhen, China SAA183423 VDE0126-1-1,VDE-AR-N4105,G83/2,EN50438, C10/11,ASA4777,RD1699,UTE C15-712-1	
	

SOFAR SOLAR Hybrid Inverter	
Model No:	HYD 5000-ES
Max.DC Input Voltage	600V
Operating MPPT Voltage Range	90V~580V
MAX.PV Isc	2x15A
Battery Type	Lead-acid,Lithium-ion
Battery Voltage Range	42~58V
Max.Charging Current	65A
Max.Discharging Current	70A
Max.Charging&Discharging Power	3000VA
Nominal Grid Voltage	230Vac
Nominal Output Voltage	230Vac
Max.Output Current	22.8A
Nominal Grid Frequency	50/60Hz
Power Factor	1(adjustable+/-0.8)
Nominal Output Power	5000VA
Backup Rated Current	13.2A
Backup Rated Apparent Power	3000VA
Ingress Protection	IP65
Operating Temperature Range	-25~+60°C
Protective Class	Class I
Manufacturer : Shenzhen SOFAR SOLAR Co.,Ltd. Address : 401, Building 4, AnTongDa Industrial Park, District 68, XingDong Community,XinAn Street, BaoAn District, Shenzhen, China SAA183423 VDE0126-1-1,VDE-AR-N4105,G83/2,EN50438, C10/11,ASA4777,RD1699,UTE C15-712-1	
	

SOFAR SOLAR	
Hybrid Inverter	
Model No: HYD 6000-ES	
Max.DC Input Voltage	600V
Operating MPPT Voltage Range	90V~580V
MAX.PV Isc	2x15A
Battery Type	Lead-acid,Lithium-ion
Battery Voltage Range	42~58V
Max.Charging Current	65A
Max.Discharging Current	70A
Max.Charging&Discharging Power	3000VA
Nominal Grid Voltage	230Vac
Nominal Output Voltage	230Vac
Max.Output Current	27.3A
Nominal Grid Frequency	50/60Hz
Power Factor	1(adjustable+/-0.8)
Nominal Output Power	6000VA
Backup Rated Current	13.2A
Backup Rated Apparent Power	3000VA
Ingress Protection	IP65
Operating Temperature Range	-25~+60°C
Protective Class	Class I
Manufacturer : Shenzhen SOFAR SOLAR Co.,Ltd.	
Address : 401, Building 4, AnTongDa Industrial Park,	
District 68, XingDong Community,XinAn Street,	
BaoAn District, Shenzhen, China	
SAA 183423	
VDE0126-1-1,VDE-AR-N4105,G83/2,EN 50438,	
C10/11,ASA4777,RD1699,UTE C15-712-1	
	

Required markings on the inverter



Attention
Présence de deux sources
de tension
-Réseau de distribution
-Panneaux photovoltaïques



**Isoler les deux sources
avant toute
intervention**

General product information:

The Hybrid inverter is a single-phase type and only one machine is allowed on each line conductor.

The input and output are protected by varistors to Earth. The unit is providing EMC filtering at the PV input and output toward mains. The unit does not provide galvanic separation from input to output (transformerless). The output is switched off redundantly by the high power switching bridge and two relays. This assures that the opening of the output circuit will also operate in case of a single error.

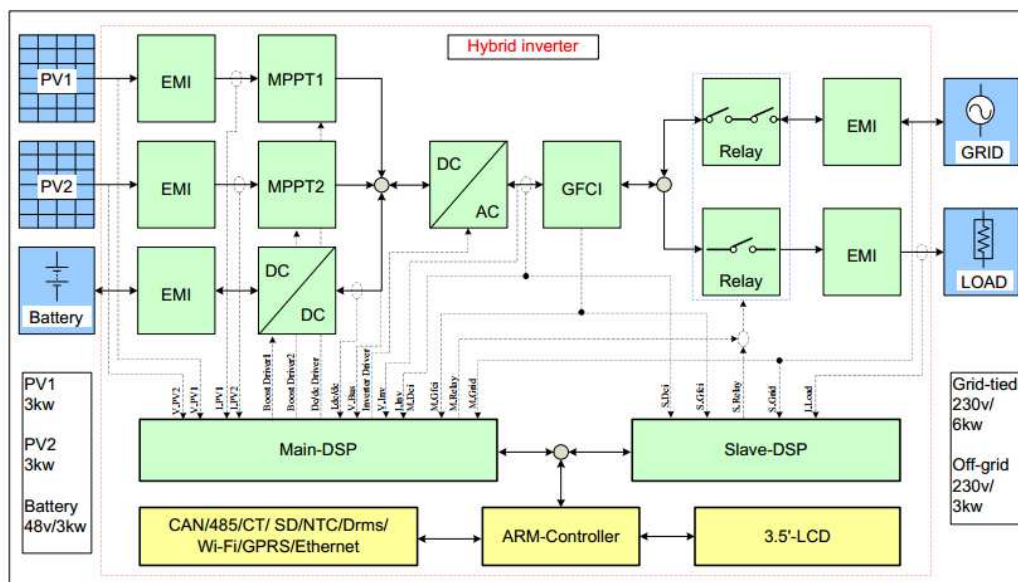

Figure 1 – Block diagram

The internal control is redundant built. It consists of Microcontroller Main DSP (U4) and slave DSP (U22).

The Main DSP (U4) control the relays by switching signals; measures the PV voltage, PV current, Bus voltage, grid voltage, frequency, AC current with injected DC and the array insulation resistance to ground. In addition it tests the current sensors and the RCMU circuit before each start up.

The slave DSP (U22) is measures the grid voltage, grid frequency and residual current, also can switch off the relays independently, and communicate with Main DSP (U4) each other.

The current is measured by a current sensor. The AC current signal and the injected DC current signal are sent to the Main DSP(U4). The Main DSP(U4) tests and calibrates before each start up all current sensors. The unit provides two relays in series in all output conductors. When single fault applied to one relay, alarm an error code in display panel, another redundant relay provides basic insulation maintained between the PV array and the mains. All the relays are tested before each start up.

The models HYD 3000-ES, HYD 3600-ES, HYD 4000-ES , HYD 5000-ES and HYD 6000-ES are completely identical and output power derated by software, except for the following table.

	HYD 6000-ES	HYD 5000-ES	HYD 4000-ES	HYD 3600-ES	HYD 3000-ES
(R332,R334,R336)	(0Ω, NC, 0Ω)			(NC, 0Ω, NC)	
Bus capacitance	8 pcs			6pcs	
INV inductor	0.75mH			1.035mH	
(R123,R132)	(1.5kΩ, 1.5kΩ)			(499Ω, 499Ω)	

The product was tested on:

Hardware version: V1.0

Software version: V1.00

Test condition:

Temperature: 20±5°C
Relative humidity: 60%
Air pressure: 950 mbar

The test sample was a pre-production sample without serial number.

The following deviations for France according DIN V VDE V 0126-1-1/A1 VFR2014 has been applied according Protections des installations de production raccordées Identification au réseau public de distribution, ERDF-NOI-RES_13E, Version 6, 11/07/2016.

Parameter	Max. clearance time	Trip setting
Over voltage	200ms	264,5V
Under voltage	200ms	184,0V
Over frequency	200ms	50,60Hz
Under frequency	200ms	47,50Hz
Reconnection time	>=30s	>=30s

The following deviations for French Islands to UTE C15-712-1 and DIN V VDE V 0126-1-1 (VDE V 0126-1-1):2006-02 have been applied according to protection de Découplage pour le Raccordement d'une production décentralisée en HTA et en BT dans les zones non interconnectées, référentiel technique – SEI REF 04, V6:

Parameter	Max. clearance time	Trip setting
Over voltage	200ms	255,3V
Under voltage	200ms	195,5V
Over frequency	200ms	52,0Hz
Under frequency	200ms	46,0Hz
Reconnection time	>=30s	>=30s

The following deviations for French Islands to UTE C15-712-1 and DIN V VDE V 0126-1-1 (VDE V 0126-1-1):2006-02 have been applied according to Contrat de raccordement, d'accès et d'exploitation (CRAE) pour une installation de production photovoltaïque raccordée au Réseau Public d'électricité:

Parameter	Max. clearance time	Trip setting
Over voltage	200ms	264,5V
Under voltage	200ms	195,5V
Over frequency	200ms	62,5Hz
Under frequency	200ms	55,0Hz
Reconnection time	>=30s	>=30s

UTE C15-712-1			
Clause	Requirement	Remark	Verdict
1	<p>Introduction</p> <p>The use of photovoltaic generators is growing for a variety of reasons, such as the generation of electricity in places that are difficult to access by public distribution networks or the development of renewable energy with production fed into the public network.</p> <p>The development of such generators requires the specification of implementation rules, which are the subject of this guide.</p> <p>The application of these rules does not remove the need to observe administrative regulations by which certain installations are bound.</p>		
2	<p>Applicability</p> <p>This guide deals with low-voltage photovoltaic installations connected to the low-voltage or high-voltage public distribution network.</p> <p>The a.c. modules (PV module and associated inverter) are not included in this guide. The installation of these is subject to the regulations set down in NF C 15-100.</p> <p>The only issue covered in this guide is operation under voltage on the public distribution network.</p>		
3	<p>Normative references</p> <p>NF EN 50380 (C 57-201)</p> <p>NF EN 50521 (CF57-339)</p> <p>NF EN 60269-1 (C 60-200-1)</p> <p>NF EN 60904-3 (C 57-323)</p> <p>NF EN 60947-1 (C 63-001)</p> <p>NF EN 60947-2 (C 63-120)</p> <p>NF EN 60947-3 (C 63-130)</p> <p>NF EN 61215 (C 57-105)</p> <p>NF EN 61439</p> <p>NF EN 61557-8 (C 42-198-8)</p> <p>NF EN 61643-11 (C 61-740)</p> <p>NF EN 61646 (C 57-109)</p> <p>NF EN 61730-1 (C 57-111-1)</p> <p>NF EN 61730-2 (C 57-111-2)</p> <p>NF EN 62262 (C 20-015)</p> <p>NF EN 62305-1 (C 17-100-1)</p> <p>NF EN 62305-2 (C 17-100-2)</p> <p>NF EN 62305-3 (C 17-100-3)</p> <p>NF C 14-100</p> <p>NF C 15-100</p> <p>NF C 17-102</p> <p>UTE C 15-105</p>		

UTE C15-712-1			
Clause	Requirement	Remark	Verdict
	UTE C 15-400		
	UTE C 15-520		
	UTE C 32-502		
	UTE C 17-100-2		
	UTE C 61-740-51		
	UTE C 61-740-52		
	UTE C 17-108		
	DIN VDE 0126-1-1		
	DIN EN61000-6-3		
4	In addition to the definitions set out in NF C 15-100, the following definitions apply to this guide:	Noticed.	P
5	Description of PV installations		P
6.	Earthing of the installation		P
6.1	Diagrams showing bonding of alternating current part with earth The earthing system has been produced in accordance with the requirements of NF C 15-100.	Must be taken under consideration for the installation.	N/A
6.2	Earthing of one polarity in the d.c. part In a PV installation, the protection devices against indirect contact are independent of the principle of the earthing systems. The direct current part is created in accordance with the rules for class II or equivalent isolation.	Must be taken under consideration for the installation.	N/A
6.3	Earthing of conductive masses and elements		P
6.3.1	Direct current part To minimise the effects of induced overvoltages, the metal structures of the modules and the metal support structures (including the metal cable runs) must be connected to equipotential bonding, which in turn is connected to the earth.	Must be taken under consideration for the installation.	N/A
6.3.2	Alternating current part All chassis on the a.c. side must be connected to the earth via a protective conductor that meets the requirements of paragraph 411.3.1.2 and section 5-54 of NF C 15-100. If a transformer is installed outside the inverter (low voltage/low voltage or high voltage/low voltage transformer), equipotential bonding is required between these items of equipment.	Must be taken under consideration for the installation.	N/A
6.3.3	Inverter The inverter body must be connected to the equipotential bonding via a conductor with a minimum cross-section of 6mm ² Cu or equivalent and to the protective conductor of the a.c. part.	A minimum cross-section of the protective earthing wire of 6mm ² is required in the manual.	P
7.	Protection against electric shock		P

UTE C15-712-1			
Clause	Requirement	Remark	Verdict
7.1	<p>General points</p> <p>The PV equipment of the direct current part must be treated as being under voltage, even if it is disconnected from the alternating current part.</p>		P
7.2	<p>Protective measure SELV or PELV by the DC part</p> <p>The requirements of SELV or PELV are described in Article 414 of the NF C 15-100 and are detailed below:</p> <ul style="list-style-type: none"> - The ac part of the plant is separated by a safety transformer according to the NF EN 61558-2-6 or safety converter according to the NF EN 61046, in accordance with 414.3 of the NF C 15-100. The safety transformer or safety converter can be integrated in the inverter or close to it if the link between the two devices is done with the Class II equipment or equivalent insulation. - PELV, a polarity of the d.c. part is grounded. - SELV is prohibited if the party d.c. includes a set of functional ground polarity <p>In cases where the protective measure by SELV or PELV is prohibited, the general protection measures apply (double or reinforced insulation).</p>	SELV is classified for communication ports.	P
7.3	<p>Protection against direct contact</p>		P
7.3.1	<p>General</p> <p>All connection points required for the realization of a PV string whose Uocmax voltage is above 60 V, should be insured by connectors including at its ends.</p> <p>These connectors must be conform to the EN 50521 standard.</p>	Must be taken under consideration for the installation.	P
7.3.2	<p>Case of the installation in LV</p> <p>Electrical equipment must be fitted with a form of protection either by insulation of the live parts or through a casing.</p> <p>The cabinets or boxes containing accessible live parts must be locked either with a key or with a tool, unless they are located in a place to which only authorised or qualified persons have access.</p> <p>If the boxes or cabinets are not located in a place to which only authorised or qualified persons have access, protection against direct access must be ensured when an access door is opened by installing equipment that, by the nature of its design or installation, has a minimum degree of protection of IP2X or IPXXB.</p>	The unit is rated IP 65	P

UTE C15-712-1			
Clause	Requirement	Remark	Verdict
7.3.3	<p>If the installation is SELV (extra-low voltage) and PELV (protective extra-low voltage)</p> <p>If the nominal voltage of the safety extra-low voltage circuit is less than or equal to 25 V rms a.c. or 60 V d.c. without ripple, protection against direct contact through insulation of the live parts or a casing is not necessary.</p> <p>If the nominal voltage of the protective extra-low voltage circuit is less than or equal to 12 V rms a.c. or 30 V d.c. without ripple, protection against direct contact through insulation of the live parts or a casing is not necessary.</p>	Unit is rated for voltages above 120V	N/A
7.4	Protection against indirect contact		P
7.4.1	<p>General</p> <p>The regulations for protection against indirect contact are set out in section 4-41 of NF C 15-100.</p> <p>The circuits covered by 411.3.3 of standard NF C 15-100 and, in particular, circuits in residential buildings must be protected with a differential device with a sensitivity of 30 mA or less.</p> <p>The aim of this section is to describe the different ways of protecting people against indirect contact in a photovoltaic installation according to the measures implemented on the d.c. side and the presence or otherwise of galvanic isolation via a transformer between the d.c. and a.c. parts.</p>	Must be taken under consideration for the installation.	N/A
7.4.2	Direct current part		N/A
7.4.2.1	<p>General</p> <p>For the direct current part (PV modules, junction boxes, chain cables, group cables, marshalling boxes or cabinets, etc.), protection against indirect contact must be ensured through at least one of the following measures:</p> <ul style="list-style-type: none"> • Protection through safety extra-low voltage or protective extra-low voltage; • Protection through double or reinforced insulation. <p>In the case of the installation of cabinets in a building or electrical service site where access is restricted to qualified personnel, this cabinet can be a class 1 cabinet.</p>	Must be taken under consideration for the installation.	N/A
7.4.2.2	Protection with double or reinforced insulation		N/A

UTE C15-712-1			
Clause	Requirement	Remark	Verdict
7.4.3	<p>Alternating current part</p> <p>Protection against indirect contact is ensured through double or reinforced insulation or by an automatic cut-out of the supply, according to one of the following measures:</p> <ul style="list-style-type: none"> In a TT system: cut-out on the first fault; In a TN system: cut-out on the first fault; In an IT system: cut-out on the second fault. 	The unit is only intended for TT or TN systems. The unit is rated class 1. In combination with the required differential device in clause 7.3.1 no hazard can occur in single fault.	P
8	Overcurrent protection		N/A
8.1	Direct current part		N/A
8.1.1	<p>General points</p> <p>See figure 7 of this standard</p>	Must be taken under consideration for the installation.	N/A
8.1.2	<p>Protection of PV modules</p> <p>In an installation with several PV module chains in parallel, the modules must be protected against the effect of reverse currents that may be generated in the chains in the event of a fault.</p>	Must be taken under consideration for the installation.	N/A
8.1.3	<p>Protection of PV chain cables</p> <p>The sizing of the PV chain cables takes into account the choice of protection device for the PV modules adopted in 8.1.2.</p>	Must be taken under consideration for the installation.	N/A
8.1.4	<p>Protection of PV group cables</p> <p>In an installation with several PV groups in parallel, the cables for the groups must be protected against the effect of reverse currents caused by a short circuit in a group.</p>	Must be taken under consideration for the installation.	N/A
8.1.5	<p>Protection of main PV cable</p> <p>The main cable of a PV generator must be dimensioned with a permissible current I_z greater than or equal to $1.25 I_{scSTC_gen}$.</p>	Must be taken under consideration for the installation.	N/A
8.1.6	<p>Characteristics of overcurrent protection devices</p> <p>The overcurrent protection devices must be either fuses compliant with standard NF EN 60269-1 or circuit-breakers compliant with standard NF EN 60947-2. These devices must be implemented for both polarities, regardless of the configuration of the installation.</p>	Must be taken under consideration for the installation.	N/A
8.2	Alternating current part		N/A

UTE C15-712-1			
Clause	Requirement	Remark	Verdict
8.2.1	<p>General points</p> <p>In the case of an installation connected to the network via a branch line with limited power, the minimum cross-section of the conductors connected to the terminals downstream of the general isolating and protection device is 10 mm² Cu.</p>	Must be taken under consideration for the installation.	N/A
8.2.2	<p>Overload protection</p> <p>Alternating current circuits are protected against surges in accordance with the requirements of article 433 of standard NF C 15-100.</p>	Must be taken under consideration for the installation.	N/A
8.2.3	<p>Short-circuit protection</p> <p>In the case of a short circuit in an inverter or its line, the inverter is regarded as the load and the public network as the source.</p>	Must be taken under consideration for the installation.	N/A
9.	<p>Interface protection</p> <p>This protection device is designed to disconnect generators in the event of:</p> <ul style="list-style-type: none"> • a fault on the public distribution network; • a failure in the supply from the public distribution network; • fluctuations in the voltage or frequency greater than those specified by the distributor. 	The unit provides a integral disconnection facility according to VDE 0126-1-1 an it is rated below 250kW	P
10	<p>Prevention of degradation of photovoltaic installations</p> <p>In order to prevent the degradation of PV installations due to specific external influences and the presence of direct current, and despite the implementation of measures such as the installation of double insulation and monoconductor cables, additional measures must be implemented for the direct current part.</p>	The inverter is applicable to be used for no galvanic insulation and PV array not earthed	P
11	<p>Voltage drop</p>		N/A
11.1	<p>General points</p> <p>The objective of technical and commercial optimisations is to minimise voltage drops.</p>	Must be taken under consideration for the installation.	N/A
11.2	<p>Direct current installation</p> <p>The authorised maximum drop in voltage in the direct current part of the installation is between 3% and $I_{mp} V_{oc}$ (STC: standard test conditions).</p>	Must be taken under consideration for the installation.	N/A

UTE C15-712-1			
Clause	Requirement	Remark	Verdict
11.3	<p>Alternating current installation</p> <p>For PV installations connected directly to the LV public distribution network, the maximum authorised drop in voltage between the a.c. terminals of the inverter and the point of delivery (NF C 14-100) is 3% at the nominal power of the inverter(s). It is recommended to limit this drop in voltage to 1% in order to be able to limit energy losses on the one hand and momentary disconnection of the inverter on the other, maintaining a margin between the average operating voltage of the inverter and the setting of its protection at maximum voltage.</p>	Must be taken under consideration for the installation.	N/A
12.	Isolation, control and disconnection		N/A
12.1	<p>Isolation / Disconnection</p> <p>To facilitate maintenance of the PV inverters, disconnection mechanisms must be installed close to the inverter, on both direct current and alternating current sides.</p> <p>NOTE For high power inverters whose maintainability can be ensured by replacement of internal components, the isolating device can be integrated in the same envelope.</p> <p>All disconnectors must be omnipolar.</p> <p>The disconnector installed on the direct current side does not have to be with simultaneous opening of each polarity.</p>	Must be taken under consideration for the installation.	N/A
12.2	<p>Control</p> <p>To allow maintenance work on junction boxes fitted with protection devices, a circuit-breaker must be installed inside or immediately downstream of these protection devices.</p>	Must be taken under consideration for the installation.	N/A
12.3	Emergency circuit-breakers		N/A
12.3.1	<p>General points</p> <p>In accordance with the regulations set down in articles 463 and 536.3 of standard NF C 15-100, emergency circuit-breakers must be fitted on both a.c. and d.c. sides in order to cut off the electricity supply in the event of an unexpected hazard.</p> <p>All emergency circuit-breakers must effect an omnipolar and simultaneous disconnection. These devices are either switches or breakers or contactors. The semiconductor devices do not comply with this requirement. The controls of emergency circuit-breakers on both d.c. and a.c. sides must be easily recognisable and quickly accessible.</p> <p>Emergency circuit-breakers must not be built into the inverter.</p> <p>NOTE For high-power inverters, the switchgear device can be integrated in the same envelope.</p>	Must be taken under consideration for the installation.	N/A

UTE C15-712-1			
Clause	Requirement	Remark	Verdict
12.3.2	<p>Emergency cutoff of the DC part</p> <p>A cut-off device must be provided upstream from the inverter and its control shall be located close to this one.</p> <p>The emergency disconnection can be ensured by manual control of the circuit-breaker or via a remote control action.</p> <p>It must be possible to cut each supply to the inverter. In the case of inverters with multiple inputs, it is permissible to ensure an emergency disconnection by means of separately controlled devices.</p>	Must be taken under consideration for the installation.	N/A
12.3.3	Alternating current part		N/A
12.3.4	<p>Measures specific to residential buildings</p> <p>In conformity with the regulations set down in article 771.463 of standard NF C 15-100, the emergency circuit-breakers must be tripped by a direct manual action.</p> <p>If the route between the inverter and the network passes through the residential part, the emergency circuit-breaker of the PV installation must be installed in the residential service duct of the building, if there is one, in accordance with articles 771.463 and 771.558 of standard NF C 15-100.</p>	Must be taken under consideration for the installation.	N/A
12.4	Cut-out for intervention by emergency services	Must be taken under consideration for the installation.	N/A

UTE C15-712-1			
Clause	Requirement	Remark	Verdict
12.4.1	<p>General</p> <p>If a cut-out is required to allow the intervention of the emergency services, this must be triggered by one of the following events:</p> <ul style="list-style-type: none"> • Cut-out of all sources of electrical energy <ul style="list-style-type: none"> ○ PV generator ○ Public distribution network • Switching devices must meet the following principles <ul style="list-style-type: none"> ○ these devices are either switches or breakers or contactors; the semiconductor devices do not comply with this requirement; ○ each device must be omnipolar and simultaneous interruption; • the failure of the PV generator circuit is done as close to the photovoltaic modules and in any case upstream of accessible rooms and passages to the occupants; • orders for these switching devices for intervention of emergency services are grouped. In the case of facilities on an existing building, it is assumed to have non-grouped commands. <p>The switching devices can be:</p> <ul style="list-style-type: none"> • Mechanical direct action; • Remote-controlled (electric or pneumatic) <p>The remote control may be provided by one of three principles:</p> <ul style="list-style-type: none"> • Trigger voltage loss; • trigger current or powered engine emissions, through CR1 type cable, by AES (Safety Electric Power) implemented under subsection 562.8 of the NF C 15-100; • pneumatic actuator with a compressed gas energy source and copper pipes or steel tube (according to standard NF EN 12101). <p>Signaling the action disconnection should be done by voltage measurements indications or voltage free loop devices by type O / F. In the case of using the DC voltage measurement, it should then be taken between the separating apparatus and the area to be secured. The cables used for signaling are CR1 type.</p> <p>This signal is provided by the extinction of a white LED that indicates the actual disconnection.</p>	<p>Must be taken under consideration for the installation.</p>	N/A

UTE C15-712-1			
Clause	Requirement	Remark	Verdict
12.4.1	<p>Additional provisions If it is required that the voltage of the PV generator is below 60 Vdc, the circuit upstream of the required disconnection is general in provisions of 12.4.1, this is achieved by:</p> <ul style="list-style-type: none"> • an electromechanical load breaking or unloaded in series in each string by PV Uocmax section whose voltage is lower or equal to 60 V, or • electromechanical short-circuit or electronic systems by Uocmax section whose voltage is lower or equal to 60 V, or • electromechanical or electronic shorting by Modular Systems <p>The operational safety of these principles requires:</p> <ul style="list-style-type: none"> • a positive safety control; • in the case of an electromechanical load cut off, his order should be performed after the charge downstream switching device. The implementation of this equipment must be comply with the rules of double insulation (or reinforced insulation) imposed in this part of the system and for a voltage corresponding to the chain tension Uocmax. 	Must be taken under consideration for the installation.	N/A
13	Protection from surges emanating from the atmosphere or caused by operations		N/A
13.1	<p>General points The information contained in this chapter refers to overvoltage protection for photovoltaic installations connected to the network and complements standard NF C 15-100 and guide UTE C 61-740-52.</p>	Must be taken under consideration for the installation.	N/A
13.1.1	Types of protection		N/A
13.1.1.1	<p>Protection through equipotential bonding As described in section 6.3, an equipotential bonding conductor must connect all the metal structures of the modules and the metal structures of the supports of the PV installation (including the metal cable runs) whether or not lightning conductors are present. This conductor must be connected to the earth.</p>	Must be taken under consideration for the installation.	N/A
13.1.1.2	<p>Protection by lightning arresters The installation conditions are described in 13.2.</p>	Must be taken under consideration for the installation.	N/A
13.2	Installation conditions for lightning arresters		N/A

UTE C15-712-1			
Clause	Requirement	Remark	Verdict
13.2.1	Installation conditions for lightning arresterson a.c. side Based on guide UTE C 61-740-52, protection by a lightning arrester is obligatory if there is a lightning conductor or if the lightning density (Ng) is greater than 2.5.	Must be taken under consideration for the installation.	N/A
13.2.2	Installation conditions for lightning arresters on d.c. side		N/A
13.2.2.1	Installation without lightning conductor The length L is the accumulated distance between the inverter(s) and the furthest points of the photovoltaic modules comprising the chain, as a sum of the lengths of the routes in accordance with the principles shown in Figure 7.	Must be taken under consideration for the installation.	N/A
13.2.2.2	Installation with lightning conductor The installation of type 2 lightning conductor(s) is obligatory on the d.c. side.	Must be taken under consideration for the installation.	N/A
13.3	Overvoltage protection for installations without lightning conductor	Must be taken under consideration for the installation.	N/A
13.3.1	Choice and installation of lightning arresters on a.c. side If a lightning arrester is prescribed for the a.c. part of a PV installation connected to the public low-voltage distribution network, it is always installed in the panel nearest to the installation origin of the installation. If this lightning arrester is located more than 10 metres away from the inverter, a second lightning arrester must be installed near the latter.	Must be taken under consideration for the installation.	N/A
13.3.2	Choice and installation of lightning arresters on d.c. side If a lightning arrester is prescribed for the d.c. part of a PV installation, it is always installed in the panel nearest to the inverter. If one of the chains is located more than 10 metres away from the inverter, the installation of a second lightning arrester near the chains is recommended.	Must be taken under consideration for the installation.	N/A
13.3.2.1	Choice of I_n The lightning arresters are type 2 with a minimum value for the nominal discharge current I_n of 5 kA. A higher nominal discharge current than the required value will prolong the service life of the lightning arrester.	Must be taken under consideration for the installation.	N/A
13.3.2.2	Choice of I_{max} This parameter is used to coordinate the energy of the lightning arresters: please refer to information from the manufacturer.	Must be taken under consideration for the installation.	N/A

UTE C15-712-1			
Clause	Requirement	Remark	Verdict
13.3.2.3	<p>Choice of I_{imp} The impulse current I_{imp} for Type 1 arresters is chosen according to the UTE C 61-740-52 guide or by default with a minimum value of 12.5 kA.</p>	Must be taken under consideration for the installation.	N/A
13.3.2.4	<p>Choice of U_p The value of U_p must be less than 80% of the surge withstand voltage of the equipment to be protected.</p>	Must be taken under consideration for the installation.	N/A
13.3.2.5	<p>Choice of U_{CPV} The value of the maximum permissible voltage from the lightning arrester UCPV must be selected according to the maximum open-circuit voltage of the PV generator corresponding to the voltage U_{ocSTC} specified by the manufacturers of the PV modules. The voltage UCPV must be greater than or equal to the maximum voltage U_{ocMAX} of the photovoltaic generator. Whatever the protection methods of the lightning arrester, it must also withstand the maximum voltage U_{ocMAX} between these live terminals (+ and - terminals) and the earth.</p>	Must be taken under consideration for the installation.	N/A
13.3.2.6	<p>Choice of I_{SCPV} and protection device associated with the lightning arrester I_{SCPV} keeping abreast short of an arrester system The lightning arrester must be fitted with an external disconnection device, if specified by the manufacturer; this assembly must be sized to function regardless of the current produced by the PV modules. Note: The lightning arresters can come to the end of their service life for the following reasons:</p> <ul style="list-style-type: none"> • Due to overheating caused by an excessive accumulation of lightning stresses that do not exceed the normal characteristics of the lightning arrester but lead to a gradual destruction of its internal components; • Short-circuiting caused by the normal characteristics of the lightning arrester being exceeded, leading to a drastic reduction in its impedance. <p>The maximum value I_{scPV} of the current permitted by the lightning arrester and any disconnecter it may have must be selected according to the current I_{scpv} that may be delivered by the photovoltaic generator. The I_{SCPV} current must be greater than or equal to I_{scmax} of the PV generator. Lightning arresters for which fulfilment of this parameter is not stated must not be used.</p>	Must be taken under consideration for the installation.	N/A

UTE C15-712-1			
Clause	Requirement	Remark	Verdict
13.4	<p>Additional regulations for surge protection for installations with a lightning conductor</p> <p>The regulations are set out in guide UTE C 61-740-52.</p>	Must be taken under consideration for the installation.	N/A
14.	Choice and installation of equipment		P
14.1	<p>General points</p> <p>The rated operating voltage of all the equipment of the d.c. part must be equal to or greater than the voltage UOCMAX.</p> <p>In the case of buildings with multiple occupation (for tertiary or residential use) with photovoltaic production in communal parts, the lines coming from the PV modules must be routed round the outside of private areas to the junction boxes for the chain/group located in the communal areas or in the buildings or the electrical service site dedicated to this purpose.</p> <p>The equipment installed outside must have a minimum degree of protection of IP44. The degree of protection against mechanical impacts must be at least IK07 in compliance with standard NF EN 62262 (C 20-015).</p> <p>It must be possible to carry out work on the removable equipment, devices and connections in the utmost safety.</p> <p>If a transformer is installed, the inverters and any general low-voltage panel must be installed close to the transformer in the same room or in adjoining rooms.</p> <p>The location of equipment (junction box(es), inverter(s), cabinets with protection devices and meter cabinets etc.) must comply with article 513.1 of standard NF C 15-100. Special regulations for residential buildings are given in article 771. The equipment, including the ducts etc., must be arranged so that they can be operated, inspected and serviced easily and their connections can be accessed.</p>	The inverter is rated IP65 and IK07. For IK see test results below.	P
14.2	Ducts etc.		N/A
14.2.1	<p>Choice for the d.c. part</p> <p>The ducts are sized in accordance with the regulations in standard NF C 15-100 on the basis of cables with reticulated polyethylene insulation.</p>	Must be taken under consideration for the installation.	N/A
14.2.2	<p>Installation</p> <p>The connections and the cables must be installed in a manner that will prevent any deterioration due to external influences. See the requirements set out in guide UTE C 15-520.</p>	Must be taken under consideration for the installation.	N/A

UTE C15-712-1			
Clause	Requirement	Remark	Verdict
14.3	<p>PV modules</p> <p>The PV modules must comply with the standards in series NF EN 61730.</p>	Must be taken under consideration for the installation.	N/A
14.4	<p>Inverters</p> <p>The inverters must be comply with IEC 62109-1 and EN 62109-2.</p> <p>The level of the current for the inverter must be based on ImpSTC.</p> <p>Direct current generated by invertes injected on the public distribution network must be less than 0.5% of its rated current.</p>	<p>Comply with IEC 62109-1 and IEC 62109-2.</p> <p>Details see report No. LD180903N042-R1, issued by Bureau Veritas Shenzhen Co., Ltd. Dongguan Branch.</p> <p>For DC injection, see table 6.4 below.</p>	P
14.5	<p>Equipment</p> <p>All equipment installed in the d.c. part must be adapted for operation in direct current and be selected and installed in accordance with the manufacturer's instructions.</p> <p>Equipment installed in the d.c. part must be of the industrial type, in other words compliant with the NF EN 60947 series of standards.</p> <ul style="list-style-type: none"> • The characteristics of switches, switch-disconnectors and fuse-combination units must conform to the operating category DC21B. • The characteristics of disconnectors must conform to the operating category DC20. • The characteristics of contactors must conform to the operating category DC1. 	<p>The DC switch of the inverter is rated for operation category DC21B.</p> <p>Connectors in the DC lines are rated for operation category DC1.</p>	P

UTE C15-712-1			
Clause	Requirement	Remark	Verdict
14.6	<p>Equipment assemblies</p> <p>The direct current and alternating parts of the installation can be accommodated in the same panel if there is a physical separation of these two parts.</p> <p>For the d.c. part, it is imperative to protect all the connections or disconnection devices against accidental or unauthorised opening when live in accordance with 536.2.3 of standard NF C 15-100. To this end, a notice "Do not operate when live" must be placed inside the boxes or cabinets near these disconnection devices.</p> <p>Furthermore, in premises accessible to persons other than those with the requisite authorisation or qualification (BA4 or BA5):</p> <ul style="list-style-type: none"> The design or installation must be such that it is only possible to disassemble the connection devices with the aid of a tool; Equipment that does not have an under load circuit-breaking feature must require the either the use of a key or tool or the direct operation of a device with an under load circuit-breaking feature. 	The PV input connectors can not be removed with out a aid of a tool. In addition there is a marking adjent the connectors with states "Do not operate when live"	P
14.7	<p>Connectors</p> <p>In the d.c. part, the connectors used must comply with the standard NF EN 50521. To guarantee the quality of the connection and limit the risks of an electric arc that could spark a fire, each pair of male and female connectors to be assembled must be of the same type and the same brand.</p>	The unit provide only one type and brand of connectors fro DC with male and female plugs, which are not interchangeable. The plugs are according to EN 50521	P
14.8	<p>Lightning arresters</p>	Must be taken under consideration for the installation.	N/A
14.8.1	<p>Choice of lightning arresters</p> <p>The lightning arresters installed in the a.c. part of the PV installation must comply with standard NF EN 61643-11.</p> <p>The lightning arresters installed in the d.c. part of the PV installation must meet the requirements of guide UTE C 61-740-51.</p>	The surge arrestors incoperated in the inverter are not according to EN 61643-11 or UTE C 61-740-51. Therefore an external lightning protection device must be installed.	N/A
14.8.2	<p>Installation of lightning arresters</p> <p>Alternating current and direct current lightning arresters are installed in accordance with the regulations set out in guide UTE C 61-740-52.</p>	Must be taken under consideration for the installation.	N/A
15	<p>Markings</p>		P

UTE C15-712-1			
Clause	Requirement	Remark	Verdict
15.1	<p>Identification of components</p> <p>The main components comprising the photovoltaic installations must be identified and marked with clearly visible labels fixed permanently in accordance with the installation plans and diagrams:</p>	The inverter provides permanent marking.	P
15.2	<p>Labelling</p> <p>For safety reasons and to alert the different people carrying out work in and around the building (staff tasked with maintenance work, inspectors, public distribution network operators, emergency services, etc.), it is imperative that the presence of a photovoltaic installation on a building is indicated.</p>		P
15.2.1	Labelling on the a.c. part	Must be taken under consideration for the installation.	N/A
15.2.2	<p>Labelling on the d.c. part</p> <p>All the junction boxes (PV generator and PV groups) and d.c. ducts must carry a visible and permanent marking indicating that live parts within these boxes may remain under voltage even after the inverter has been disconnected on the direct current side.</p>	Must be taken under consideration for the installation.	N/A
15.3.2	<p>Labelling on the inverter</p> <p>All inverters must bear a marking indicating that before any work is carried out, the two sources of voltage must be isolated.</p>	The unit is provided with the applicable marking	P
16.	<p>Technical file</p> <p>The technical file must include the following items drawn up in French:</p> <ul style="list-style-type: none"> • A circuit diagram of the photovoltaic system; • The list of installed equipment mentioning the characteristics and references to the replacement parts (fuses, lightning arrester cartridges etc.); • An installation diagram for the various photovoltaic components and modules as well as the corresponding connections (ducts); • A description of the procedure for working on the photovoltaic system and safety instructions. 	The required information are stated in the manual.	P
17.	Maintenance of photovoltaic installations		N/A

UTE C15-712-1			
Clause	Requirement	Remark	Verdict
17.1	<p>General points</p> <p>The minimal technical maintenance work must be provided for during the life cycle of a photovoltaic installation to maintain or restore the installation to a state in which it can fulfil the function for which it was designed.</p>	Must be taken under consideration for the installation.	N/A
17.2	<p>Levels and frequency of maintenance</p> <p>A distinction is made between the following three levels of maintenance comprising:</p> <ul style="list-style-type: none"> • Conditional maintenance based on monitoring of the key parameters of the installation; • Precautionary maintenance carried out according to the prognoses extrapolated from the analysis and evaluation of the key parameters concerning the degradation of the asset (e.g. corrosion); • Systematic maintenance carried out at predetermined intervals and without a prior check of the state of the product or its constituent components. 	Must be taken under consideration for the installation.	N/A
17.3	<p>Technical areas covered during maintenance</p> <p>A distinction is made between operations relating to the safety of persons and property, and actions relating to functional reliability.</p>	Must be taken under consideration for the installation.	N/A
<p>Annex A</p> <p>Agreements between the administrator of the public distribution network and the user/produce</p>			
A1	<p>Provisions for limiting effects adversely affecting supply quality</p> <p>The study of the connection by the administrator of the public distribution network requires the communication of the characteristic data for the project, the generators and the provisions for connection to the network. The administrator of the public distribution network may disclose data sheets summarising the minimum list of data required to study the request.</p>	Must be taken under consideration for the installation.	N/A
A2	<p>Choice of tripping device and approval</p> <p>The installation or modification of a tripping device must be subject to an agreement with the administrator of the public distribution network.</p> <p>This process must take account of the situation and the features at the point of delivery and must therefore, where necessary, be coordinated with the connection study for the site.</p>	Must be taken under consideration for the installation.	N/A

UTE C15-712-1			
Clause	Requirement	Remark	Verdict
A3	<p>Start-up by the administrator of the public distribution network</p> <p>For installations with a power of less than 250 kVA, this step is subject to prior submission of proof of conformity stamped by CONSUEL (Comité National pour la Sécurité des Usagers de l'Electricité, the National Committee for the Safety of Users of Electricity).</p>	Must be taken under consideration for the installation.	N/A
<p>Annex B</p> <p>Cables for photovoltaic installations - values for permissible currents</p> <p>(informative)</p>			
	Specific cables for photovoltaic installations have been refined in order to meet the needs of these installations. The tables below, taken from document UTE C 32-502, give the values for the permissible currents for cables compliant with this guide.	Must be taken under consideration for the installation.	N/A
<p>Annex C</p> <p>Keraunic levels in France and in the overseas departments</p> <p>(informative)</p>			
	<i>Note – To obtain the corresponding lightning density (Ng), simply divide Nk by 10.</i>		--

Test Results

14.1 IEC 60068-2-75 (Hammer test)										P
Use method	Swing hammer			Spring hammer			Vertical hammer			
	N/A			P			N/A			
Severity										
Repeats	3 Hits unless otherwise specified									
Energy (J)	0,14	0,2	0,35	0,5	0,7	1	2	5	10	20
Mass (kg)	0,25						--	1,7	5	5
Radius (mm)	10						--	25	50	50
IK code	IK01	IK02	IK03	IK04	IK05	IK06	IK07	IK08	IK09	IK10
	N/A	N/A	N/A	N/A	N/A	N/A	P	N/A	N/A	N/A

Note:

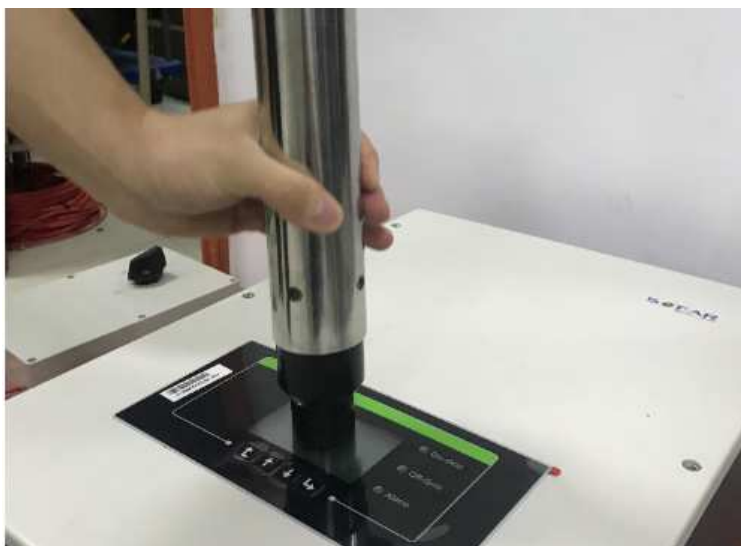



Report No.: PVFR180903N042

Annex 1

DIN V VDE V 0126-1-1/A1 VFR2014 Test Report

DIN V VDE V 0126-1-1/A1 VFR2014

Clause/§	Requirement	Remark	Verdict
----------	-------------	--------	---------

1	Scope (Automatic disconnecting facility for photovoltaic installations)		
----------	--	--	--

2	Normative references		
		DIN EN 50160:2003-03	
		DIN EN 50178 (VDE 0160):1998-04	
		DIN EN 60664-1 (VDE 0110-1)	
		E DIN VDE 0664-100:2005-05	
		DIN EN 61000-6-2	
		DIN EN61000-6-3	
		DIN EN 61008-1 (VDE 0664-10):2000-09	
		DIN VDE 0105-100:2000-06	
4	Requirements:		
	1. Monitoring of voltage and frequency derivation		
	2. Monitoring of DC-Injection		
	3. Monitoring of accidental anti Islanding		
	4. Monitoring of intended anti Islanding		
	5. Residual Current Monitoring Unit –RCMU (only if no galvanic separation)		
4.1	Functional safety: Automatic disconnecting facility	Considered, see annex. The single fault safe system was reviewed. The theoretical investigation was verified by error simulation.	P
4.1.1	Single fault safety of the automatic disconnecting facility	Considered, see block diagram, functional explanation and table 6.1 below.	P
4.1.2	Disconnection device: At least two independent disconnection devices. At least one relay and one switch with overvoltage category 2. If without galvanic separation then two relays are necessary	Disconnection takes place redundant through two relays and the IGBT-fullbridge in series. The relays and the IGBT-full bridge are able to switch the full current.	P
4.2	Monitoring of the voltage: Voltages $\leq 80\%$ and $\geq 115\%$ of V_{nom} cause a disconnection within 0,2s (reconnection after min. 5s if voltage fluctuation $\leq 3s$; min. 30s if voltage fluctuation $> 3s$). Test voltage steps should not be below 77% and above 118% of V_{nom} . Continuous over voltage above 110% up to 115% (adjustable, default setting 110%) causes disconnection after max. 10min. Re-connection after min. 30s.	Tested with a variable AC-Power supply at the output. Inverter disconnects within the limits, see table 6.2 below.	P

DIN V VDE V 0126-1-1/A1 VFR2014

Clause/§	Requirement	Remark	Verdict
4.3	Monitoring of frequency: Frequencies $\leq 47,5\text{Hz}$ and $\geq 51,5\text{Hz}$ cause a disconnection within 0,2s (frequenz derivation 1Hz/s)	Tested with an AC-Source at the output. See table 6.3 below.	P
4.4	Monitoring of DC-Injection: DC error or DC-Currents $\geq 1\text{A}$ cause disconnection within 0,2s (positive and negative polarity)	See table 6.4 below.	P
4.5	Detection of anti islanding: anti islanding causes disconnection within 5s (for multiple installations 0,2s if triggered external). For the detection of anti-islanding is only one of the following methods necessary: -6.5.1 Measurement of impedance or -6.5.2 Resonant circuit test or -6.5.3 3-phase grid-voltage monitoring	See table 6.5.2 below.	P
4.6	Marking: In case of an automatic disconnecting facility there is a note at the type plate necessary	Marking provided on the type label.	P
4.7	Special requirements:		
4.7.1	Photovoltaics: If without galvanic separation then a RCMU is necessary. Insulation resistance $> 1\text{k}\Omega/\text{V}$, at least 500k Ω . Slowly increasing DC-Leaking currents up to 300mA cause disconnection within 0,3s / Surge dc-leakage currents should lead to a disconnection of: -30mA within 0,3s -60mA within 0,15s -150mA within 0,04s Before every connection to the grid, the d.c. array ground insulation has to be checked. (see 6.6.2.2.4).	For Residual Current Monitoring see table 6.6 below.	P
5	General requirements:		
	Electromagnetic compatibility (EMC)		
	Emitted interference <i>DIN EN 61000-6-3 (VDE 0839-6-3)</i>	Covered by EMC report Report No.: CE180903N042, issued by Bureau Veritas Shenzhen Co., Ltd. Dongguan Branch	P
	Interference resistance <i>DIN EN 61000-6-2 (VDE 0839-6-2)</i>	Covered by EMC report Report No.: CE180903N042, issued by Bureau Veritas Shenzhen Co., Ltd. Dongguan Branch	P
6	Type test :	See following test report	
7.	Routine test:	Routine testing described above	P
8	Specification of installation:		P

DIN V VDE V 0126-1-1/A1 VFR2014			
Clause/§	Requirement	Remark	Verdict
Annex			
A.1	Additional Methods of monitoring anti islanding:	Additional Methods can be added	N/A
A.4	Disconnection for a short period	If frequency fluctuation of $\leq 3s$ occur, the reconnection after min. 5s is permitted.	P

DIN V VDE V 0126-1-1/A1 VFR2014		
Clause	Test	Result
6.1 (4.1)	Functional safety	P
6.2 (4.2)	Monitoring of voltage	P
6.3 (4.3)	Monitoring of frequency	P
6.4 (4.4)	Monitoring of DC-Injection	P
6.5 (4.5)	Detection of anti-islanding (only one method is necessary!)	
	6.5.1 Measurement of impedance	N/A
	6.5.2 Resonant circuit test	P
	6.5.3 3-phase grid-voltage monitoring	N/A
6.6 (4.7)	Residual Current Monitoring	P

Test Results

6.1 Functional safety - fault condition tests								P
	Ambient temperature [°C] :	24,6						—
	Model/type of power supply :	DC : 62150H-1000S AC : 61512						—
	Manufacturer of power supply :	Chroma						—
	Rated markings of power supply :	DC: 0-1000V, 15kW AC: 0-300V, 18kW						—
Component No.	Fault	Test condition		Test time	Fuse No.	Fault condition		Result
		AC	DC			AC	DC	
Relay RY1 defect	Short circuit before energized	230V 0.02A	520V 0.02A	3Min.	--	230V 0.02A	520V 0.02A	Indicate Relay fault, error code "ID55" (RecoverRelayFail). Do not connect to AC mainsn. No damage, no hazards.
Relay RY2 defect	Short circuit before energized	230V 0.02A	520V 0.02A	3Min.	--	230V 0.02A	520V 0.02A	Indicate Relay fault, error code "ID55" (RecoverRelayFail). Do not connect to AC mainsn. No damage, no hazards.
Relay RY3 defect	Short circuit before energized	230V 0.02A	520V 0.02A	3Min.	--	230V 0.02A	520V 0.02A	Indicate Relay fault, error code "ID55" (RecoverRelayFail). Do not connect to AC mainsn. No damage, no hazards.
Relay RY4 defect	Short circuit before energized	230V 0.02A	520V 0.02A	3Min.	--	230V 0.02A	520V 0.02A	Indicate Relay fault, error code "ID55" (RecoverRelayFail). Do not connect to AC mainsn. No damage, no hazards.
Relay RY5 defect	Short circuit before energized	230V 0.02A	520V 0.02A	3Min.	--	230V 0.02A	520V 0.02A	Indicate Relay fault, error code "ID55" (RecoverRelayFail). Do not connect to AC mainsn. No damage, no hazards.
Relay RY6 defect	Short circuit before energized	230V 0.02A	520V 0.02A	3Min.	--	230V 0.02A	520V 0.02A	Indicate Relay fault, error code "ID55" (RecoverRelayFail). Do not connect to AC mainsn. No damage, no hazards.
Monitoring voltage defect R508	short	230V 26.2A	520V 12.1A	3Min.	--	230V 0.02A	520V 0.02A	Output a.c. relays operated, disconnected with grid. Q59 damage. No hazards.
Monitoring voltage defect Q59 pin 1-2	short	230V 26.2A	520V 12.1A	3Min.	--	230V 0.02A	520V 0.02A	Output a.c. relays operated, disconnected with grid , error code "ID55" (RecoverRelayFail). No damage, no hazards.

Monitoring voltage defect U46 pin 1-2	short	230V 26.2A	520V 12.1A	3Min.	--	230V 0.02A	520V 0.02A	Output a.c. relays operated, disconnected with grid , error code "ID55" (RecoverRelayFail). U46 damage, no hazards.
Monitoring voltage defect R511	short	230V 26.2A	520V 12.1A	3Min.	--	230V 0.02A	520V 0.02A	Output a.c. relays operated, disconnected with grid , error code "ID55" (RecoverRelayFail). U46 damage, no hazards.
Monitoring voltage defect R509	open	230V 26.2A	520V 12.1A	3Min.	--	230V 0.02A	520V 0.02A	The unit was in check state. No damage. No hazards.
Monitoring voltage defect U46 pin 3-4	short	230V 26.2A	520V 12.1A	3Min.	--	230V 0.02A	520V 0.02A	Output a.c. relays operated, disconnected with grid , error code "ID55" (RecoverRelayFail). U46 damage, no hazards.
Voltage measurement disabled R204	Open	230V 26.2A	520V 12.1A	3Min.	--	230V 0.02A	520V 0.02A	Output a.c. relays operated, disconnected with grid , error code "ID01" (The grid voltage is too high). No damage. No hazards.
Loss of control XL1	Short	230V 26.2A	520V 12.1A	3Min.	--	230V 0.02A	520V 0.02A	Output a.c. relays operated, disconnected with grid , error code "ID53, ID54" (SPI communication is fault, SCI communication is fault). No damage. No hazards.
Loss of control C738(3.3V DD)	Short	230V 26.2A	520V 12.1A	3Min.	--	230V 0.02A	520V 0.02A	Output a.c. relays operated, disconnected with grid , error code "ID53, ID54" (SPI communication is fault, SCI communication is fault). No damage. No hazards.
Communication microcontroller defect U4 pin1 to pin2	Short	230V 26.2A	520V 12.1A	3Min.	--	230V 0.02A	520V 0.02A	Output a.c. relays operated, disconnected with grid , error code "ID53, ID54, ID75" (SPI communication is fault, SCI communication is fault, Unrecoverable EEPROM write). No damage. No hazards.
ISO defect R531	Short circuit before energized	230V 26.2A	520V 12.1A	3Min.	--	230V 0.02A	520V 0.02A	Indicate ISO fault, error code "ID56" (The insulation resistance is too low). Do not connect to AC mainsn. No damage, no hazards.
ISO defect R598	Open circuit before energized	230V 0.02A	520V 0.02A	3Min.	--	230V 0.02A	520V 0.02A	Indicate ISO fault, error code "ID56" (The insulation resistance is too low). Do not connect to AC mainsn. No damage, no hazards.
ISO defect R602	Short circuit before energized	230V 0.02A	520V 0.02A	3Min.	--	230V 0.02A	520V 0.02A	Indicate ISO fault, error code "ID56" (The insulation resistance is too low). Do not connect to AC mainsn. No damage, no hazards.

ISO defect R605	Open circuit before energized	230V 0.02A	520V 0.02A	3Min.	--	230V 0.02A	520V 0.02A	Indicate ISO fault, error code "ID56" (The insulation resistance is too low). Do not connect to AC mainsn. No damage, no hazards.
ISO defect R355	Short circuit before energized	230V 0.02A	520V 0.02A	3Min.	--	230V 0.02A	520V 0.02A	Indicate ISO fault, error code "ID56" (The insulation resistance is too low). Do not connect to AC mainsn. No damage, no hazards.
ISO defect R303	Open circuit before energized	230V 0.02A	520V 0.02A	3Min.	--	230V 0.02A	520V 0.02A	Indicate ISO fault, error code "ID56" (The insulation resistance is too low). Do not connect to AC mainsn. No damage, no hazards.
ISO defect R307	Short circuit before energized	230V 0.02A	520V 0.02A	3Min.	--	230V 0.02A	520V 0.02A	Indicate ISO fault, error code "ID56" (The insulation resistance is too low). Do not connect to AC mainsn. No damage, no hazards.
ISO defect U23 pin 13-14	Short circuit before energized	230V 0.02A	520V 0.02A	3Min.	--	230V 0.02A	520V 0.02A	Indicate ISO fault, error code "ID56" (The insulation resistance is too low). Do not connect to AC mainsn. No damage, no hazards.
GFCI defect R292	Open	230V 26.2A	520V 12.1A	3Min.	--	230V 0.02A	520V 0.02A	Indicate GFCI fault, error code "ID48" (The GFCI sampling value between the master DSP and slave DSP is not consistent). Do not connect to AC mainsn. No damage, no hazards.
GFCI defect R297	Open	230V 26.2A	520V 12.1A	3Min.	--	230V 0.02A	520V 0.02A	Indicate GFCI fault, error code "ID48" (The GFCI sampling value between the master DSP and slave DSP is not consistent). Do not connect to AC mainsn. No damage, no hazards.

The errors in the control circuit simulate that the safety is even under one error ensured.

The tests had been performed on the HYD 6000-ES is valid for the HYD 5000-ES, HYD 4000-ES, HYD 3600-ES and HYD 3000-ES, since it is similar in hardware and just power derated by software.

Addendum – Shutdown device

Each active phase can be switched. (L and N)

Yes

If no galvanic separation between AC and DC (PV):

Two relays in series on each active phase are necessary to fulfil the basic insulation or simple separation based on the PV working voltage.

Yes

6.2 (4.2) Voltage monitoring							P		
Test conditions:	Output power: 6000W Frequency: 50Hz								
	Under Voltage				Over Voltage				
Parameter	Voltage	Time [ms]			Voltage	Time [ms]			
Limit	184,0V	<= 200ms			264,5V	<= 200 ms			
Trip value	184,2V				264,5V				
Disconnection time	190V to 180V	119	109	116	258V to 268V	134	128	110	
	230V to 180V	133	117	119	230V to 268V	114	118	109	
Reconnection time (fluctuation <=3s):	>= 5s	N/A			>= 5s	N/A			
Reconnection time (fluctuation >3s):	>= 30s	67 s			>= 30s	68 s			
<p>Note:</p> <p>Lower and upper threshold voltage shall not fall or rise below or above 3% of the threshold voltage itself (min. 177,1V; max. 270,9V). The measurement shall take place at nominal frequency and any power.</p> <p>The tests had been performed on the HYD 6000-ES is valid for the HYD 5000-ES, HYD 4000-ES, HYD 3600-ES and HYD 3000-ES, since it is similar in hardware and just power derated by software.</p>									

Under voltage:



Over voltage:



Island 50Hz

6.2 (4.2) Voltage monitoring according protection de Découplage pour le Raccordement d'une production décentralisée en HTA et en BT dans les zones non interconnectées, référentiel technique – SEI REF 04, V5							P		
Test conditions:	Output power: 6000W Frequency: 50Hz								
	Under Voltage					Over Voltage			
Parameter	Voltage	Time [ms]			Voltage	Time [ms]			
Limit	184,0V	<= 200ms			255,3V	<= 200 ms			
Trip value	184,2V				252,2V				
Disconnection time	188V to 178V	161	143	163	250V to 260V	153	166	152	
	230V to 178V	133	116	119	230V to 260V	119	121	127	
Reconnection time (fluctuation <=3s):	>= 5s	N/A			>= 5s	N/A			
Reconnection time (fluctuation >3s):	>= 30s	67 s			>= 30s	67 s			
<p>Note:</p> <p>Lower and upper threshold voltage shall not fall or rise below or above 3% of the threshold voltage itself (min. 177,1V; max. 270,9V). The measurement shall take place at nominal frequency and any power.</p> <p>The tests had been performed on the HYD 6000-ES is valid for the HYD 5000-ES, HYD 4000-ES, HYD 3600-ES and HYD 3000-ES, since it is similar in hardware and just power derated by software.</p>									

Under voltage:

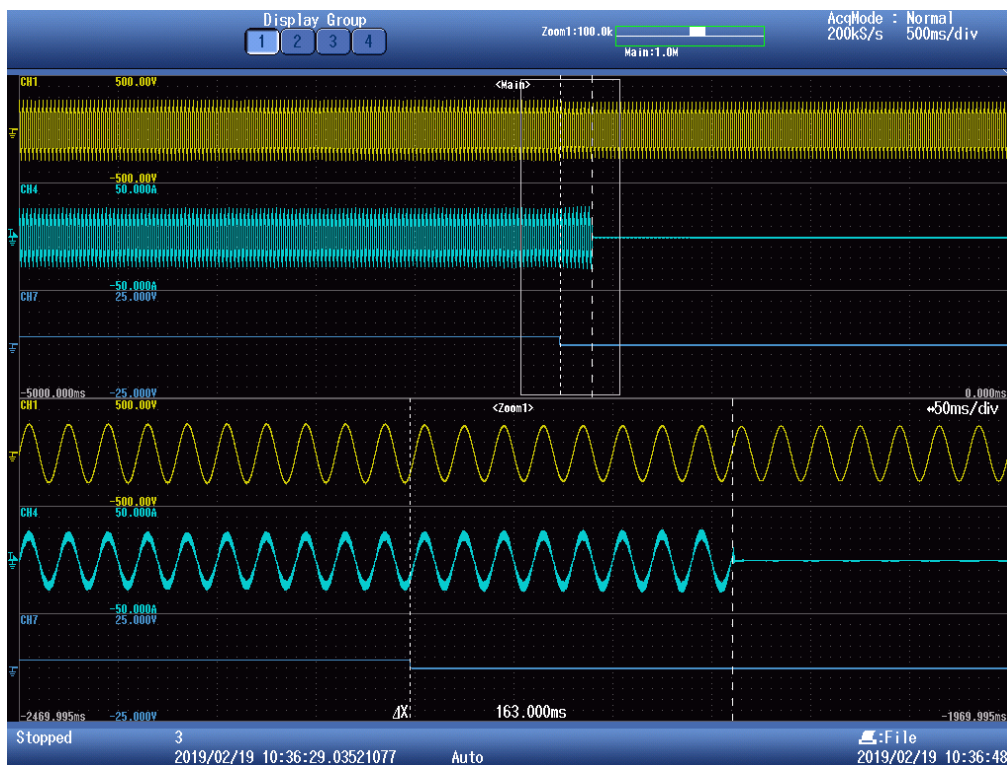

Over voltage:

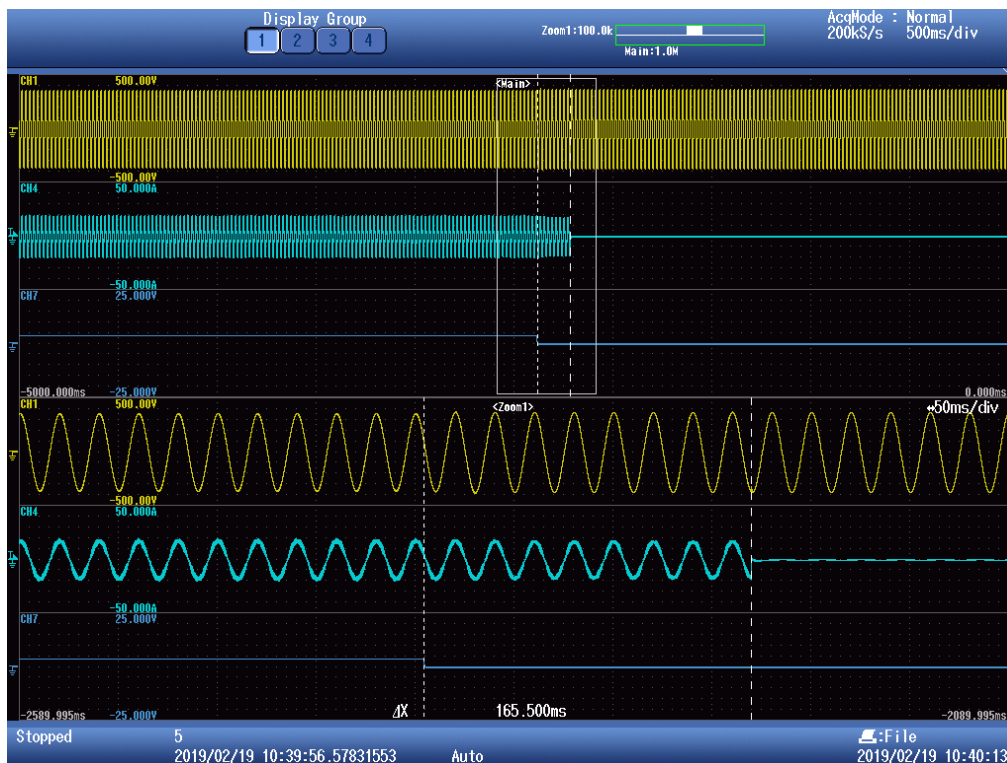

Island 60Hz

6.2 (4.2) Voltage monitoring according contrat de raccordement, d'accès et d'exploitation (CRAE) pour une installation de production photovoltaïque raccordée au réseau public d'électricité							P		
Test conditions:	Output power: 6000W Frequency: 60Hz								
	Under Voltage					Over Voltage			
Parameter	Voltage	Time [ms]			Voltage	Time [ms]			
Limit	195,5V	<= 200ms			264,5V	<= 200 ms			
Trip value	195,1V				261,8V				
Disconnection time	200V to 190V	165	158	157	260V to 270V	142	152	147	
	230V to 190V	108	118	118	230V to 270V	103	109	122	
Reconnection time (fluctuation <=3s):	>= 5s	N/A			>= 5s	N/A			
Reconnection time (fluctuation >3s):	>= 30s	68 s			>= 30s	68 s			
<p>Note:</p> <p>Lower and upper threshold voltage shall not fall or rise below or above 3% of the threshold voltage itself (min. 177,1V; max. 270,9V). The measurement shall take place at nominal frequency and any power.</p> <p>The tests had been performed on the HYD 6000-ES is valid for the HYD 5000-ES, HYD 4000-ES, HYD 3600-ES and HYD 3000-ES, since it is similar in hardware and just power derated by software.</p>									

Under voltage:

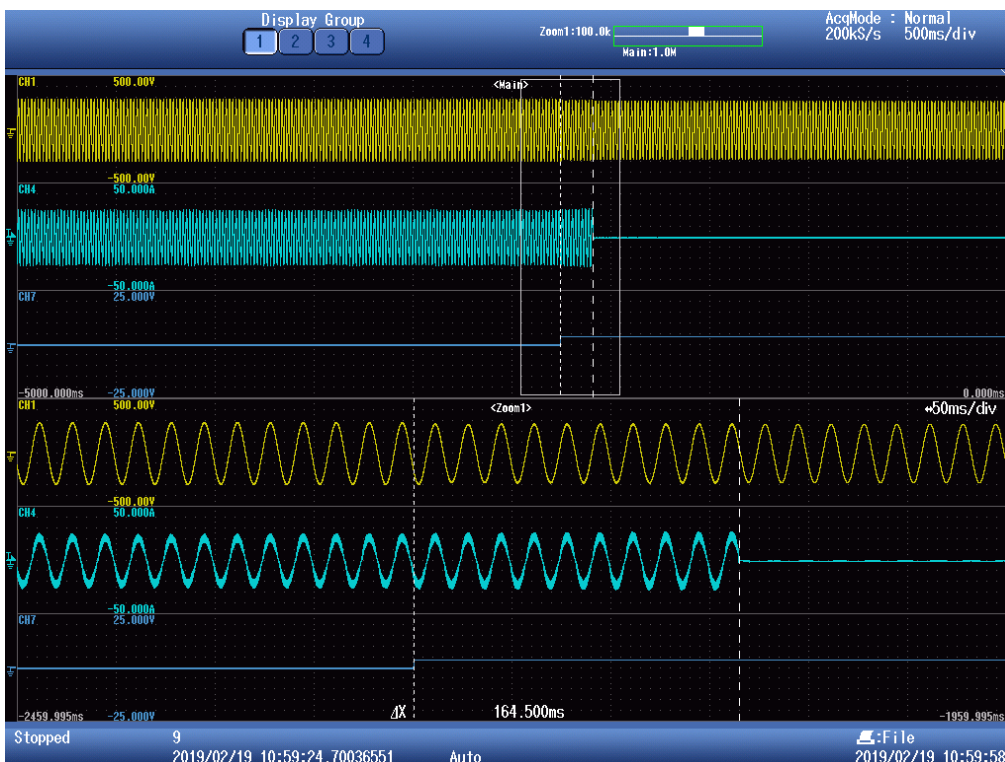

Over voltage:

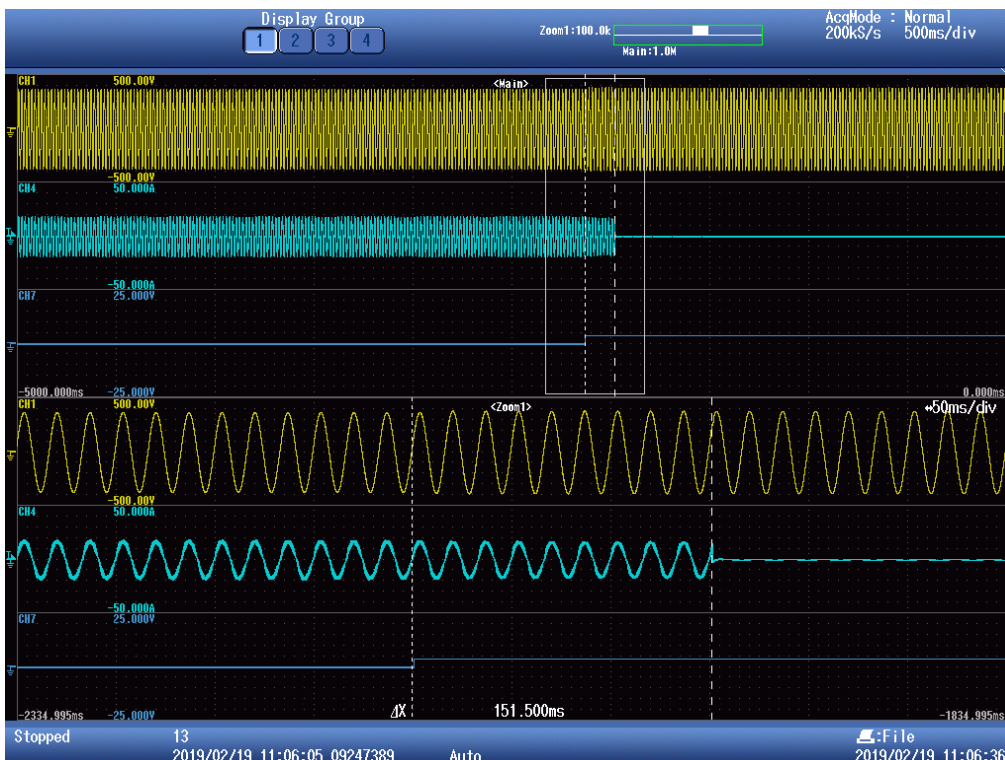

6.2 (4.2.3) Overvoltage protection according to DIN EN 50160:2000-03, 2.3			P
Setting values:	Setting $U >$ [V]	253	
	Setting $T_{\text{disconnection } U >}$ [s]	600	
	Setting $T_{\text{disconnection}}$ [ms]	200	
Test:			
	Disconnection time:	Limit:	
The voltage is set to 100% U_n and held for 600 s. Thereafter the voltage is set to 112% U_n . Disconnection must take place within 600 s.			
a)	Phase 1	500 s	≤ 600 s
	Phase 2	N/A	
	Phase 3	N/A	
The voltage is set to U_n for 600 s and then to 108% U_n for 600 s. No disconnection should take place.			
b)	Phase 1	No disconnection	Disconnection should not take place.
	Phase 2	N/A	
	Phase 3	N/A	
The voltage is set to 106 % U_n and held for 600 s. Thereafter the voltage is set to 114 % U_n . Disconnection must take place within 300 s or about 50 % of the disconnection time measured in point a).*			
c)	Phase 1	292 s	300 s
	Phase 2	--	
	Phase 3	--	
Note:			
The tests had been performed on the HYD 6000-ES is valid for the HYD 5000-ES, HYD 4000-ES, HYD 3600-ES and HYD 3000-ES, since it is similar in hardware and just power derated by software.			

a) Voltage set to 112 % U_n :

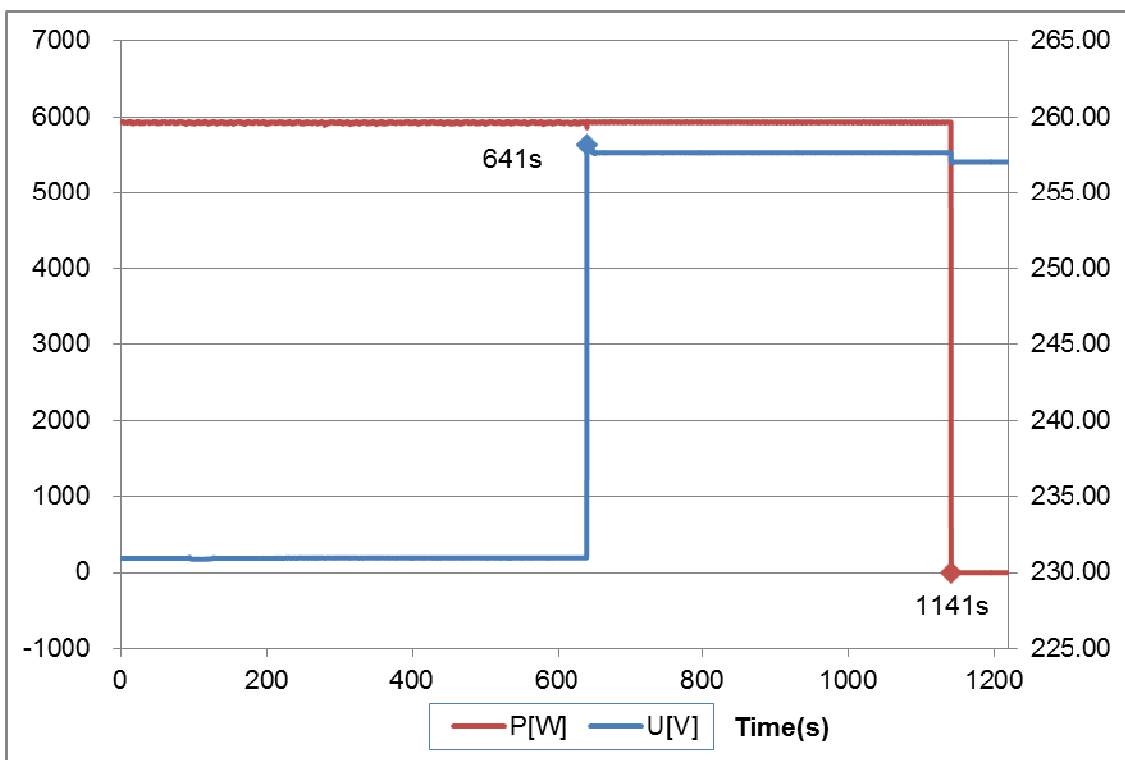

b) Voltage set to 108% U_n :

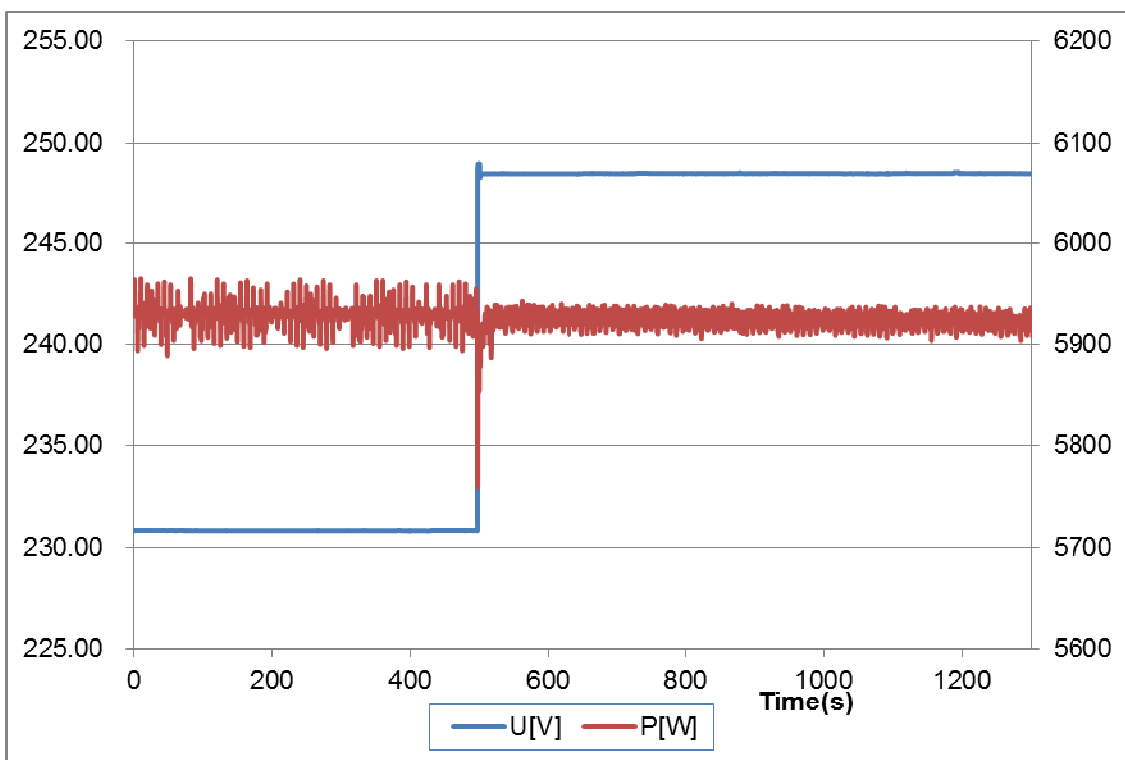

c) Voltage set to 106 % U_n , thereafter 114% U_n :

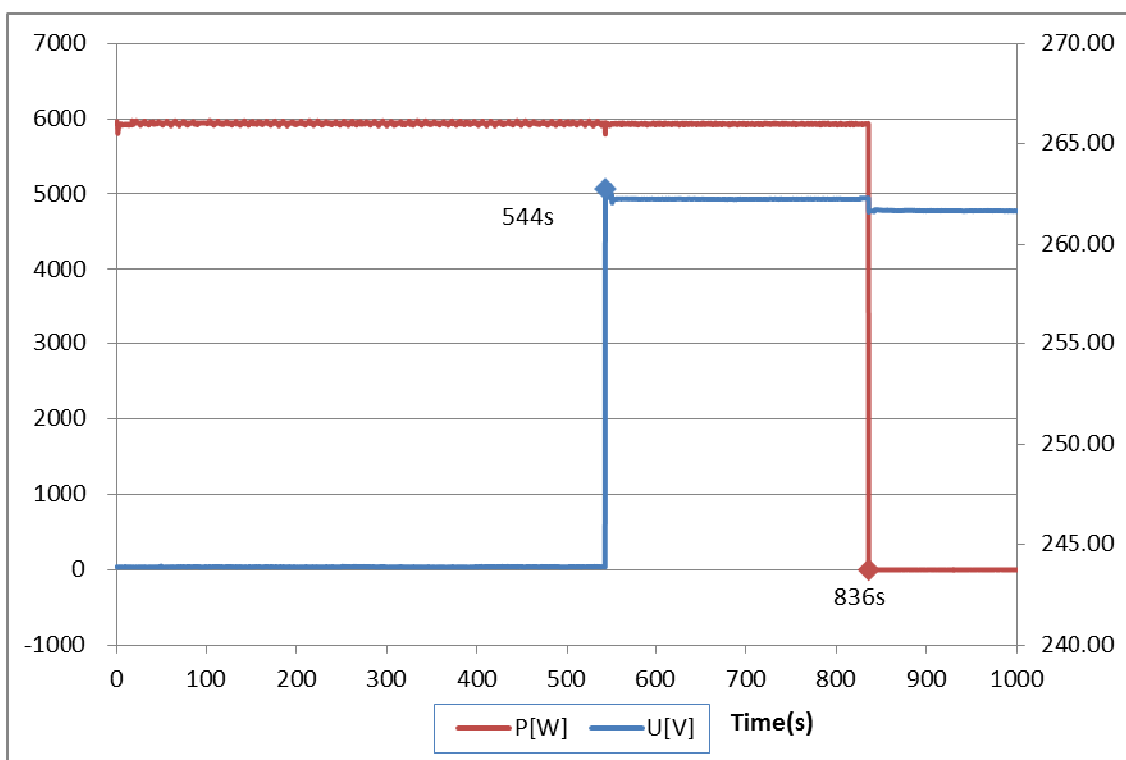

6.3 (4.3) Frequency monitoring DIN V VDE V 0126-1-1/A1 VFR2014							P	
Test conditions:	Output power: 6000W							
	Under frequency				Over frequency			
Parameter	Frequency [Hz]	Time [ms]			Frequency [Hz]	Time [ms]		
Output Voltage		80%U _N	U _N	115%U _N		80%U _N	U _N	115%U _N
Limit	47,5Hz	<= 200ms			50,6Hz	<= 200ms		
Trip value		47,50Hz	47,49Hz	47,49Hz		50,61Hz	50,61Hz	50,61Hz
Disconnection time (ms)	50,00Hz to 47,00Hz	155	190	131	50,00Hz to 51,00Hz	91	93	97
		130	194	145		98	87	92
Reconnection time (fluctuation <=3s):	>= 5s	N/A			>= 5s	N/A		
Reconnection time (fluctuation >3s):	>=30s	63s			>= 30s	66 s		
<p>Note:</p> <p>It was measured at a continuous change of frequency of 1Hz/s at lower, nominal and upper U_N and arbitrary output power. The trip value was determined manually by reducing the frequency in 10mHz steps. When the trip value is known (e.g. 47,50Hz), the ac-source is programmed to run from e.g. 48,00Hz to 47,00Hz with 1Hz/s. The disconnection time is calculated by the measured time minus the 500ms from 48,00Hz to 47,50Hz.</p> <p>The tests had been performed on the HYD 6000-ES is valid for the HYD 5000-ES, HYD 4000-ES, HYD 3600-ES and HYD 3000-ES, since it is similar in hardware and just power derated by software.</p>								

Under frequency:

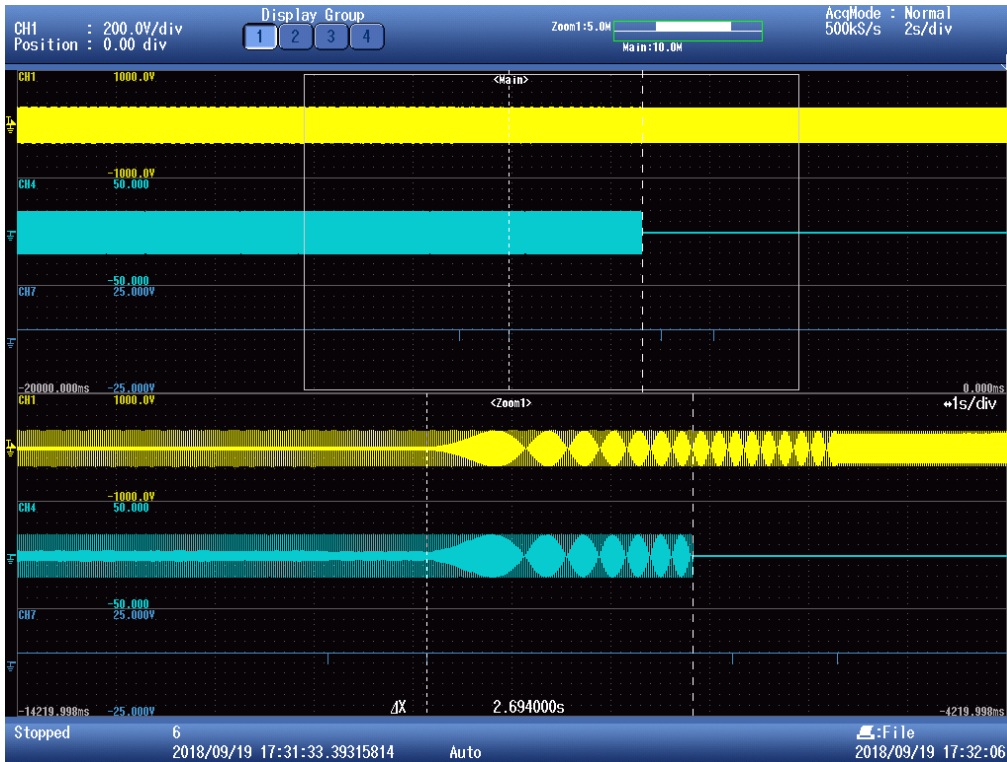

Over frequency:



Island 50Hz

6.3 (4.3) Frequency monitoring according protection de Découplage pour le Raccordement d'une production décentralisée en HTA et en BT dans les zones non interconnectées, référentiel technique – SEI REF 04, V5								P
Test conditions:	Output power: 6000W							
	Under frequency				Over frequency			
Parameter	Frequency [Hz]	Time [ms]			Frequency [Hz]	Time [ms]		
Output Voltage		80%U _N	U _N	111%U _N		80%U _N	U _N	111%U _N
Limit	46,0Hz	200ms	200ms	200ms	52,0Hz	200ms	200ms	200ms
Trip value		45,99Hz	46,00Hz	45,99Hz		52,01Hz	52,01Hz	52,01Hz
Disconnection time (ms)	50,0 Hz to 45,5Hz	123	130	115	50,0 Hz to 52,5Hz	98	104	88
		128	118	120		77	100	91
Reconnection time (fluctuation <=3s):	>= 5s	N/A			>= 5s	N/A		
Reconnection time (fluctuation >3s):	>= 60s	67 s			>= 60s	64 s		
<p>Note:</p> <p>It was measured at a continuous change of frequency of 1Hz/s at lower, nominal and upper U_N and arbitrary output power. The trip value was determined manually by reducing the frequency in 10mHz steps. When the trip value is known (e.g. 46,00Hz), the ac-source is programmed to run from e.g. 46,50Hz to 45,50Hz with 1Hz/s. The disconnection time is calculated by the measured time minus the 500ms from 46,50Hz to 45,50Hz.</p> <p>The tests had been performed on the HYD 6000-ES is valid for the HYD 5000-ES, HYD 4000-ES, HYD 3600-ES and HYD 3000-ES, since it is similar in hardware and just power derated by software.</p>								

Under frequency:



Over frequency:



Island 60Hz

6.3 (4.3) Frequency monitoring according contrat de raccordement, d'accès et d'exploitation (CRAE) pour une installation de production photovoltaïque raccordée au réseau public d'électricité							P	
Test conditions:	Output power: 6000W							
	Under frequency				Over frequency			
Parameter	Frequency [Hz]	Time [ms]			Frequency [Hz]	Time [ms]		
Output Voltage		85%U _N	U _N	115%U _N		85%U _N	U _N	115%U _N
Limit	55,0Hz	200ms	200ms	200ms	62,5Hz	200ms	200ms	200ms
Trip value		54,99Hz	55,00Hz	54,99Hz		62,51Hz	62,51Hz	62,51Hz
Disconnection time (ms)	60,0 Hz to 54,5Hz	103	107	97	60,0Hz to 63,0Hz	69	84	77
		107	109	107		81	84	75
Reconnection time (fluctuation <=3s):	>= 5s	N/A			>= 5s	N/A		
Reconnection time (fluctuation >3s):	>= 60s	65 s			>= 60s	66 s		
<p>Note: It was measured at a continuous change of frequency of 1Hz/s at lower, nominal and upper U_N and arbitrary output power. The trip value was determined manually by reducing the frequency in 10mHz steps. When the trip value is known (e.g. 55,00Hz), the ac-source is programmed to run from e.g. 55,50Hz to 54,50Hz with 1Hz/s. The disconnection time is calculated by the measured time minus the 500ms from 55,50Hz to 54,50Hz.</p> <p>The tests had been performed on the HYD 6000-ES is valid for the HYD 5000-ES, HYD 4000-ES, HYD 3600-ES and HYD 3000-ES, since it is similar in hardware and just power derated by software.</p>								

Under frequency:

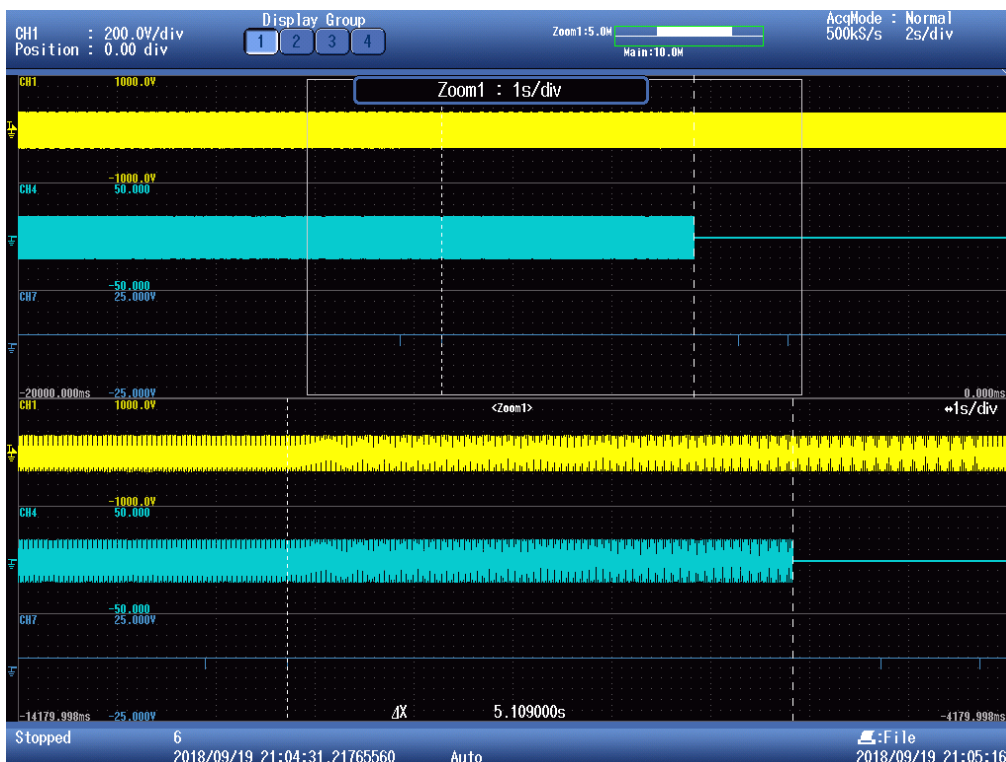

Over frequency:



6.4 (4.4) Monitoring of DC-Injection		P
Test conditions:	$U_N : 230V_{ac}$ $U_{input} : 480V_{dc}$ Rated Power : 2kW	
DC Injection [A]	Limits	Trip Time [ms]
+1A	$I_{dc} > 1A$ than disconnection within 0,2 sec	159
-1A	$I_{dc} > 1A$ than disconnection within 0,2 sec	158
Note: A dc-current of 1A is injected, disconnection time of max. 0,2s The tests had been performed on the HYD 6000-ES is valid for the HYD 5000-ES, HYD 4000-ES, HYD 3600-ES and HYD 3000-ES, since it is similar in hardware and just power derated by software.		

Positive DC-Injection:

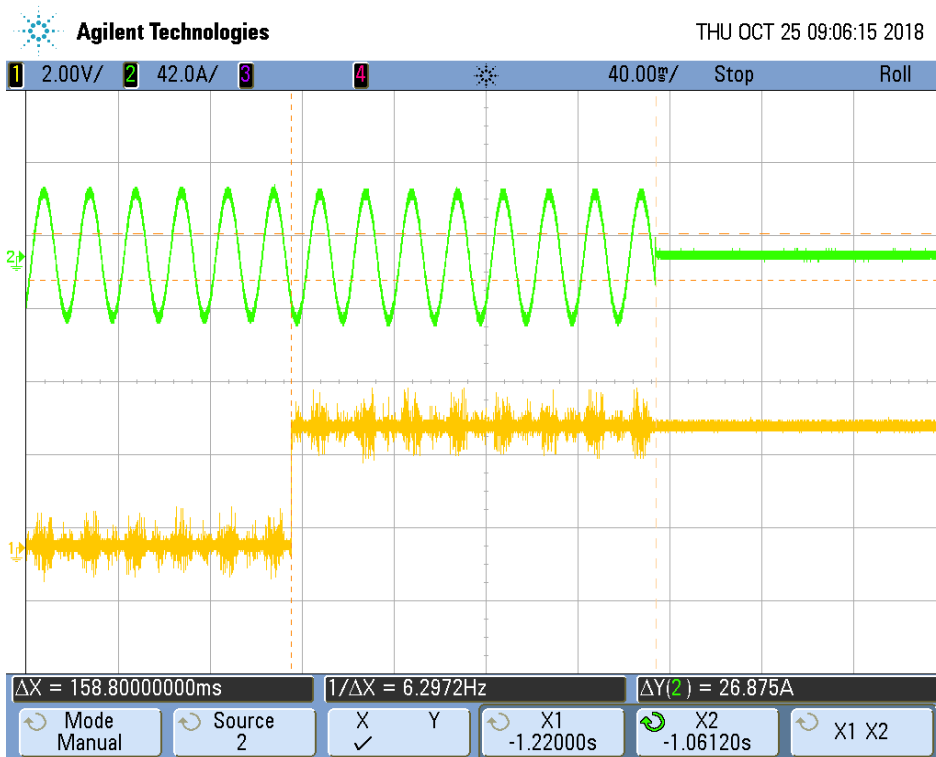

Negative DC-Injection



DC-Injection	P			
---------------------	----------	--	--	--

HYD 3000-ES				
Protection limit	Tested at four power levels limit 0,5% of IAC;nom			
Output power	~20%	~50%	75%	~100%
Abs. Max. test value [A]	0,009	-0,050	-0,047	-0,044
Abs. Ave. test value [A]	0,010	-0,052	-0,051	-0,047

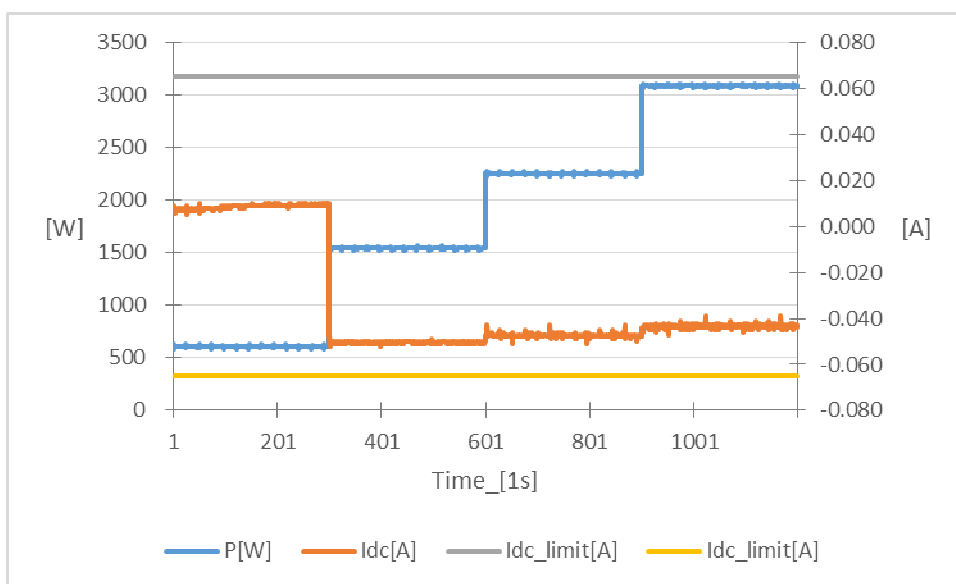

HYD 6000-ES				
Protection limit	Tested at four power levels limit 0,5% of IAC;nom			
Output power	~20%	~50%	75%	~100%
Abs. Max. test value [A]	-0,058	-0,050	-0,042	-0,035
Abs. Ave. test value [A]	-0,054	-0,048	-0,040	-0,029

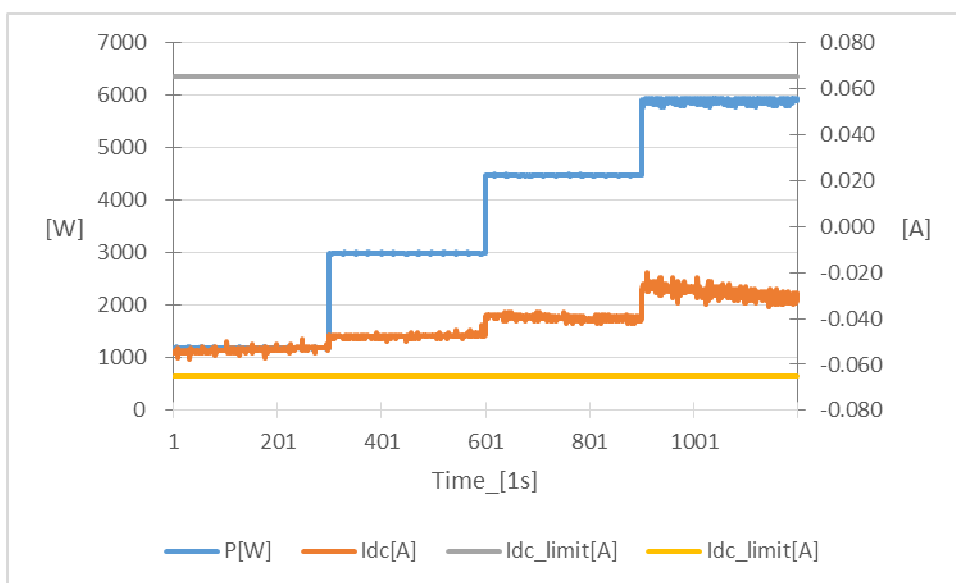

Note:

6.5 (4.5) Detection of Anti-Islanding			P
6.5.2 Resonant circuit test			P
Test conditions:	Frequency: 50+/-0,2Hz $U_N=230\pm 3V_{ac}$ RLC consumes inverter real power within +/-3% Distortion factor of chokes <3% Quality $Q>2$		
Disconnection limit:	5s		
Output power:	25%	50%	100%
Osc. Parameter			
- 5%	313	293	282
- 4%	346	394	290
- 3%	342	367	283
- 2%	463	543	346
- 1%	408	534	450
0 %	382	427	317
+1 %	454	344	447
+2 %	382	342	381
+3 %	513	368	391
+4 %	350	312	273
+5 %	309	170	240
Parameter at 0%	$L= 55,76\text{ mH}$ $R= 36,48\Omega$ $C= 182,92\mu F$	$L= 28,06\text{ mH}$ $R= 17,93\ \Omega$ $C= 361,03\ \mu F$	$L= 14,01\text{ mH}$ $R= 9,00\ \Omega$ $C=723,01\ \mu F$
<p>Note: The capacitors and the Chokes of the resonant circuit were adjusted in order to reach a quality of >2. $P_{QC}+P_{QL}=-P_{Q,WR}$. The resistors of the resonant circuit consumed the real power of the inverter (P_{WR}) within +/- 3%.</p> <p>The tests had been performed on the HYD 6000-ES is valid for the HYD 5000-ES, HYD 4000-ES, HYD 3600-ES and HYD 3000-ES, since it is similar in hardware and just power derated by software.</p>			

25% Power (0,+3)

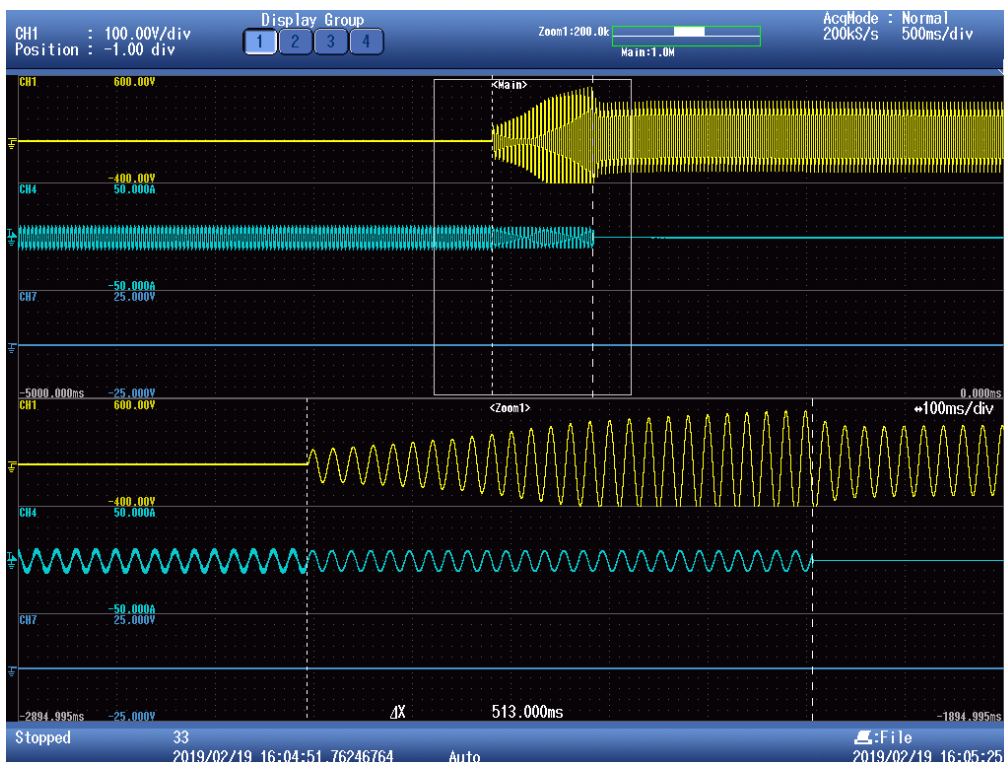

50% Power (0,-2)

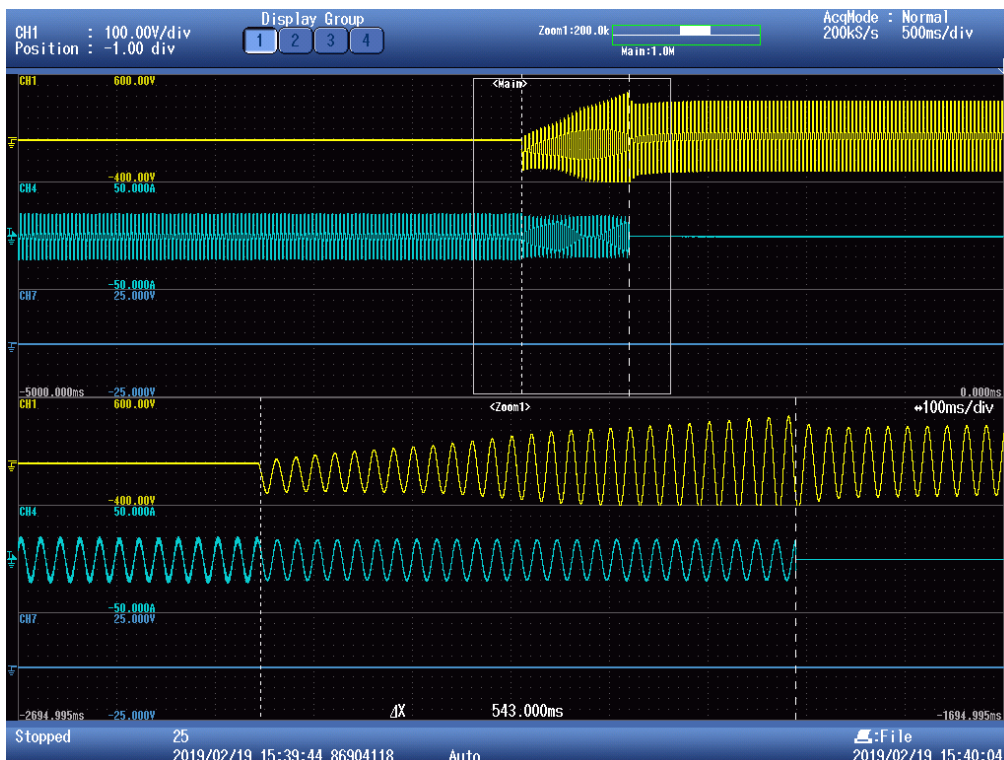

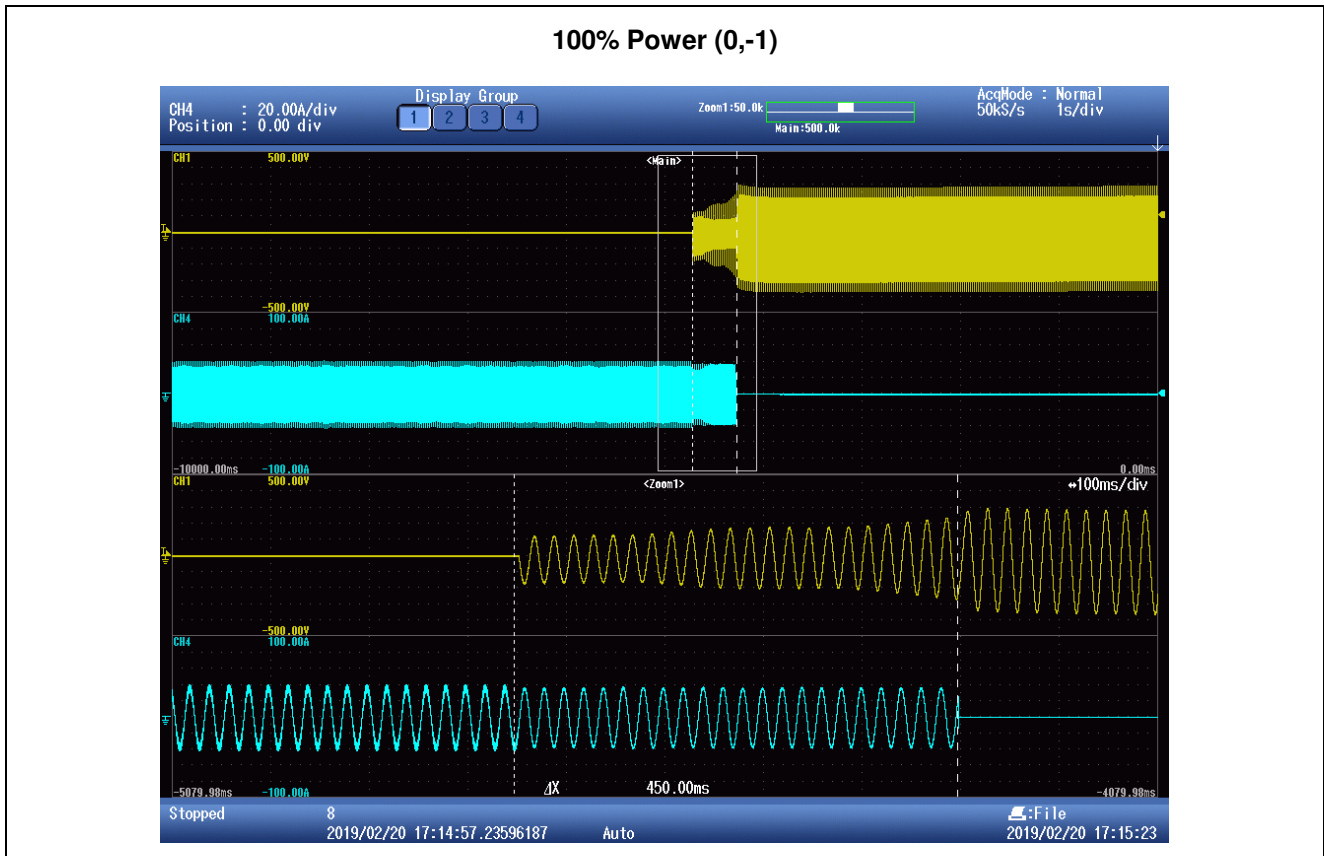

6.6 (4.7) Residual current monitoring		P
Test conditions:	Output power: 6000W V_{DC} : Frequency: 50Hz Current measuring devices: min. class 0,5	
6.6.2.2.2 Test for correct disconnection in case of a continuously rising residual current		P
+ PV to N:		
	Fault Current [mA]	
Limit [mA]	U_N	
≤300	245	
≤300	242	
≤300	243	
≤300	245	
≤300	243	
- PV to N:		
	Fault Current [mA]	
Limit [mA]	U_N	
≤300	246	
≤300	247	
≤300	246	
≤300	245	
≤300	246	
Note: Comparing test circuit at 6.6.2.1, pic. 4. Fault current will rise up to 300mA within 30s. 5 values will be measured and listed.		

6.6.2.2.2 Test for correct disconnection in case of an abrupt appearing residual current >300mA		P
Test conditions:	Output power: 100% V_{DC} : 500V Frequency: 50Hz Current measuring devices: min. class 0,5 Time measuring devices: <10% of the measured value	
+ PV to N:		
Fault Current > 300mA		
Limit [ms]	U_N	
300	262	
- PV to N:		
Fault Current > 300mA		
Limit [ms]	U_N	
300	212	
<p>Note: To test the trip time, the test resistance is then adjusted to set the residual current to a value approximately 10 mA below the actual trip level. A second external resistance, adjusted to cause approximately 20 mA of residual current to flow, is connected through a switch from ground to the same PV input terminal as the first resistance. The switch is closed, increasing the residual current to a level above the trip level determined above. The time shall be measured from the moment the second resistance is connected until the moment the inverter disconnects from the mains, as determined by observing the inverter output current and measuring the time until the current drops to zero.</p>		

6.6.2.2.3 Test for correct disconnection in case of a suddenly occurring residual current		P
+PV to N		
Limit [mA]	U _N	Limit [ms]
	Disconnection time [ms]	
30	217	300
30	202	300
30	201	300
30	216	300
30	218	300
60	106	150
60	104	150
60	113	150
60	108	150
60	112	150
150	34	40
150	37	40
150	28	40
150	34	40
150	34	40
-PV to N		
Limit [mA]	U _N	Limit [ms]
	Disconnection time [ms]	
30	197	300
30	194	300
30	263	300
30	206	300
30	203	300
60	117	150
60	115	150
60	108	150
60	105	150
60	102	150
150	27	40
150	26	40
150	29	40
150	28	40
150	31	40
<p>Note: The capacitive current is risen until disconnection. Test condition: $I_c + 30/60/150\text{mA} \leq I_{c\text{max}}$. R₁ is set that 30/60/150mA Flow and switch S is closed.</p>		

6.6.2.2.4 Isolation measurement before feeding in				P
DC Voltage below minimum operating voltage (V)	DC Voltage for inverter begin operation (V)	Resistance between ground and PV input terminal (Ω)	Required Insulation resistance $R = (V_{MAX PV} / 30mA)$ (Ω)	Result
DC+				
100	120	21K	20K	The PV inverter cannot start-up. Error message: "PV Isolation Low"
100	340	21K	20K	
100	440	21K	20K	
100	600	21K	20K	
DC-				
100	120	21K	20K	The PV inverter cannot start-up. Error message: "PV Isolation Low"
100	340	21K	20K	
100	440	21K	20K	
100	600	21K	20K	
Note: The array insulation resistance to ground shall be not less than 1 k Ω /V with respect to the maximum dc input voltage as specified by the manufacturer, with a minimum of 500 k Ω				

Annex 2

Pictures of the unit

Enclosure front view



Enclosure rear view

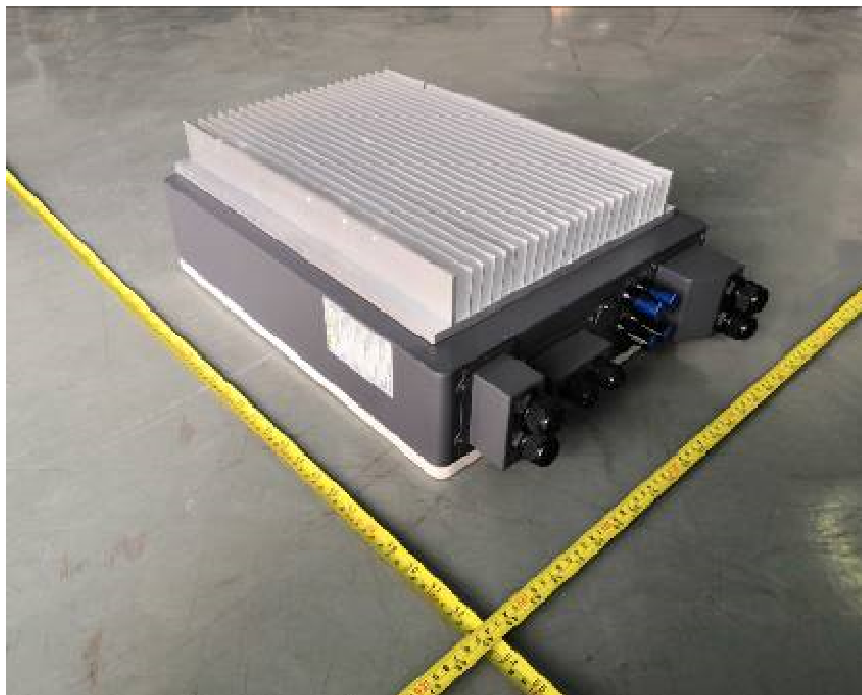

Enclosure Bottom view



Internal view: HYD 6000-ES, HYD 5000-ES

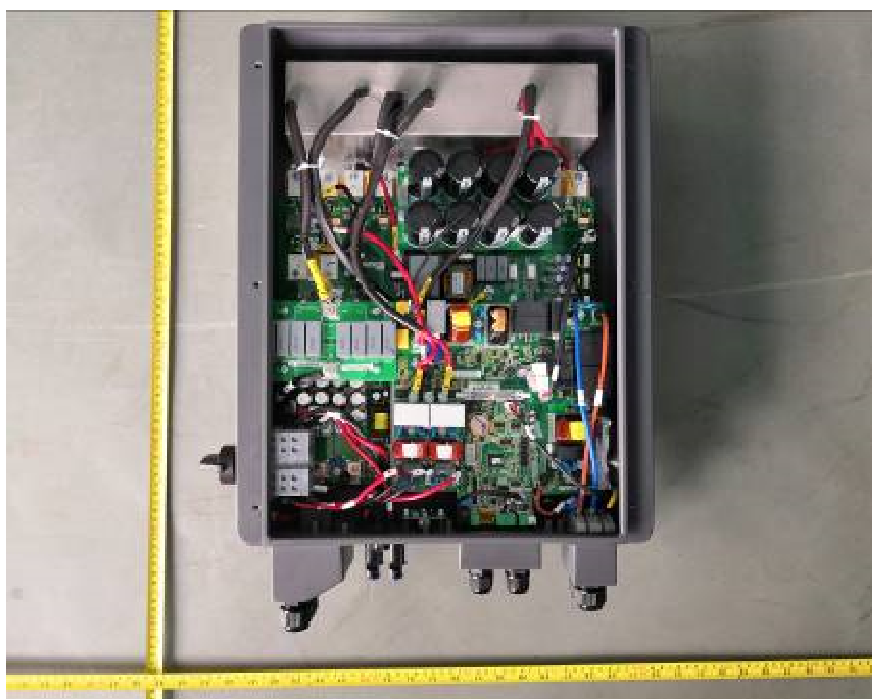

Internal view: HYD 4000-ES, HYD 3600-ES, HYD 3000-ES

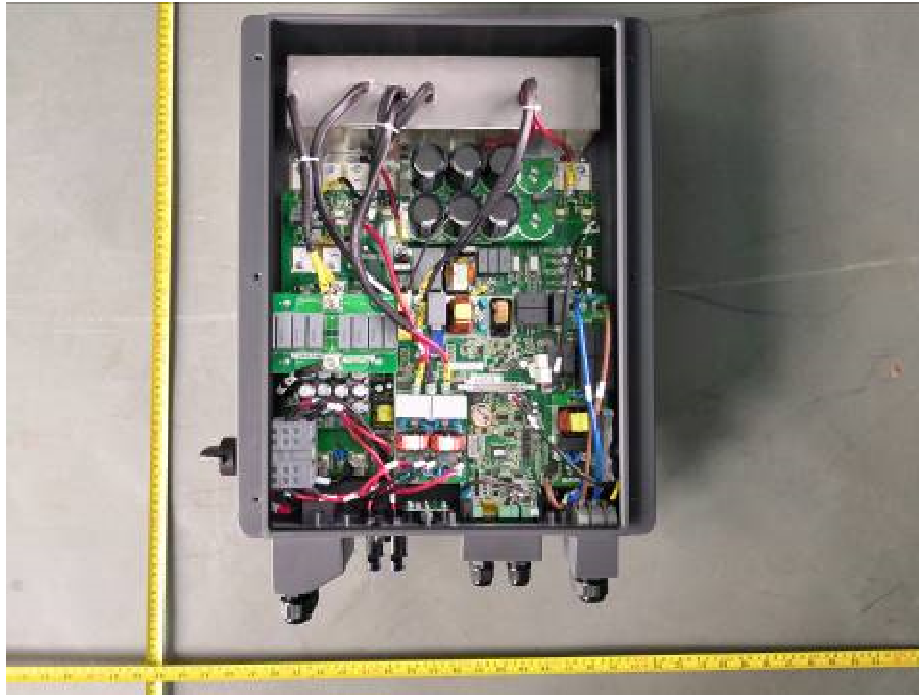

Internal view-1

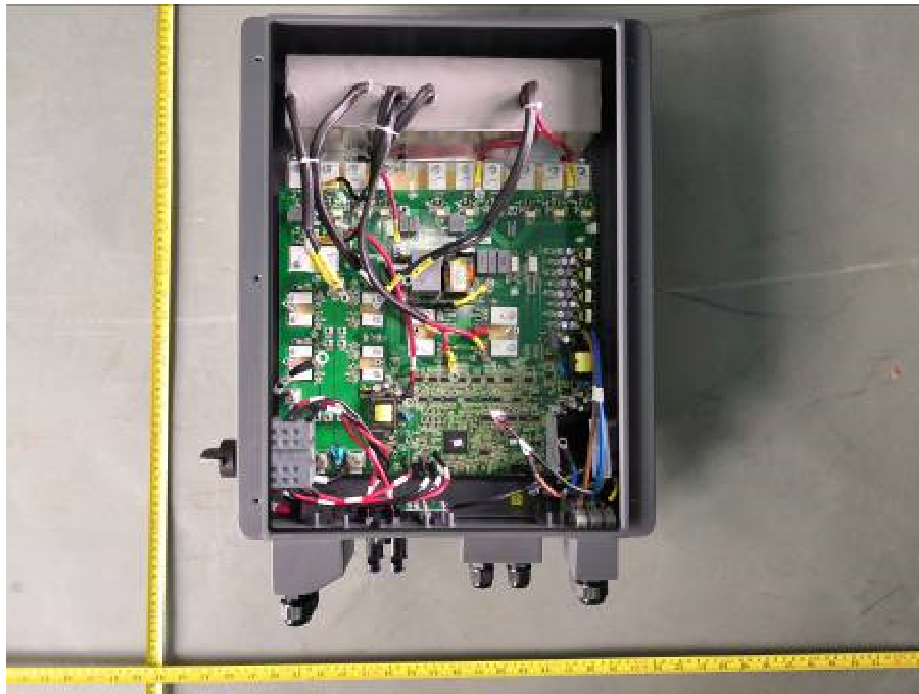

Internal view-2

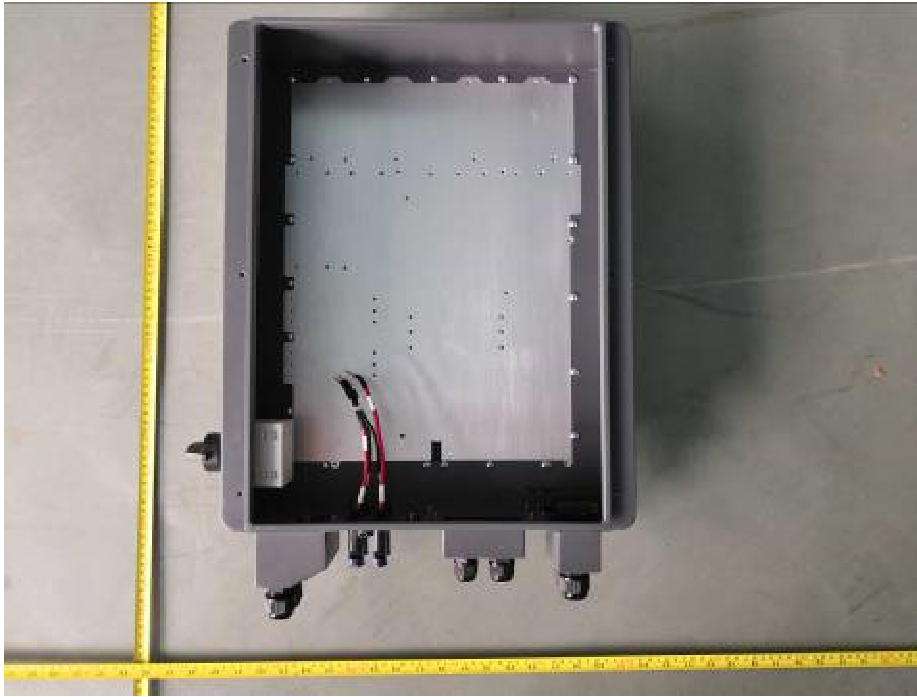

Internal view: Ground terminal



Main power board component side view

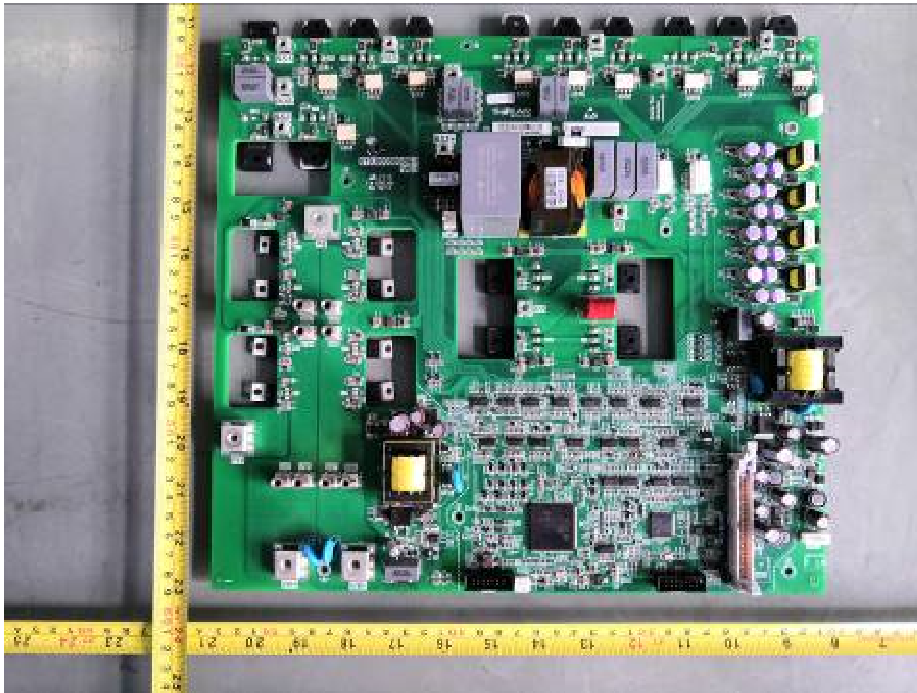

Main power board solder side view

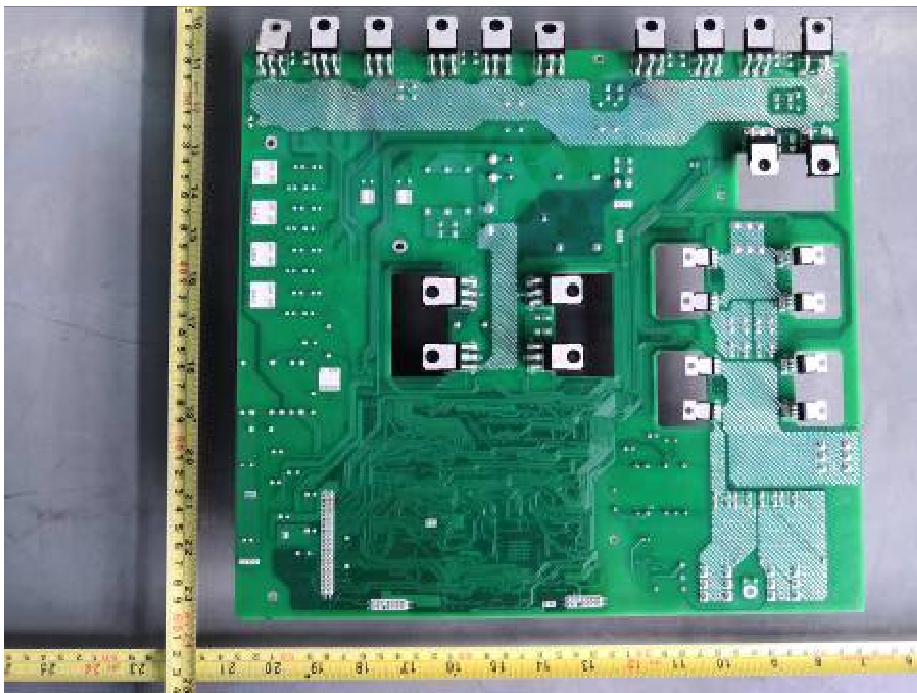

Input&output board component side view



Input&output board solder side view

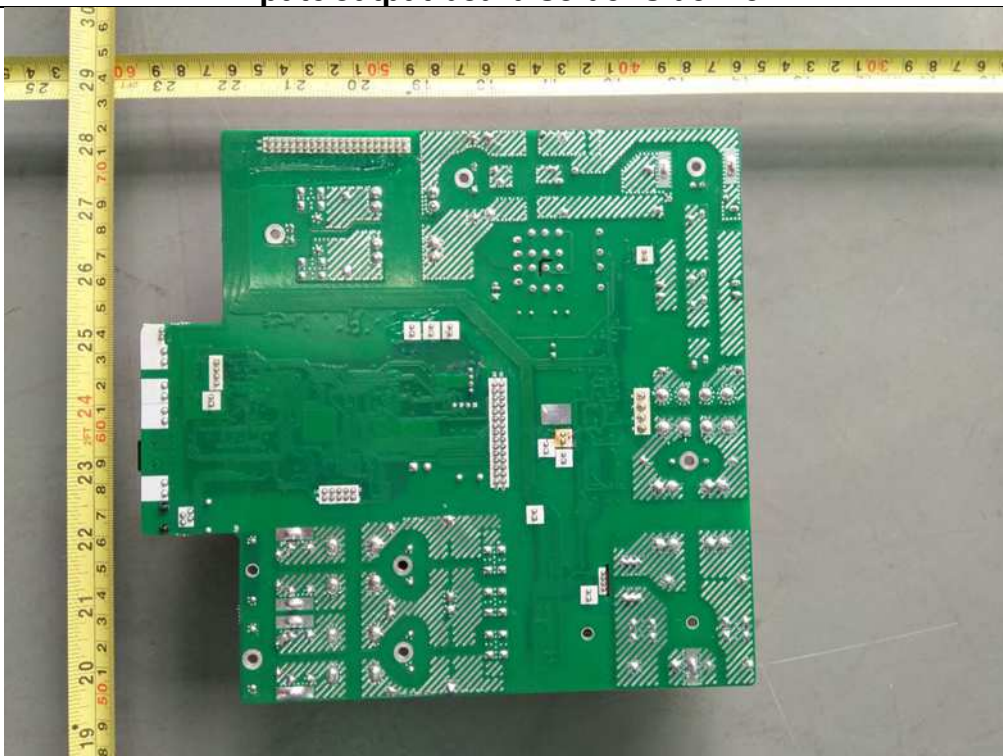

Capcittance board component side view: HYD 6000-ES, HYD 5000-ES



Capcittance board solder side view: HYD 6000-ES, HYD 5000-ES

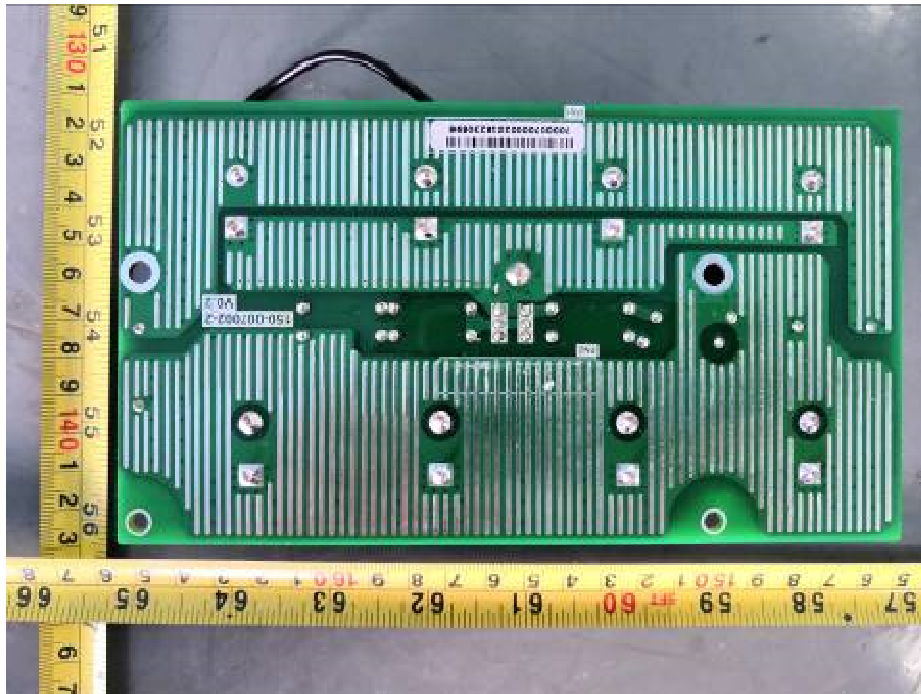

Capcintance board component side view: HYD 4000-ES, HYD 3600-ES, HYD 3000-ES

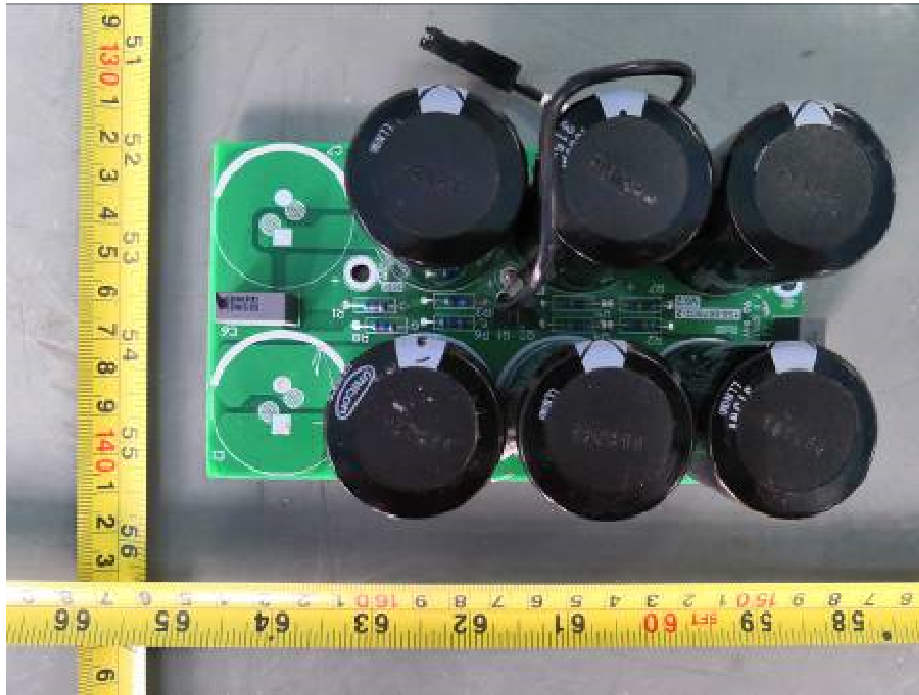

Capcintance board solder side view: HYD 4000-ES, HYD 3600-ES, HYD 3000-ES

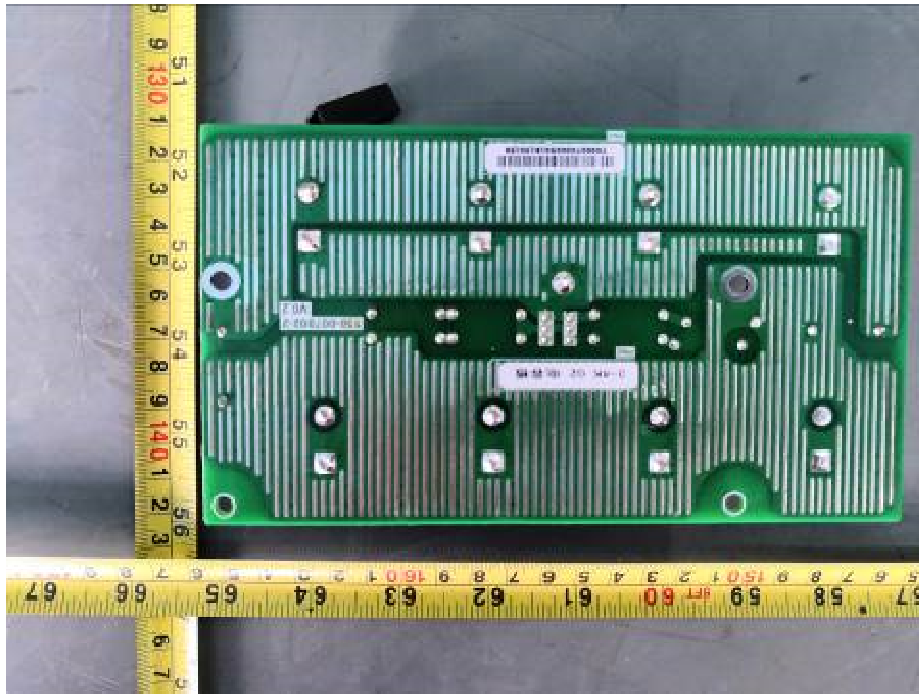

Capcittance B board component side view



Capcittance B board solder side view

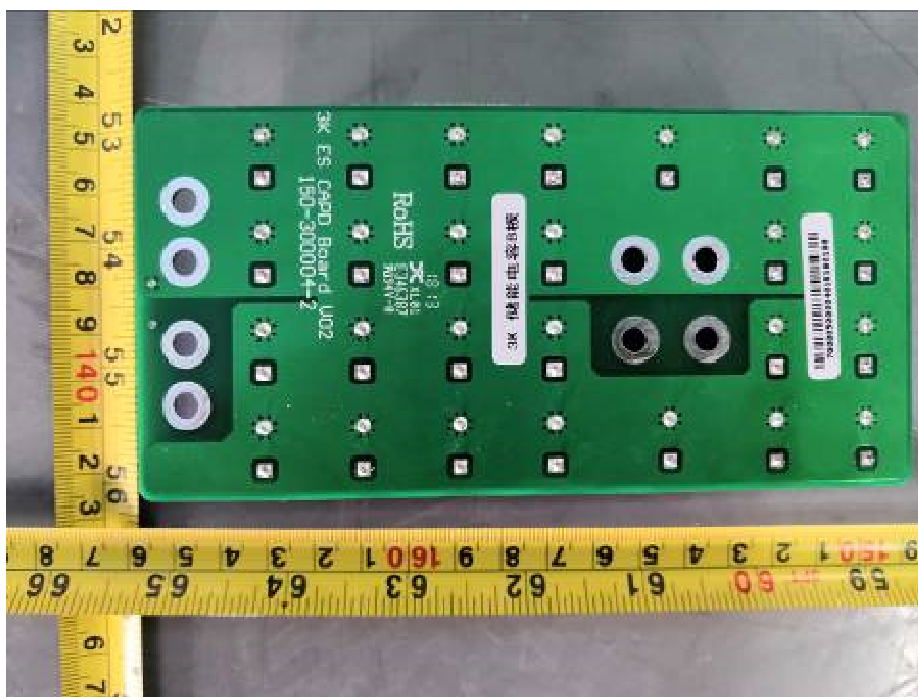

Capcittance A board component side view

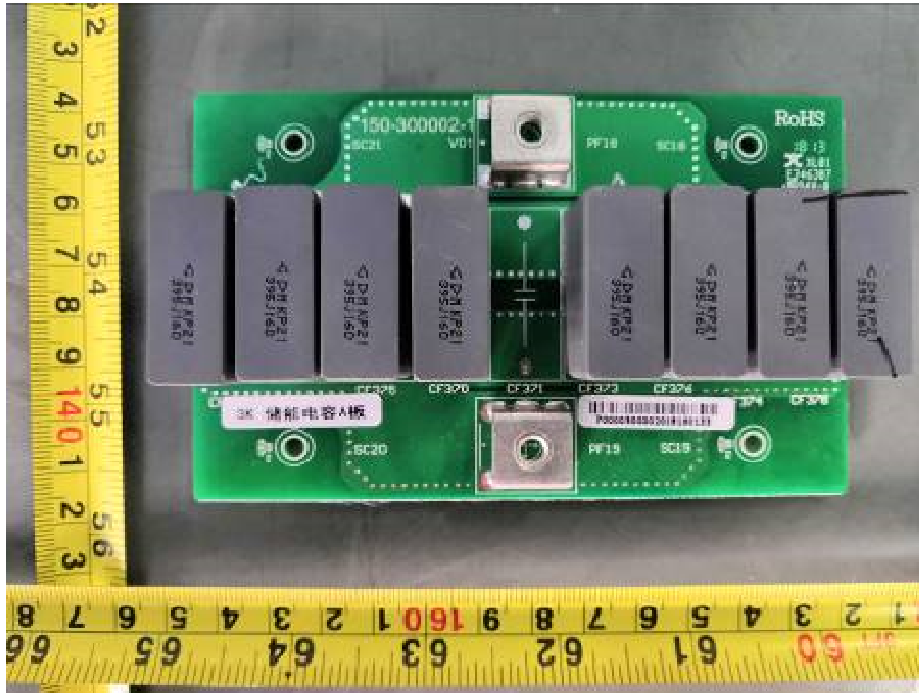

Capcittance A board solder side view

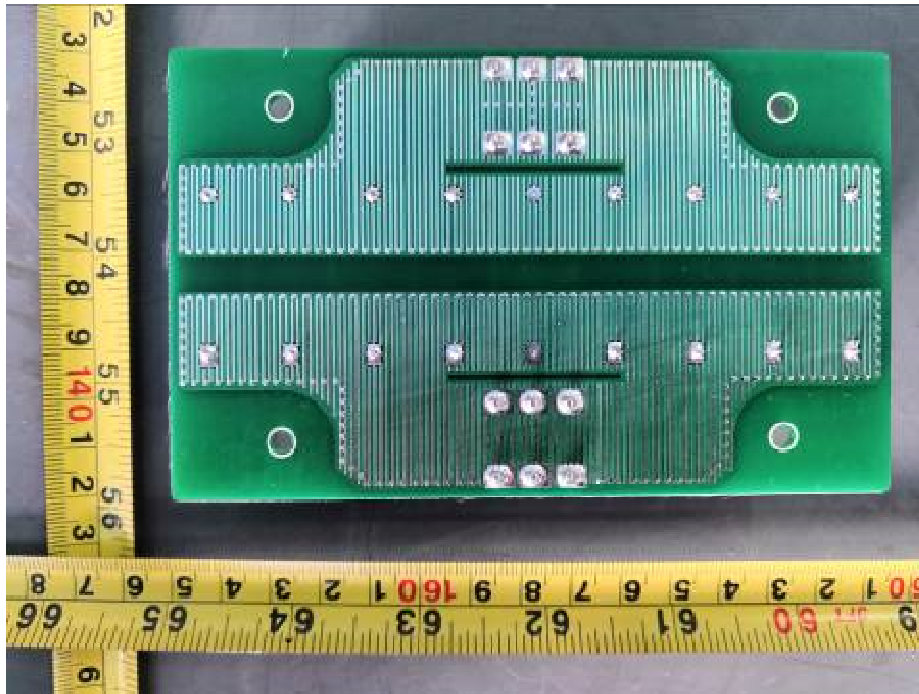

LCD board component side view

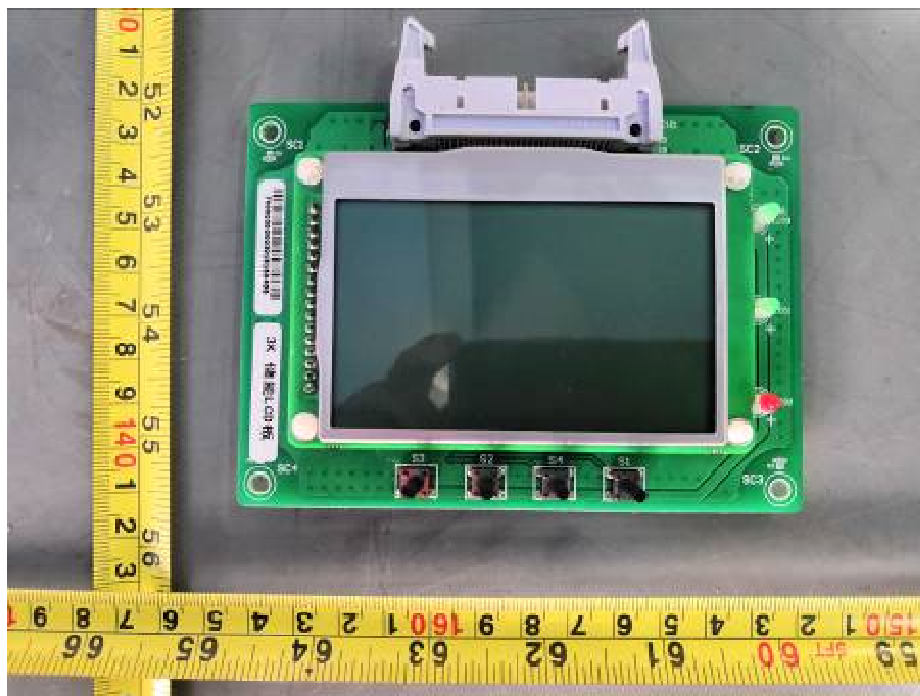

LCD board solder side view

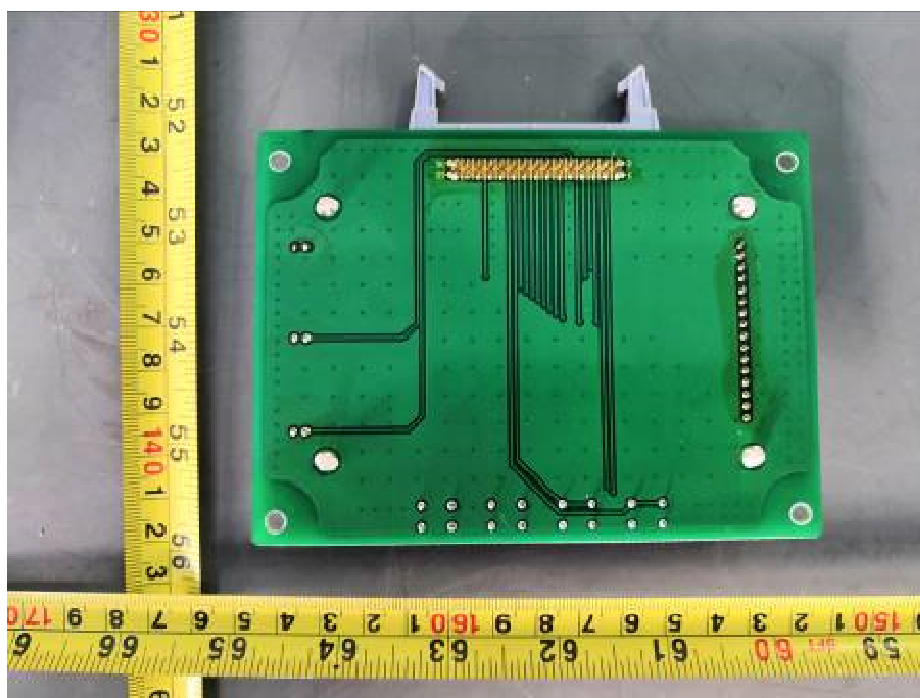

RS232 board component side view



RS232 board solder side view



Annex 3

Test equipment list

Test Local: Bureau Veritas Shenzhen Co., Ltd. Dongguan Branch
Dates of performer test: 2018-09-03 to 2019-02-20

Equipment	Internal No.	Manufacturer	Type	Serial No.	Last Calibration
Power Analyzer	A4080002DG	YOKOGAWA	WT3000	91M210852	Dec. 13, 2018
AC Source	A7040019DG	Chroma	61512	61512000439	Monitored by Power Analyzer
AC Source	A7040020DG	Chroma	61512	61512000438	
DC Simulation	A7040015DG	Chroma	62150H-1000S	62150EF00488	
Power Supply	A7040016DG	Chroma	62150H-1000S	62150EF00490	
RLC Load	A7150027DG	Qunling	ACLT-3803H	93VOO2869	
Digital Phosphor Oscilloscope	A4089017DG	YOKOGAWA	DL850-H-HC	91N726247	Sep. 14, 2018
Isolation voltage probe	A1490008DG	YOKOGAWA	701901	//	Nov 01, 2018
	A1490011DG	YOKOGAWA	701901	//	Nov 01, 2018
Current transducer	A1060009DG	YOKOGAWA	CT200	1130700019	Nov. 17, 2018
	A1060008DG	YOKOGAWA	CT200	1130700017	Nov. 17, 2018
Impulse test generator	A6600005DG	Compliance West	1.2x50-7P	432403	Dec. 07, 2018
Spring Hammer	B3040010DG	Riseray Electronics	RE-3015-2J	--	May 06, 2018